

## A2 LEVEL BIOLOGY NOTES 2016 -2018

### INTRODUCTION

Hello, this is the summary of **A2 Level Biology (CIE)** for 2016-2018 exam.  
As references, I am using the books:

[Cambridge International A/AS-level Biology Revision Guide](#) by Mary Jones

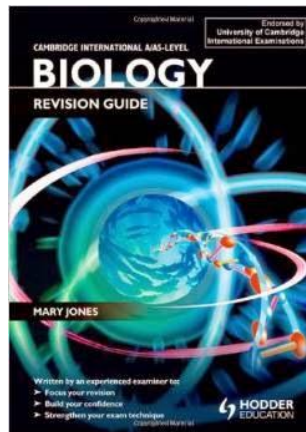

[Cambridge International A/AS-level Biology course book](#) third edition by Mary Jones

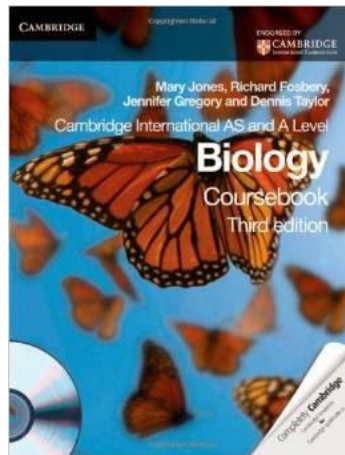

and other resources from Internet.

Credits to authors of pictures and video used for illustration purpose on this blog.

Happy revising and good luck!

E.L.

## CHAPTER 14- ENERGY AND RESPIRATION

### #70 Energy and ATP

All living organisms need a continuous supply of energy to maintain their metabolism. They must absorb either light energy in photosynthesis or chemical potential energy to do the work necessary to stay alive.



Such work includes:

- **Anabolic reactions:** the synthesis of proteins and other large molecules from smaller ones (e.g. polypeptides from amino acids)
- **Active transport** of ions and molecules across cell membranes against their concentration gradient (e.g. the activity of the sodium–potassium pump need energy as against concentration gradient)
- **Movement (mechanical work):** movement of the whole organism for example muscle contraction (such as heart beat, breathing movements, walking) or movement within the organism, e.g. movement of organelles in cells)
- **Maintenance of body temperature**, particularly in mammals and birds, which must release **thermal energy** to maintain the body temperature above that of the environment.
- Transmission of nerve impulses.

Photosynthesis transfers **light energy** into **chemical potential energy**, which can then be released for work by the process of respiration. Both photosynthesis and respiration involve an important intermediary molecule in this energy transfer: adenosine triphosphate (ATP). In many living organisms, most of the energy transferred to ATP is derived originally from light energy; a few prokaryotes (the chemoautotrophs) are not dependent on light energy trapped by photosynthesis but use energy from inorganic chemical reactions instead.

## ATP

### 1. Structure

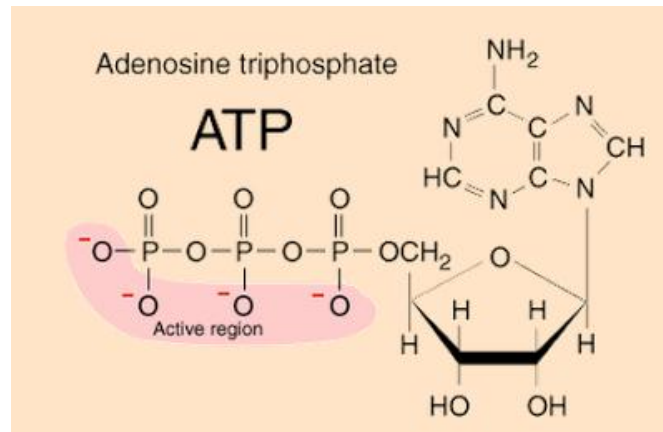

ATP consists of the organic base **adenine** and the pentose sugar **ribose**. Together these make the nucleoside **adenosine**. This is combined with **three phosphate groups**. ATP is therefore an activated phosphorylated **nucleotide**.

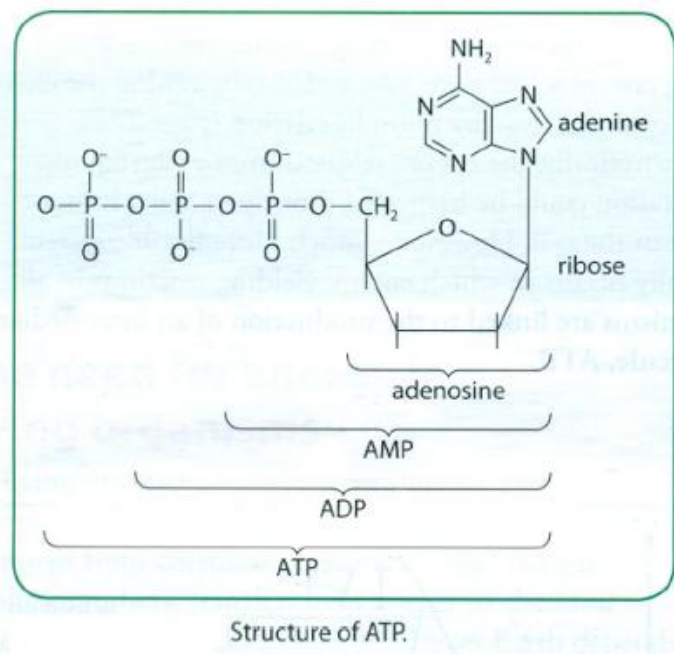

### 2. The universal energy currency

Processes in cells that require energy are linked to chemical reactions that yield energy by an intermediary molecule, ATP. Using one type of molecule to transfer energy to many different energy-requiring processes makes it easier for these processes to be controlled and coordinated. All organisms use ATP as their energy currency: it is a universal energy currency. ATP is never stored. Glucose and fatty acids are short-term energy stores, while glycogen, starch and triglycerides are long-term stores.

When an ATP molecule is hydrolysed, losing one of its phosphate groups, some of this energy is released and can be used by the cell. In this process, the ATP is converted to ADP (adenosine diphosphate). The hydrolysis of one ATP molecule releases a small 'packet' of energy that is often just the right size to fuel a particular step in a process. A glucose molecule, on the other hand, would contain far too much energy, so a lot would be wasted if cells used glucose molecules as their immediate source of energy.

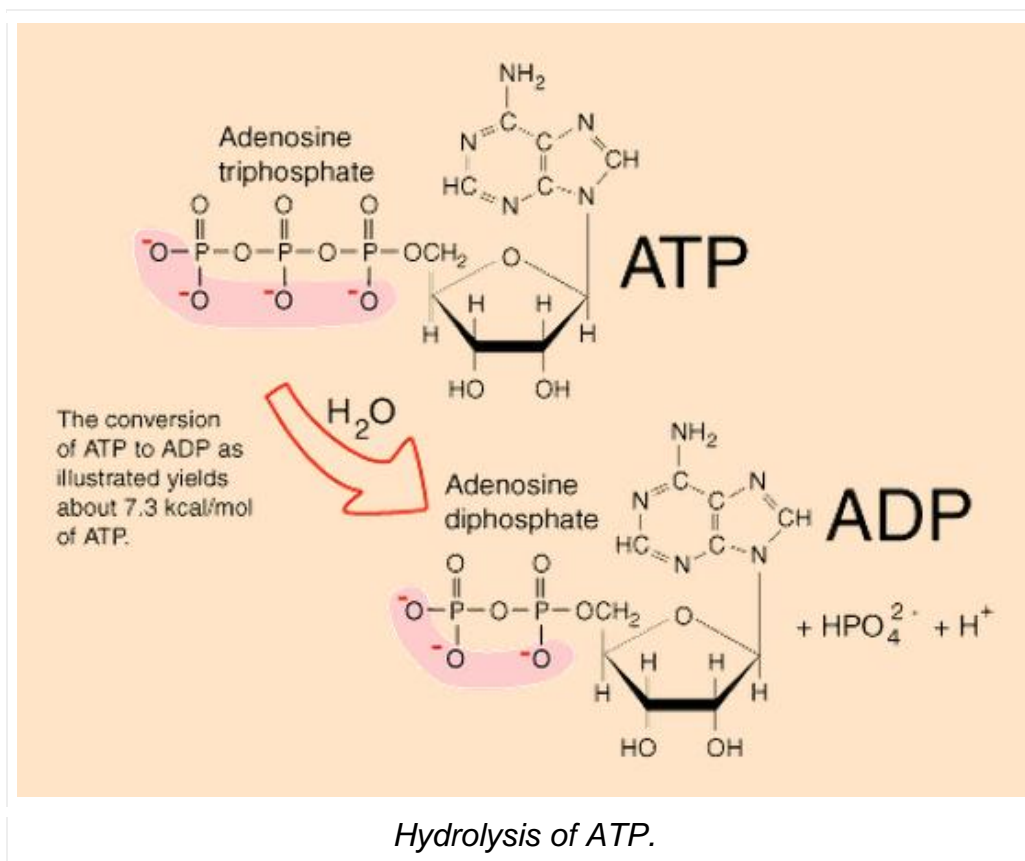

ATP can be synthesised from ADP and an inorganic phosphate group ( $\text{P}_i$ ) using energy, and hydrolysed to ADP and phosphate to release energy. This interconversion is all-important in providing energy for a cell. Hydrolysis of the terminal phosphate group of ATP releases  $30.5 \text{ kJ mol}^{-1}$  of energy for cellular work:

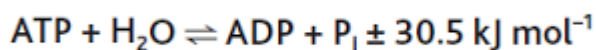

Removing the second phosphate, giving AMP, also releases  $30.5 \text{ kJ mol}^{-1}$  of energy, but removing the last phosphate yields only  $14.2 \text{ kJ mol}^{-1}$ . The energy released comes not simply from these bonds, but from the chemical potential energy of the molecule as a whole.

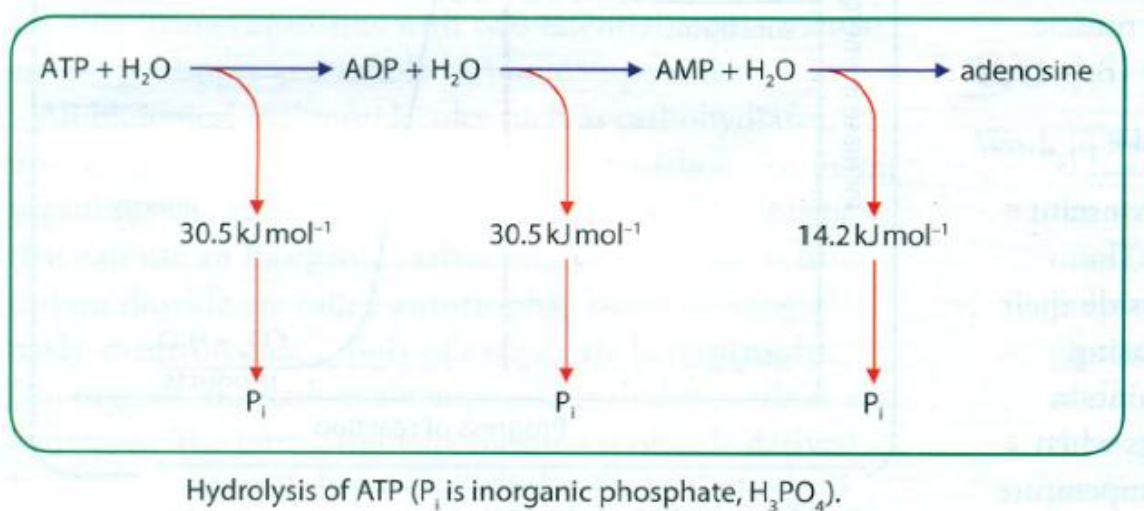

Each cell has only a tiny quantity of ATP in it at any one time. The cell does not import ATP, adenosine diphosphate (ADP) or adenosine monophosphate (AMP). With few exceptions, each cell must produce its own ATP by respiration and recycle it very rapidly. Because it is a small, watersoluble molecule, it is easily moved from where it is made in a cell to where it is needed.

### 3. The roles

- binding to a protein molecule, changing its shape and causing it to fold differently, to produce movement, e.g. muscle contraction
- binding to an enzyme molecule, allowing an energy-requiring reaction to be catalysed
- transferring a phosphate group to an enzyme, making the enzyme active
- transferring a phosphate group to an unreactive substrate molecule so that it can react in a specific way, e.g. in glycolysis and the Calvin cycle
- transferring AMP to an unreactive substrate molecule, producing a reactive intermediate compound, e.g. amino acids before binding to tRNA during protein synthesis
- binding to a trans-membrane protein so that active transport can take place across the membrane.

#### ATP made, moved around and used in most cells:

- ATP produced using energy from respiration reactions
- Breaks down to release energy when required  $ATP \rightarrow ADP + P_i + \text{energy}$
- It is an immediate source of energy released in small 'packets'
- Rapid turnover of ATP with anabolic and catabolic processes
- Uses eg. active transport/Na pump/cell division/phosphorylation

## Metabolism

The total of all the biochemical reactions needed for an organism to stay alive is its metabolism.

$$\text{metabolism} = \text{anabolism} + \text{catabolism}$$

**Anabolism** is the building up of more complex molecules from simpler ones, for example the synthesis of nucleic acids and carbohydrates. Enzymes are needed for these syntheses of the complex molecules needed for growth. Anabolic reactions are energy-consuming.

**Catabolism** is the enzymic breakdown of complex molecules to simpler ones. It is the opposite of anabolism. The catabolic reactions of respiration yield energy.

### Metabolic pathways

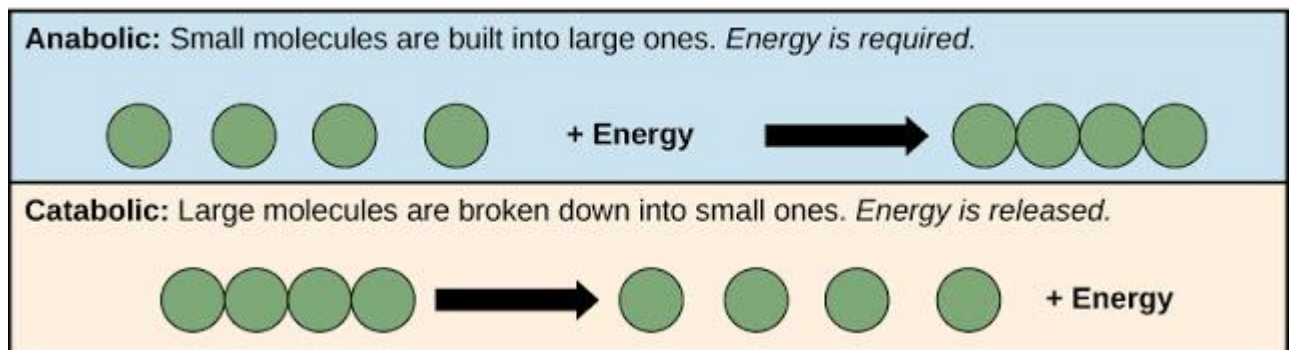

## #71 Respiration, Glycolysis

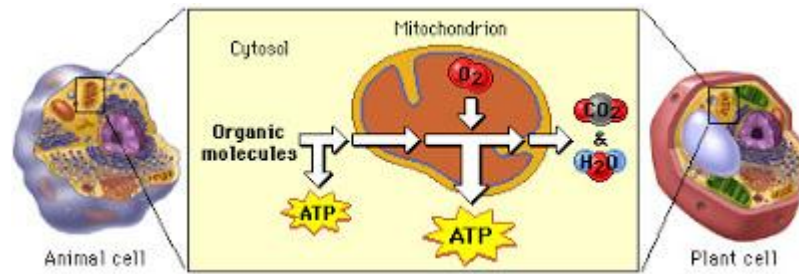

Respiration is the oxidation of energy-containing organic molecules. The energy released from this process is used to combine ADP with inorganic phosphate to make ATP.

All cells obtain useable energy through respiration. Most cells use carbohydrate, usually **glucose**, as their fuel. Some cells, such as nerve cells, can only use glucose as their respiratory substrate, but others can use **fatty acids**, **glycerol** and **amino acids**.

Respiration may be aerobic or anaerobic. In both cases, glucose or another respiratory substrate is oxidised.

- In **aerobic** respiration, oxygen is involved, and the substrate is oxidised completely, releasing much of the energy that it contains.
- In **anaerobic** respiration, oxygen is not involved, and the substrate is only partially oxidised. Only a small proportion of the energy it contains is released.

Respiration of glucose has 4 main stages:

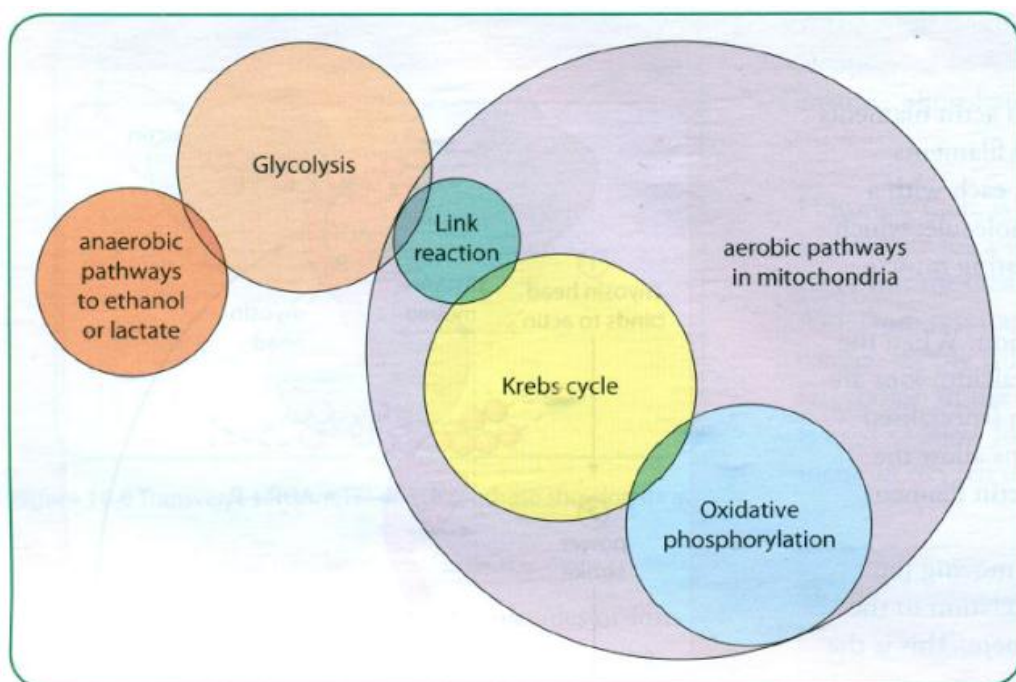

The sequence of events in respiration.

- **glycolysis** in the cytoplasm (cytosol) of the cell
- the **link reaction** in the matrix of a mitochondrion
- the **Krebs cycle** in the matrix of a mitochondrion
- **oxidative phosphorylation** on the inner mitochondrial membrane.

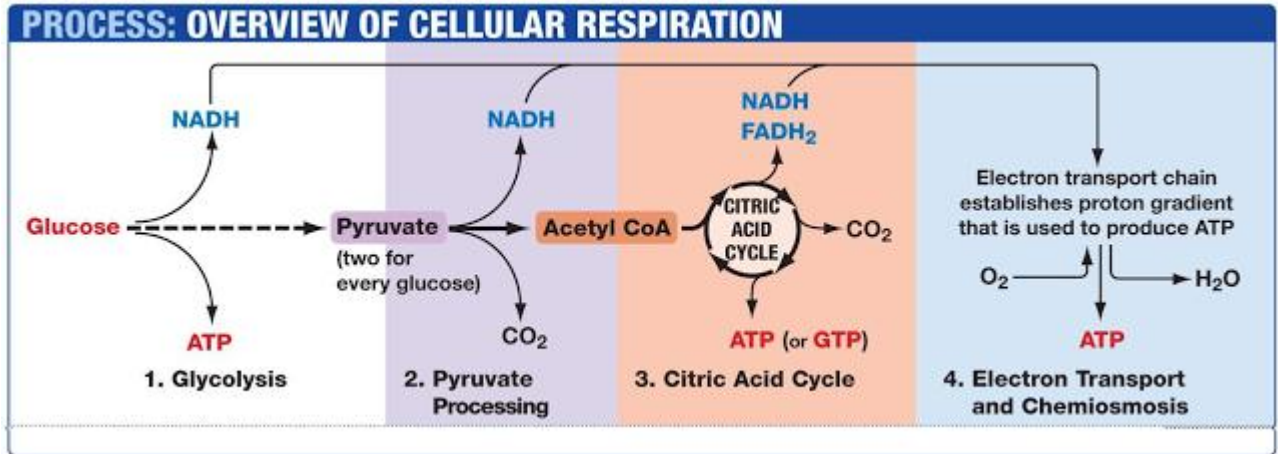

## AEROBIC RESPIRATION

### Glycolysis

Glycolysis (the breakdown of glucose) is the first stage of respiration. It takes place in the cytoplasm and does not require oxygen. It begins with the **6-carbon** ring-shaped structure of a single **glucose** molecule and ends with 2 molecules of a **3-carbon** sugar called **pyruvate** and a net gain of 2 ATP. Glycolysis is summarised below.

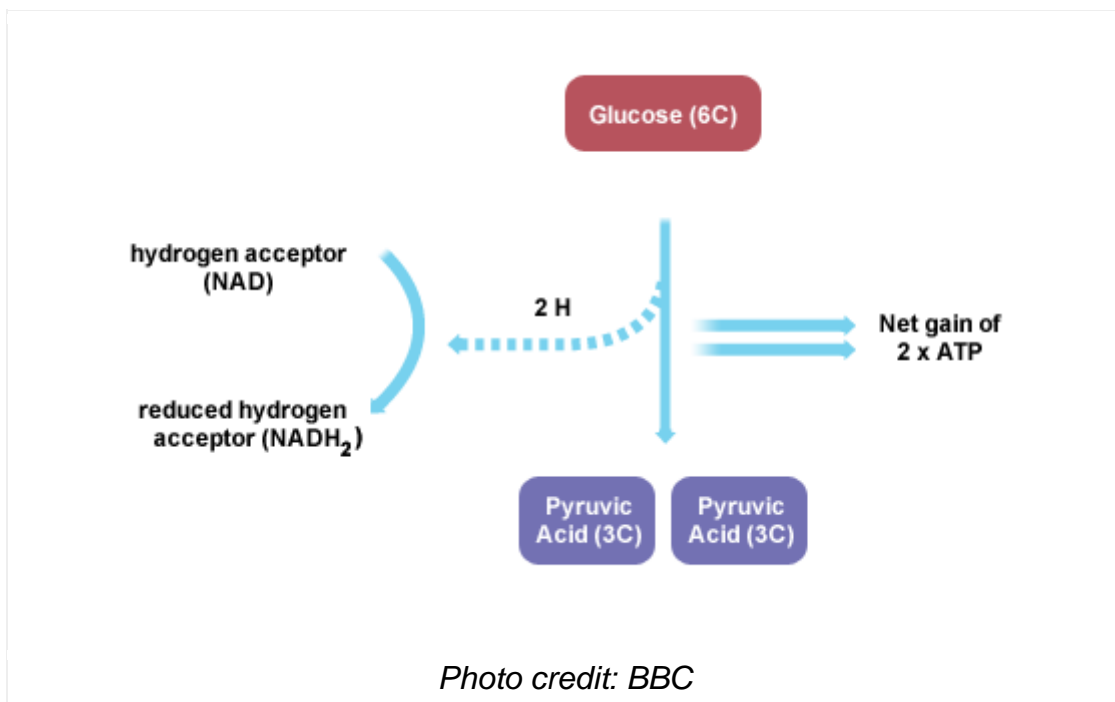



- A **glucose** (or other hexose sugar) is phosphorylated, using phosphate from 2 molecules of ATP, to give **hexose biphosphate**. This **phosphorylation** converts an energy-rich but unreactive molecule into one that is much more reactive, the chemical potential energy of which can be trapped more efficiently.

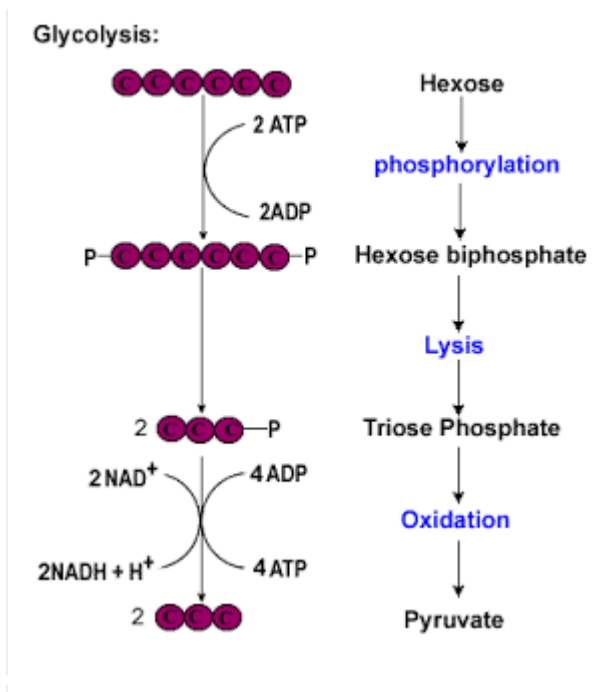

- The hexose bisphosphate is split into 2 **triose phosphate** molecules.
- Hydrogen atoms and phosphate groups are removed from the triose phosphate (by the coenzyme NAD). The removal of hydrogens is an oxidation reaction, so triose phosphate is oxidised to 2 molecules of **pyruvate** (pyruvic acid). During this step, the phosphate groups from the triose phosphates are added to ADP to produce a small yield of ATP.
- Overall, 2 molecules of ATP are used and 4 are made during glycolysis of one glucose molecule, making a net gain of 2 ATPs per glucose. The pyruvic acid is then converted to either lactic acid or alcohol and carbon dioxide without the production of any more ATP.

The pyruvate formed in glycolysis is still energy-rich. It passes next to the **link reaction**. This reaction and all subsequent stages of respiration occur inside a mitochondrion, and can only occur in the presence of free oxygen. Respiration requiring free oxygen is aerobic respiration. Pyruvate is transported into the mitochondrial matrix by a membrane transport protein, which exchanges it for OH<sup>-</sup> in the matrix.

If the cell cannot catabolize the pyruvate molecules further, it will harvest only 2 ATP molecules from 1 molecule of glucose. For example, mature mammalian red blood cells are only capable of glycolysis, which is their sole source of ATP. If glycolysis is interrupted, these cells would eventually die.

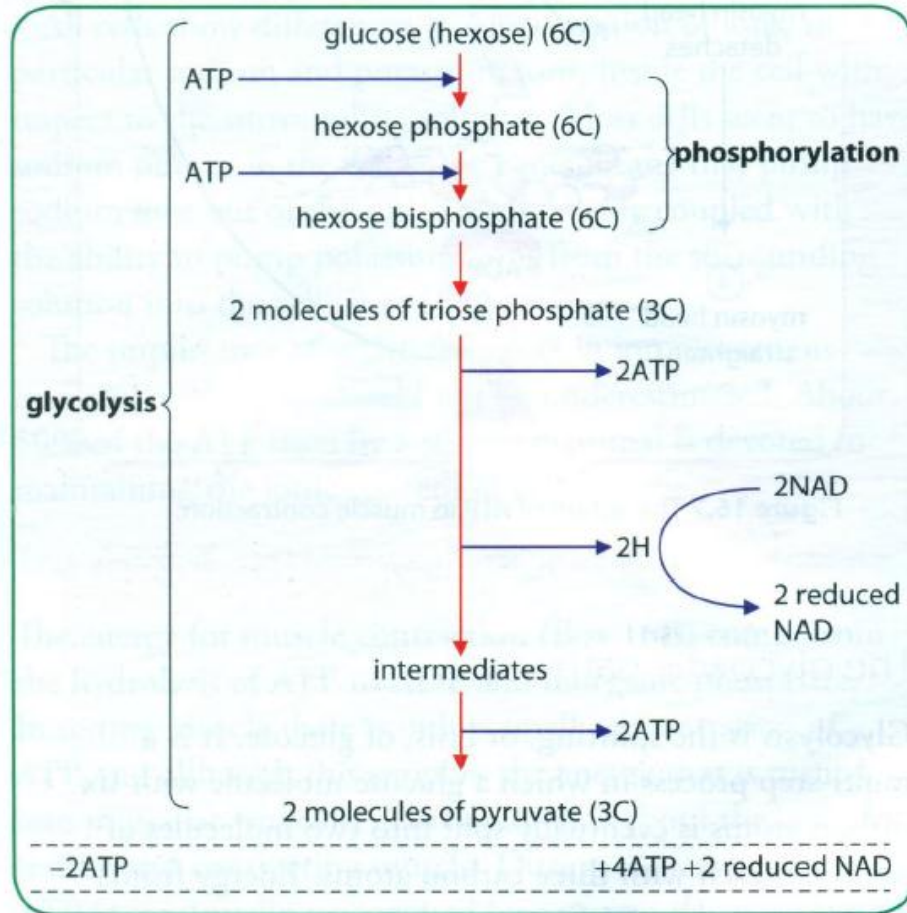

The glycolytic pathway.

## Coenzymes

Respiration involves coenzymes called NAD and FAD. A coenzyme is a molecule required for an enzyme to be able to catalyse a reaction. Hydrogens removed during glycolysis are transferred to the hydrogen carrier molecule **nicotinamide adenine dinucleotide (NAD)** to give **reduced** NAD. The term 'reduce' means to add hydrogen, so reduced NAD has had hydrogen added to it. NAD is present in cells in small quantities and is continually recycled.

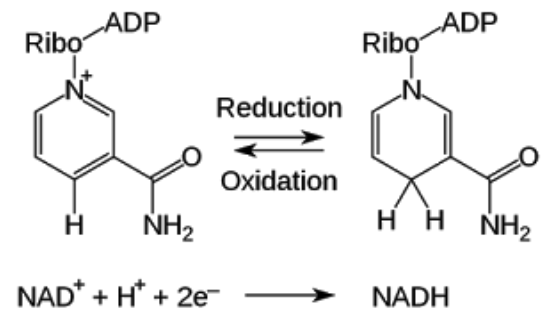

### Glycolysis

- Starting point :  
1 molecule of glucose
- Products :  
2 molecules of pyruvate,  
a net gain of 2 molecules of ATP,  
2 molecules of reduced NAD.

## #72 Aerobic respiration, Link reaction

If oxygen is available, each pyruvate now moves into a mitochondrion, where the **link reaction** and the **Krebs cycle** take place. During these processes, the glucose is completely oxidised.

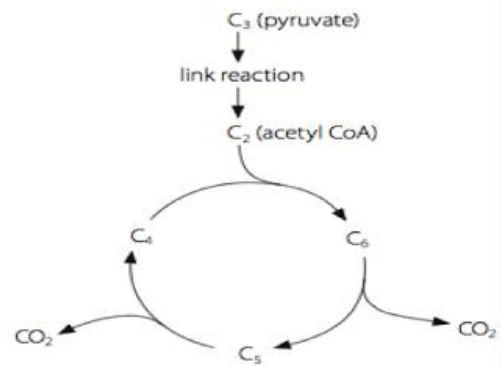

### The link reaction

In the link reaction, pyruvate enters the matrix of a mitochondrion and is:

- **decarboxylated:** **CO<sub>2</sub>** is removed from the pyruvate and then diffuses out of the mitochondrion and out of the cell.
- **dehydrogenated:** **Hydrogen** is removed from the pyruvate, and is picked up by **NAD**, producing reduced NAD. This converts pyruvate into a **2-carbon** compound.
- **combined** with **coenzyme A** to give **acetylcoenzyme A** (ACoA).

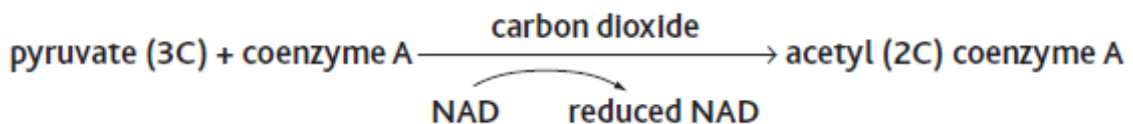
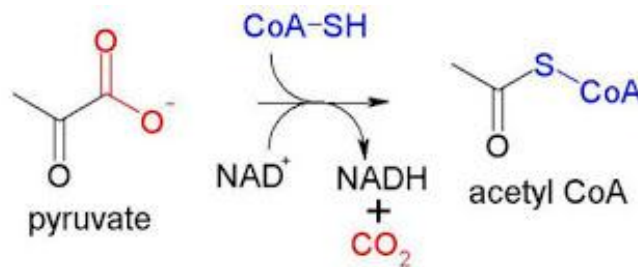

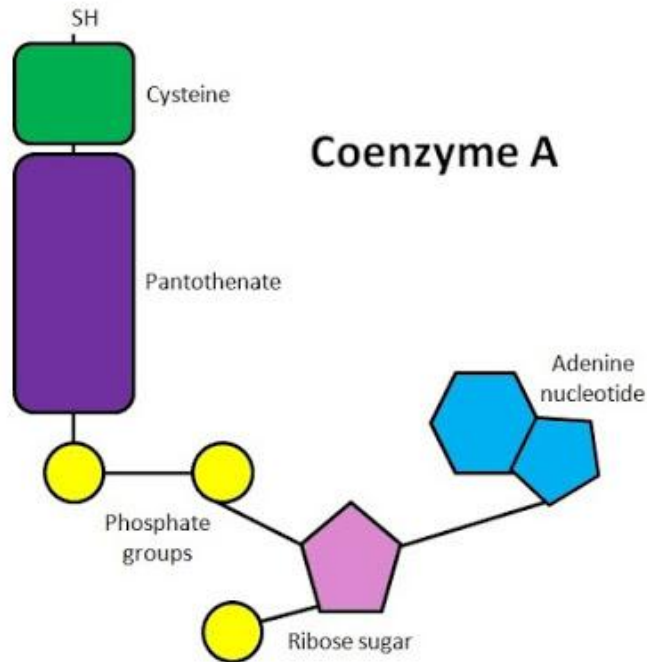

**Coenzyme A** consists of:

- **adenine**
- **ribose** (making a nucleoside together with adenine)
- **pantothenic acid** (a B vitamin).

Coenzyme A transfers an acetyl group (with 2 carbon atoms) from pyruvate into the Krebs cycle and plays a central role in respiration. It is present in small quantities in a cell and is recycled.

### Link reaction

- This reaction transports the Pyruvate made in the cytoplasm into the mitochondria, forming Acetyl-CoA.
- The Acetyl-CoA will then go into the Krebs cycle, which takes place in the mitochondria.
- Since there were 2 pyruvates formed in glycolysis, 2 Acetyl CoA's are formed in total

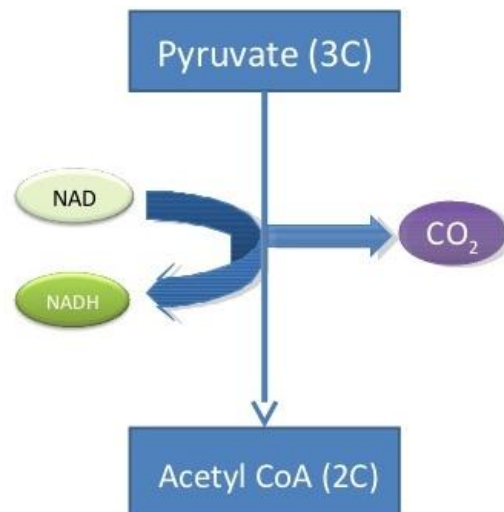

## #73 The Krebs cycle

The **Krebs cycle** occurs in the matrix of the mitochondrion and is the aerobic phase and requires oxygen.

This is also known as the **citric acid cycle** or the **tricarboxylic acid cycle**.

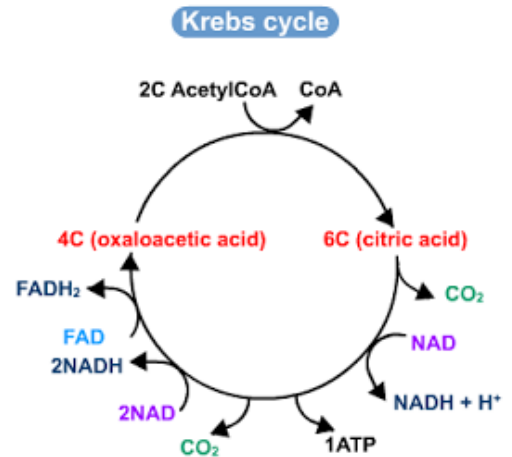

The Krebs cycle is a series of steps catalysed by enzymes in the matrix:

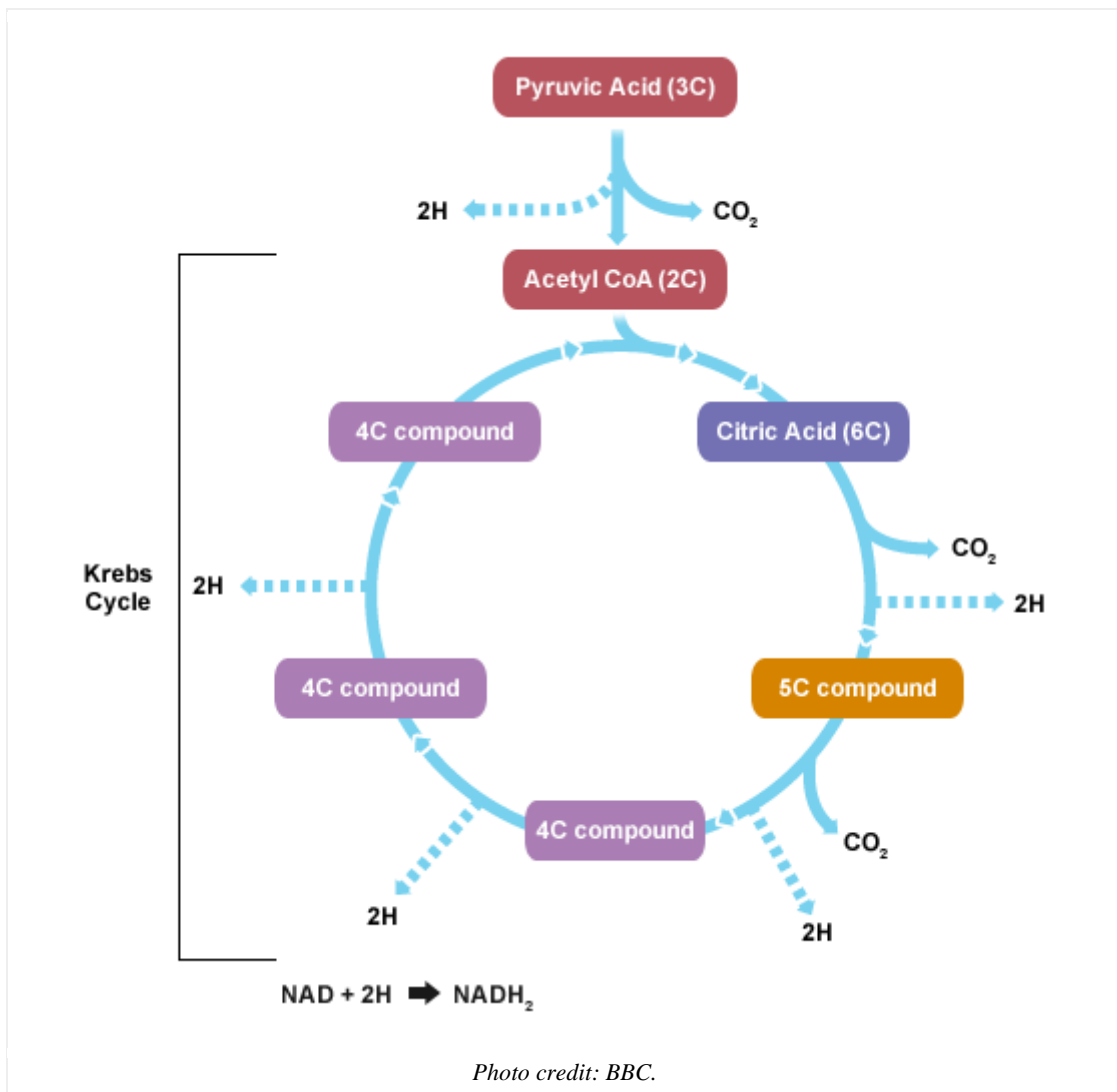

- A **2-carbon** atoms **Acetyl CoA** enters the cycle and combines with a **4-carbon** compound (**oxaloacetate**) to give a **6-carbon** compound (**citrate/citric acid**). Coenzyme A is reformed. Cycle turns twice for each original glucose molecule.
- The **citrate** is then gradually converted back to the **4-carbon oxaloacetate** again in a series of small enzyme-controlled steps involving **decarboxylation** and **dehydrogenation**. 2 C atoms are released in 2 CO<sub>2</sub> molecules and 4 pairs of H atoms are removed.
- The **CO<sub>2</sub>** removed is given off as a waste product. It diffuses out of the mitochondrion and out of the cell.
- The **hydrogens** removed are picked up by **NAD** and another coenzyme called **FAD** (flavin adenine dinucleotide). 1 FAD and 3 NAD molecules are reduced during each turn of the cycle. H in reduced NAD/FAD will be released in oxidative phosphorylation. The main role of the Krebs cycle in respiration is to generate a pool of reduced **hydrogen carriers** to pass on to the next stage.
- The regenerated **oxaloacetate** can combine with another ACoA.
- 1 ATP is produced directly by **substrate-level phosphorylation** for each ACoA entering the cycle.
- Amino acids and fatty acids can be broken down and fed into cycle.

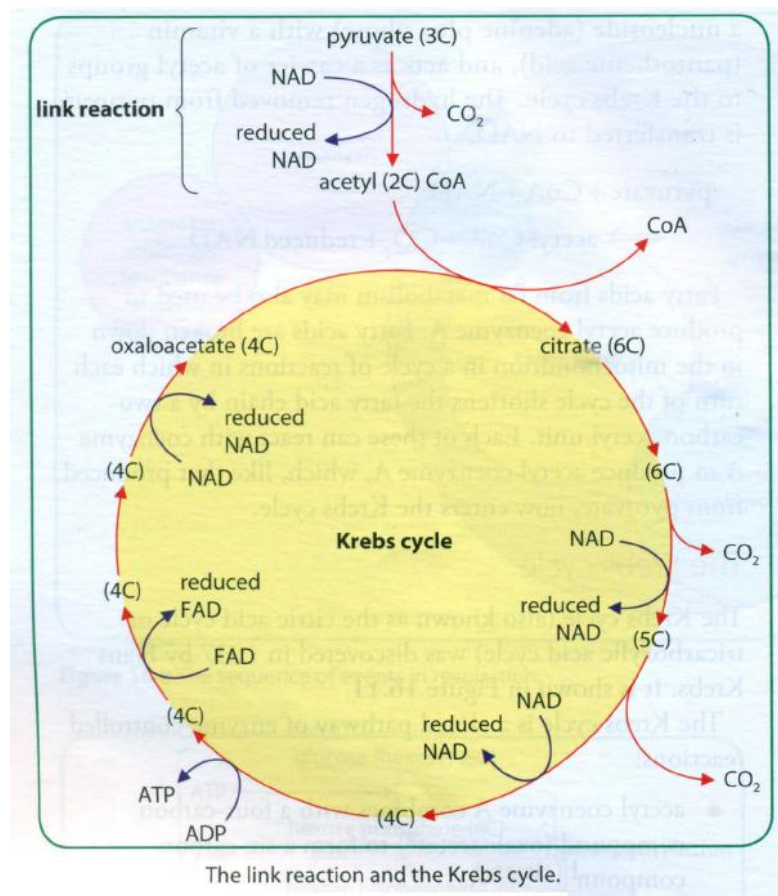

## # 74 Oxidative phosphorylation and Electron transport chain

In the final stage of aerobic respiration, **oxidative phosphorylation**, the energy for the phosphorylation of ADP to ATP comes from the activity of the **electron transport chain (ETC)**. Oxidative phosphorylation takes place in the inner mitochondrial membrane, the cristae.

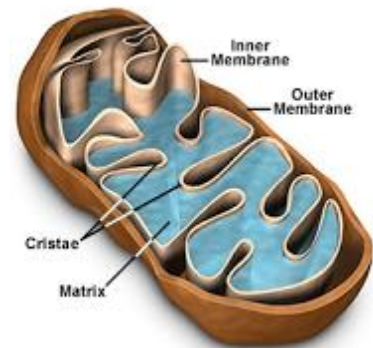

Hydrogens from reduced FAD and reduced NAD first pass to hydrogen carriers in the inner membrane and are then split into **protons** ( $H^+$ ) and **electrons** ( $e^-$ ).

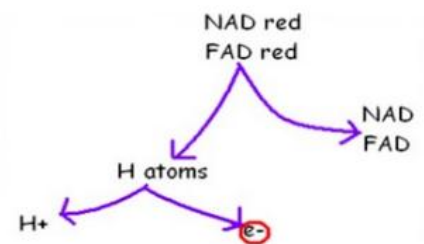

The **electrons** pass along a series of electron carriers on the **ETC** of the inner membrane of the mitochondrion. Each of these electron carriers is at a lower energy level than its predecessor. As the electrons move along the chain, they lose energy. This energy is used to actively transport  **$H^+$**  from the matrix of the mitochondrion, across the inner membrane and into the space between the inner and outer membranes. This builds up a high concentration of  $H^+$  in this space.

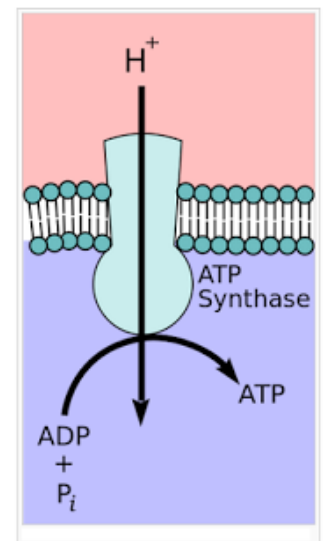
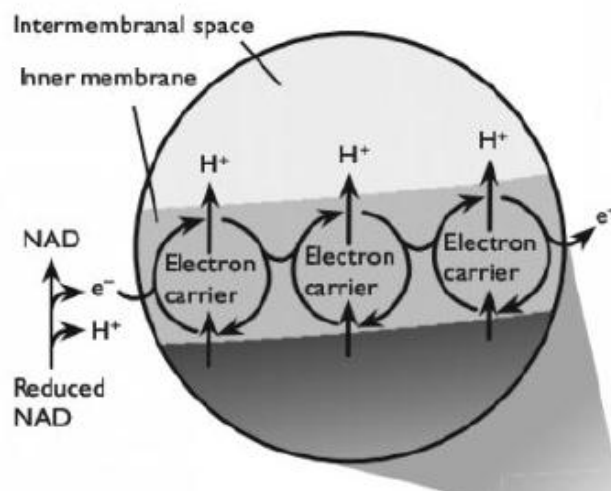

The  **$H^+$**  are allowed to diffuse back into the matrix through special channel proteins that work as **ATPases**. The movement of the  $H^+$  through the ATPases provides enough

energy to cause ADP and inorganic phosphate to combine to make **ATP**. At the end of the chain, the **electrons** reunite with the **protons** from which they were originally split. They combine with **oxygen** to produce **water**. This is why oxygen is required in aerobic respiration - it acts as the final acceptor for the hydrogens removed from the respiratory substrate during glycolysis, the link reaction and the Krebs cycle.



Summary of the oxidative phosphorylation:

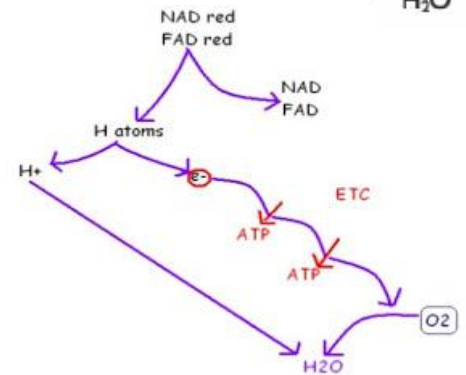

### Oxidative phosphorylation

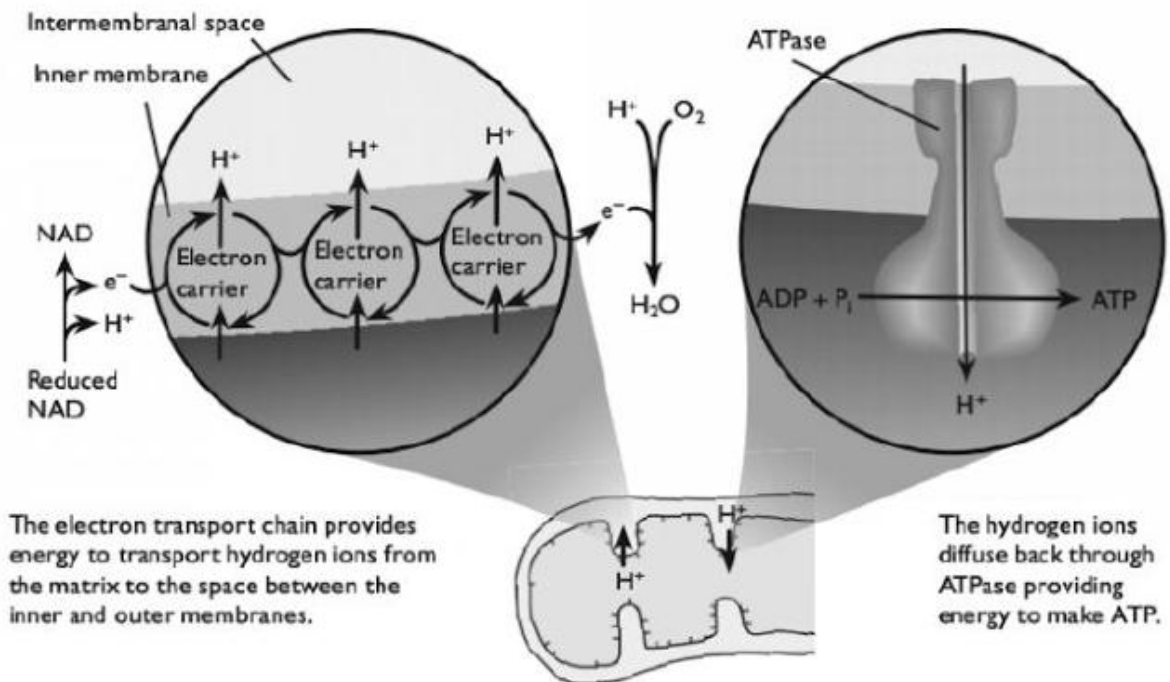

	ATP used	ATP made	Net gain in ATP
glycolysis	-2	4	+2
link reaction	0	0	0
Krebs cycle	0	2	+2
oxidative phosphorylation	0	28	+28
Total	-2	34	+32

Balance sheet of ATP use and synthesis for each molecule of glucose entering respiration.



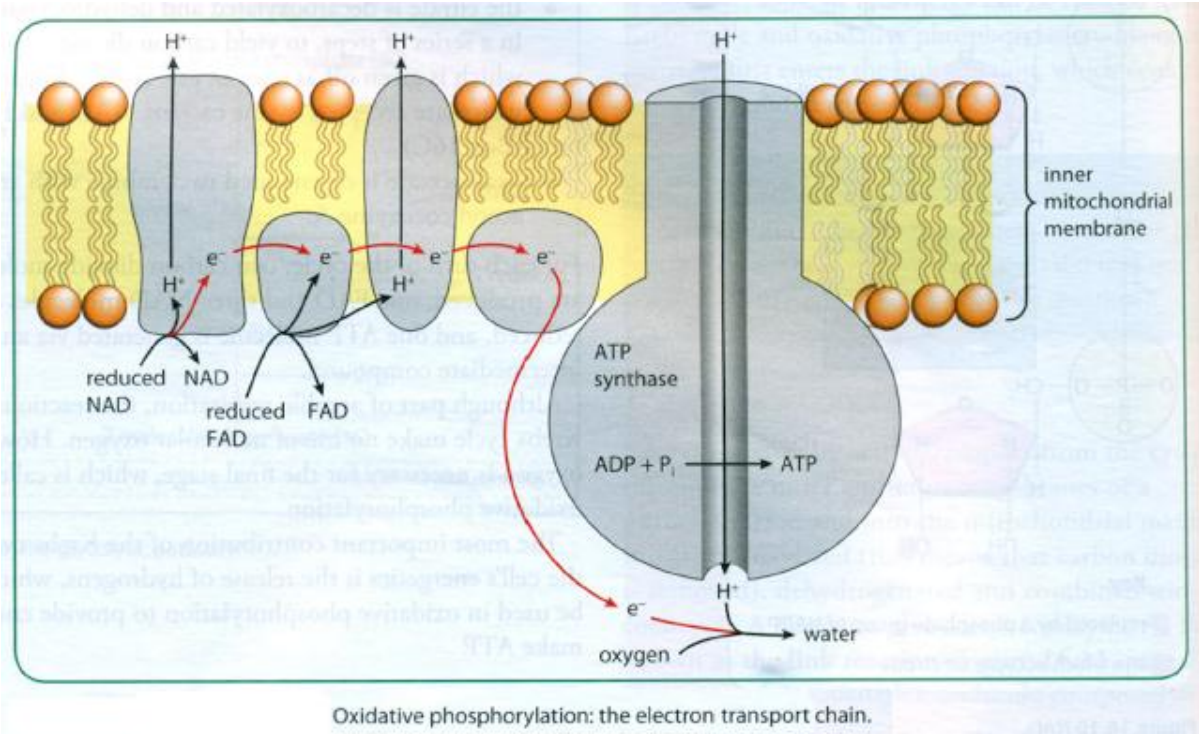

### The sequence of events in the respiration

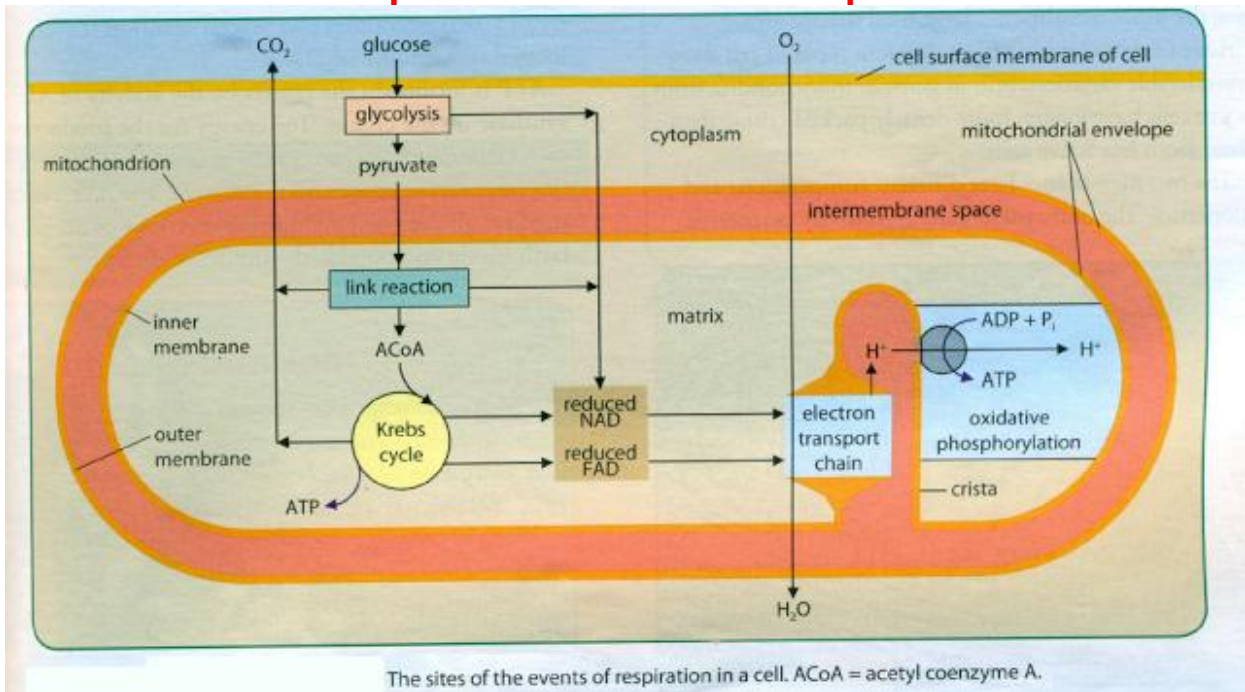

### Video: Oxidative phosphorylation and Electron transport chain

<https://www.youtube.com/watch?v=KGjCm566-MY>

<https://www.youtube.com/watch?v=IRITBRPv6xM>

<https://www.youtube.com/watch?v=6W-7FG9KlpA>

## # 75 Anaerobic respiration - Ethanol and Lactate pathways

**Anaerobic respiration** is a type of respiration that does not use oxygen. It is used when there is not enough oxygen for aerobic respiration.

In the absence of free oxygen:

- Oxidative phosphorylation cannot take place, as there is nothing to accept the electrons and protons at the end of the electron transport chain.
- Hydrogen cannot be used up by combining it with oxygen to give water, so reduced NAD cannot be recycled to NAD in this way to allow glycolysis to continue.
- The mitochondrion quickly runs out of NAD or FAD that can accept hydrogens from the Krebs cycle reactions. The Krebs cycle and the link reaction therefore come to a halt.
- **Glycolysis**, however, can still continue, so long as the pyruvate produced at the end of it can be removed and the reduced NAD can be converted back to NAD.



Two other pathways allow the recycling of reduced NAD formed during glycolysis:

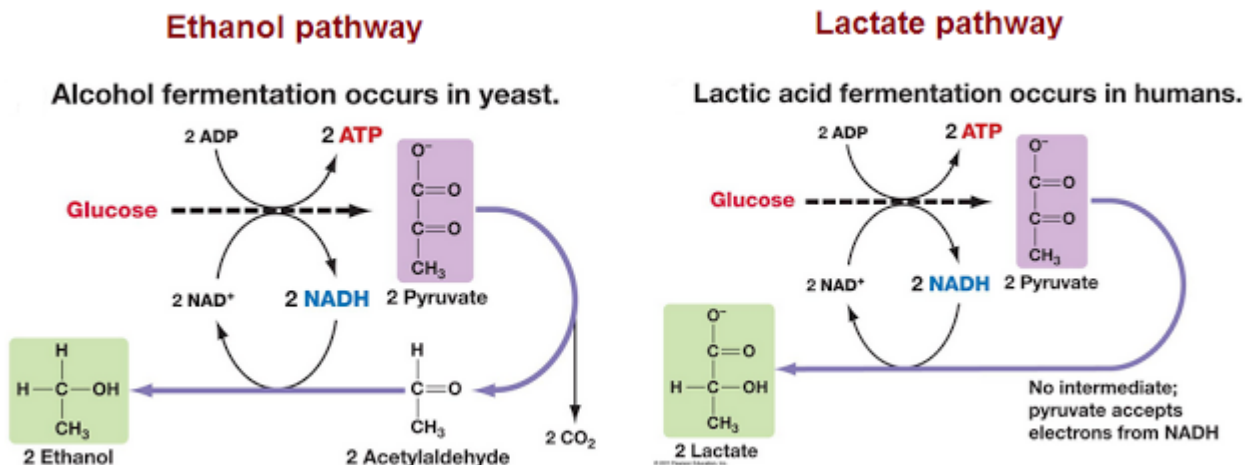

- **Ethanol** pathway: conversion of **pyruvate** to **ethanol** in alcoholic fermentation, e.g. by yeast

- **Lactate** pathway: conversion of **pyruvate** to **lactate** (lactic acid), e.g. by mammalian muscle.

### 1. The ethanol pathway

In yeast and in plants, the pyruvate is removed by converting it to ethanol.

- **Pyruvate** is decarboxylated to **acetaldehyde/ethanal** (CH<sub>3</sub>CHO).

- This accepts hydrogen from reduced NAD and is reduced to **ethanol** (C<sub>2</sub>H<sub>5</sub>OH), releasing NAD.

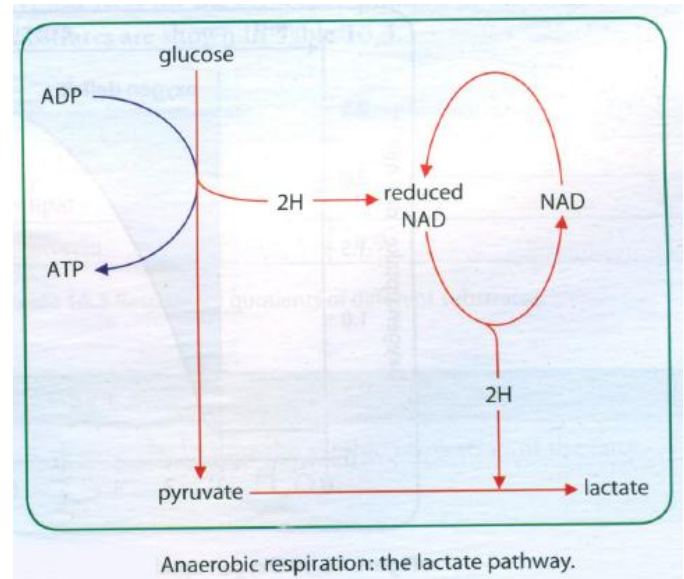
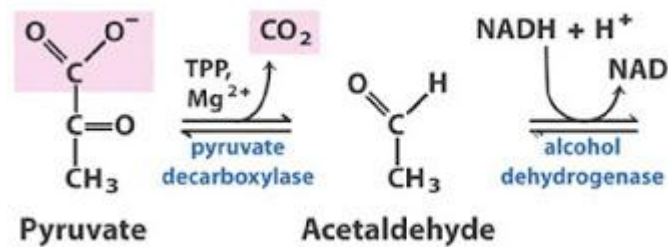
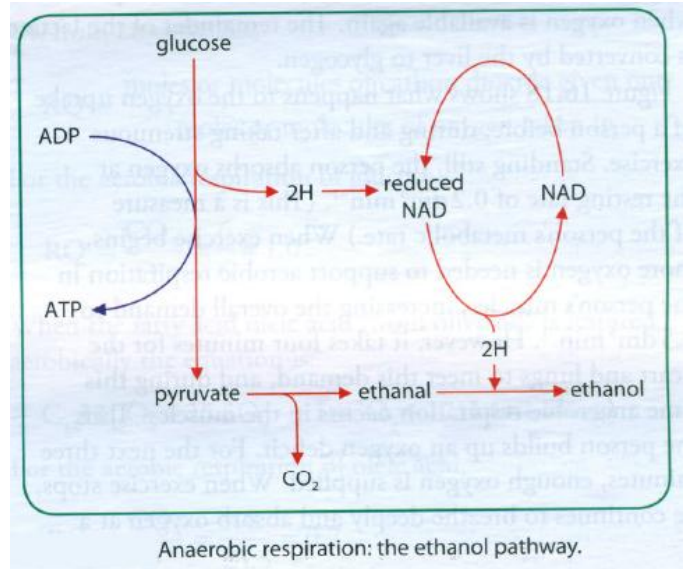

### 2. The lactate pathway

In mammalian muscles that are deprived of oxygen, pyruvate itself acts as the hydrogen acceptor and is removed by converting it to lactate. Again, NAD is released.

#### The Cori cycle

In mammals, lactate produced during strenuous muscle activity is taken up from blood plasma by the liver, where it is converted to pyruvate and thence to glucose or glycogen.

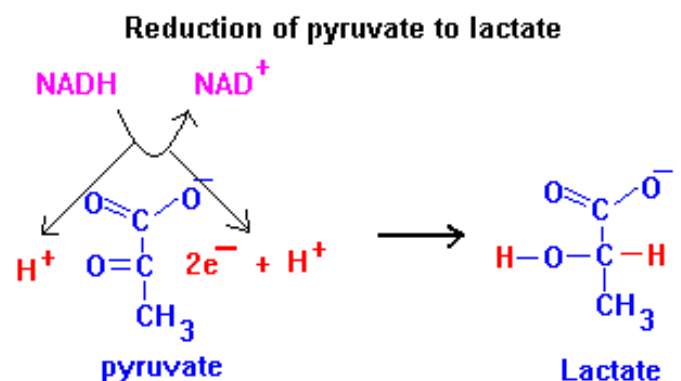

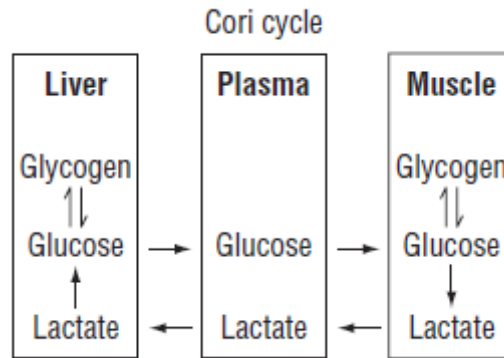

The Cori cycle serves two purposes:

- it 'rescues' lactate and prevents the wasteful loss of some of its chemical bond energy
- it prevents a potentially disastrous fall in plasma pH.

The lactate that is produced in muscles diffuses into the blood and is carried in solution in the blood plasma to the liver. Here, liver cells convert it back to pyruvate. This requires oxygen, so extra oxygen is required after exercise has finished. The extra oxygen is known as the **oxygen debt**.

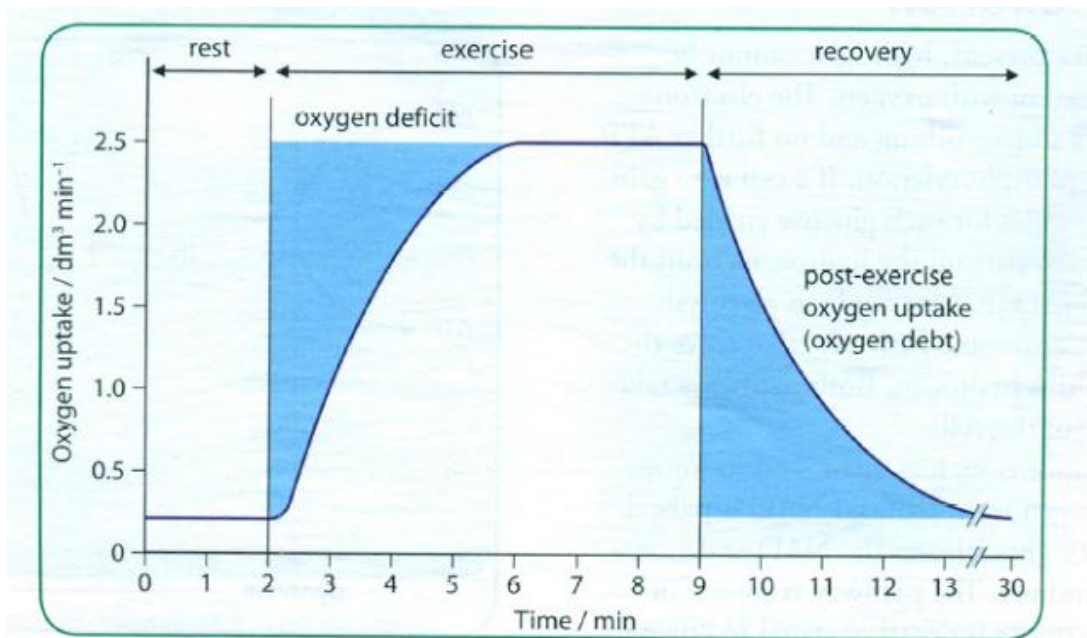

Oxygen uptake before, during and after strenuous exercise.

Later, when the exercise has finished and oxygen is available again, some of the pyruvate in the liver cells is oxidised through the link reaction, the Krebs cycle and the electron transport chain. Some of the pyruvate is reconverted to glucose

in the liver cells. The glucose may be released into the blood or converted to glycogen and stored.

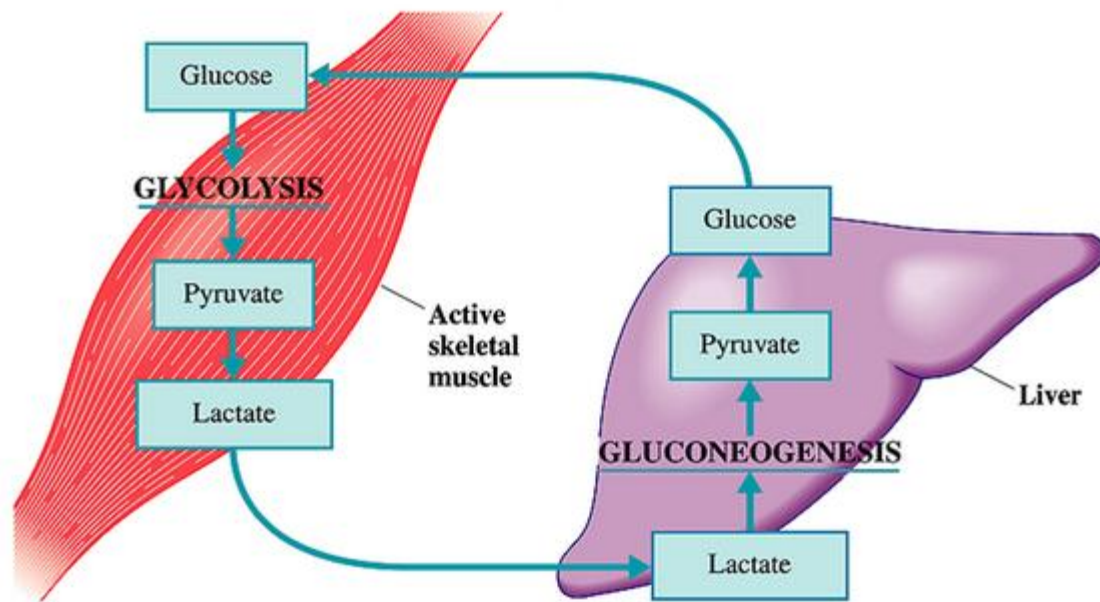

Note:

- Both reactions 'buy time' by providing hydrogen acceptors so that NAD is released and glycolysis can continue.
- Both pathways are inefficient and wasteful in that the products (ethanol or lactate) have chemical bond energy that is untapped.
- The ethanol or lactate produced is toxic and restricts the use of the pathways.
- While the lactate pathway is reversible (by the Cori cycle) in the mammalian liver, the ethanol pathway is irreversible.
- There is a net gain of only two ATP molecules per glucose molecule (from glycolysis) during anaerobic respiration.

## #76 ATP yield in aerobic and anaerobic respiration

Only small amounts of ATP are produced when one glucose molecule undergoes **anaerobic respiration**. This is because only glycolysis is completed. The Krebs cycle and oxidative phosphorylation, which produce most ATP do not take place.

The precise number of molecules of ATP produced in **aerobic respiration** of one glucose molecule varies between different organisms and different cells, but is usually between 30 and 32 molecules.

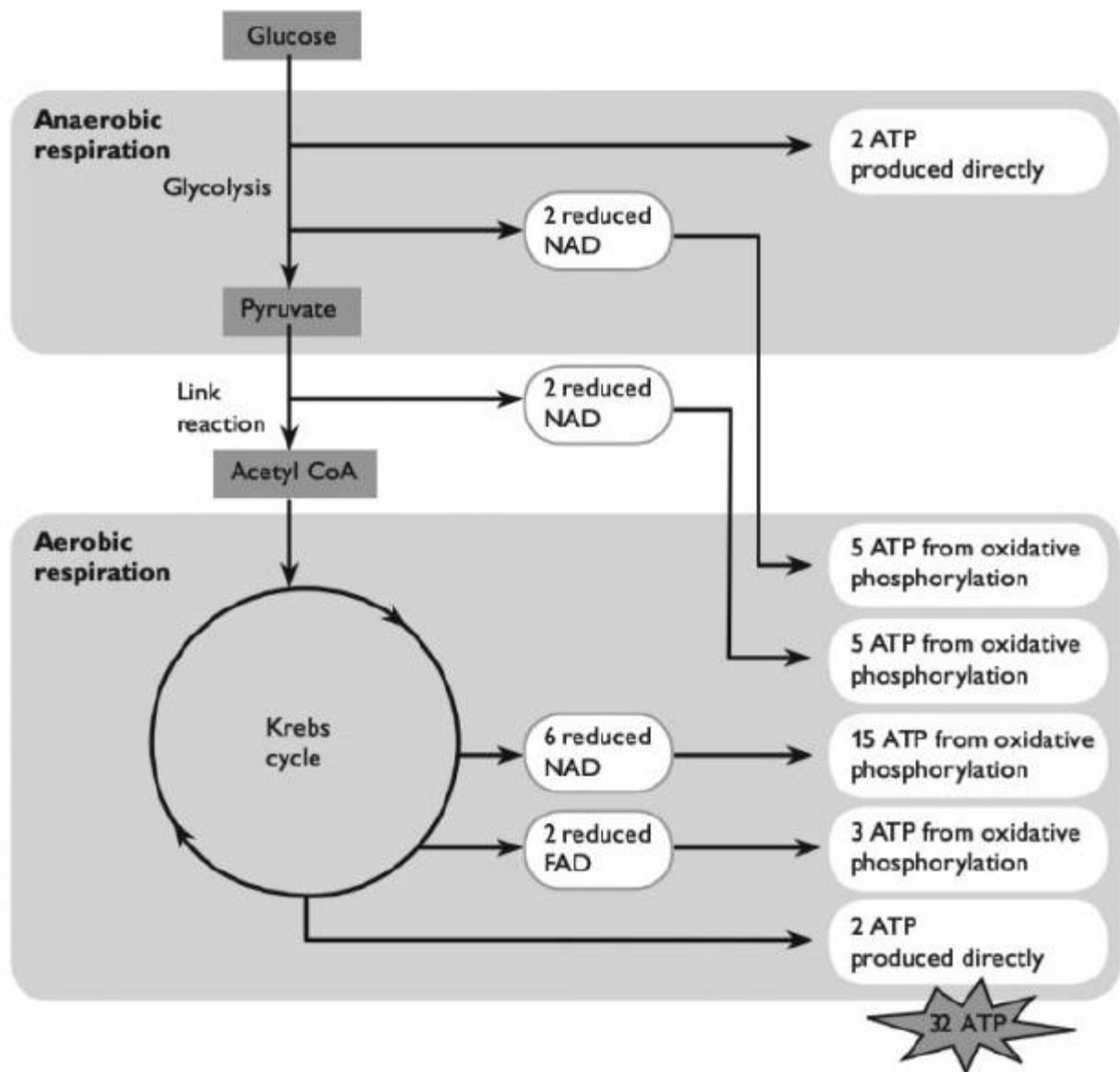
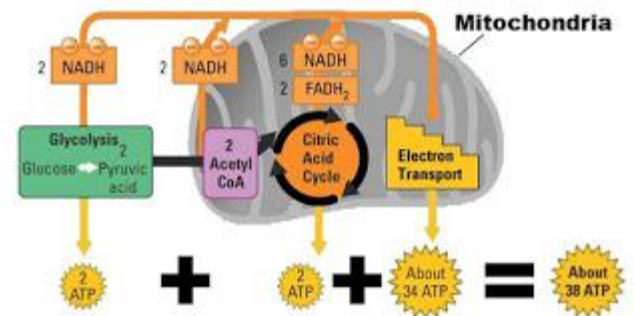

*ATP yields in each step of respiration*

## #77 Respiratory substrates, Respiratory quotients

A respiratory substrate is a molecule from which energy can be liberated to produce ATP in a living cell. Glucose is not the only respiratory substrate. All carbohydrates, lipids and proteins can also be used as respiratory substrates.



Many cells in the human body are able to use a range of different respiratory substrates. However, brain cells can only use glucose. Heart muscle preferentially uses fatty acids.

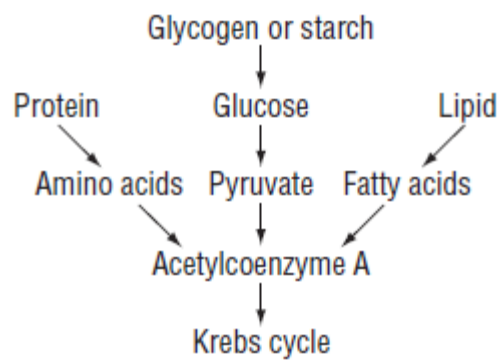

- **Glucose** is an essential fuel for some cells, e.g. brain cells, red blood cells and lymphocytes, but some cells, e.g. liver cells, also oxidise lipids and excess amino acids.
- The **fatty acid** components of lipids are important: carbon atoms are detached in pairs as ACoA and fed into the Krebs cycle.
- **Amino acids** are deaminated and their carbon–hydrogen skeletons converted into pyruvate or into ACoA.

The energy values of these different substrates are not the same.

### Energy values of respiratory substrates

Most of the energy released in respiration comes from the oxidation of hydrogen to water. The more hydrogens there are (in comparison with carbon or oxygen atoms) in the structure of a molecule, the greater the energy value. It is hydrogen atoms that are used to generate ATP via the electron transport chain.

Fatty acids have more hydrogens per unit mass than carbohydrates, so lipids have a greater energy value per unit mass (lipid provides more than twice as much energy per gram as carbohydrate or protein). Energy values in kJ g<sup>-1</sup> are determined by burning a known mass of the substance in oxygen in a bomb calorimeter. Typical energy values are:

Respiratory substrate	Energy value/kJ g <sup>-1</sup>
Carbohydrate	16
Lipid	39
Protein	17

### Respiratory quotients

It is possible to get a good idea of which respiratory substrate the cells in an organism are using by measuring the volume of oxygen it is taking in and the volume of carbon dioxide it is giving out.

$$RQ = \frac{V_{CO_2}}{V_{O_2}}$$

#### *RQs for different substrates undergoing aerobic respiration*

Respiratory substrate	RQ
Carbohydrate	1.0
Lipid	0.7
Protein	0.9

The values in the table are for aerobic respiration. If a cell or an organism is respiring anaerobically, then no oxygen is being used. The RQ is therefore infinity (∞).



## #78 Structure and function of the mitochondrion

The mitochondrion is a power plant and industrial park of the cell where energy stored in the bonds of carbohydrates is converted to a form more useful to the cell (ATP) and certain essential biochemical conversions of amino acids and fatty acids occur.

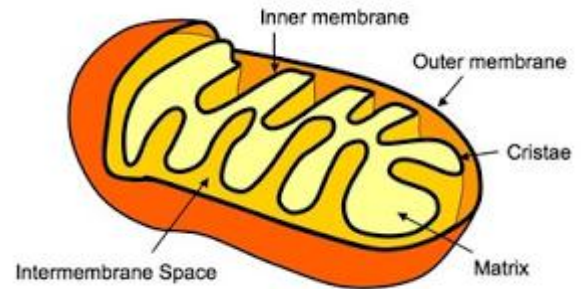

### Structure

Mitochondria is about 1 μm in diameter and 1-10 μm in length. Mitochondria have dynamic structures that move, change their shape and divide.

- Enclosed by two membranes that have proteins embedded in phospholipid bilayers
- Outer membrane is smooth and highly permeable to small solutes, but it blocks passage of proteins and other macromolecules
- Inner membrane is convoluted and contains embedded enzymes that are involved in cellular respiration. The membrane has many infoldings called cristae which increase the surface area available for these reactions to occur.
- The inner and outer membranes of mitochondria divide it into two internal compartments: intermembrane space is the narrow region between the inner and outer mitochondrial membranes.
- It resembles the solute composition of the cytosol, because the outer membrane is permeable to small solute molecules.
- Mitochondrial matrix is the compartment enclosed by the inner mitochondrial membrane
- It contains enzymes that catalyze many metabolic steps of cellular respiration
- Some respiratory enzymes are embedded in the inner membrane.

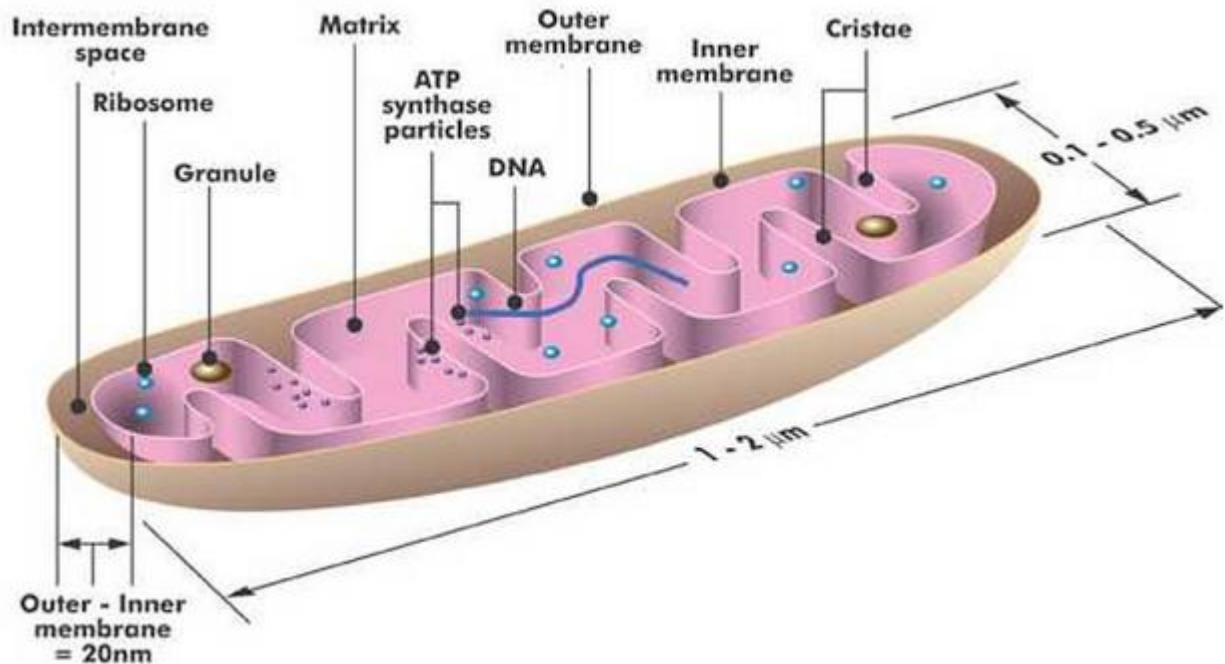

### Functions of Mitochondria

- The major function of the mitochondria is to produce energy. The energy giving food molecule are sent to the mitochondrion where they are further precessed to produce charged molecules that combine with oxygen and produce ATP molecules. This total process is known as oxidative phosphorylation.
- NADH and FADH<sub>2</sub> from glycolysis, pyruvate oxidation, and the citric acid cycle are oxidized by the respiratory chain, regenerating NAD<sup>+</sup> and FAD. Most of the enzymes and other electron carriers of the chain are part of the inner mitochondrial membrane. Oxygen (O<sub>2</sub>) is the final acceptor of electrons and protons, forming water (H<sub>2</sub>O).
- A Chemiosmotic Mechanism Produces ATP As electrons pass through the series of protein complexes in the respiratory chain, protons are pumped from the mitochondrial matrix into the intermembrane space. As the protons return to the matrix through ATP synthase, ATP is formed.

Source: [Tutor Vista](#).

## #79 Rice adaptation for growing with its roots submerged in water

There are many varieties of rice and they differ in their water requirements. Most of the rice in south-east Asia is grown in unusual conditions for a cereal plant. It is grown partly submerged in water in paddy fields.



The fields are flooded and then ploughed. Young rice plants are planted in the rich mud formed in these paddy fields. The oxygen concentration of this mud fails rapidly after the paddy field has been flooded. The top ten centimetres or so retains some oxygen because it is able to diffuse in but below this depth anaerobic conditions exist and there is little or no oxygen present.

Rice plants have a number of adaptations which enable them to grow well in these conditions.

Rice **stems** contain a large number of air spaces (hollow **aerenchyma**) running the length of the stem and into the roots. This allows oxygen (some formed in the plant from photosynthesis) to penetrate through to the roots which are submerged in water, supplying oxygen for aerobic respiration. This decreases the chance that anaerobic respiration will occur.

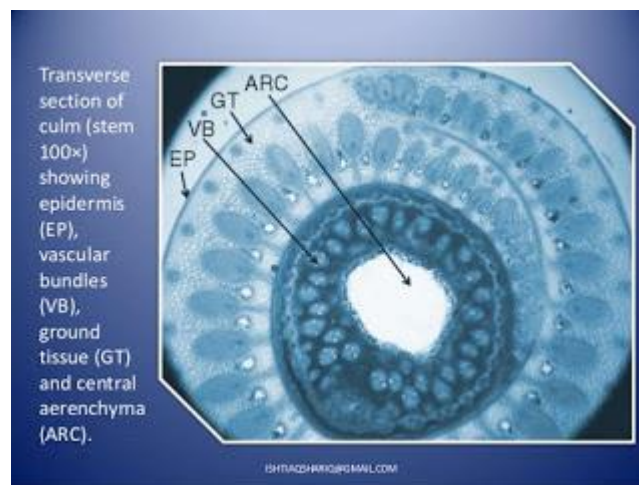

*ARC - Central aerenchyma in the rice stem.*

Many of rice **roots** are very **shallow**, allowing access to oxygen that diffuses into the surface layer of the waterlogged soil.

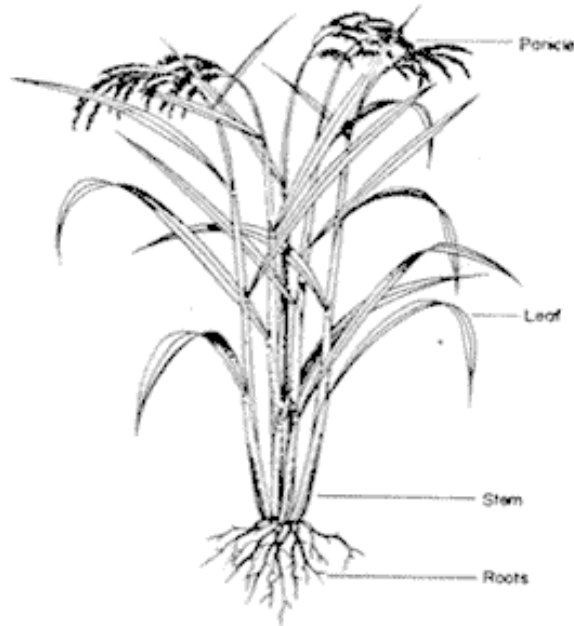

When fields in which a cereal such as wheat is growing are flooded for any length of time, the plants die. The oxygen concentration of the waterlogged soil falls rapidly. The root cells are unable to get the oxygen they need in order to respire. In these conditions they can carry on respiring without oxygen. This is called **anaerobic respiration** and results in **ethanol** being formed as a waste product. Unfortunately, this substance is poisonous so a plant can only respire in this way for a short time before the ethanol concentration builds up and kills it.

**Cells in the roots** of rice plants have been shown to be **extremely tolerant of ethanol**, much more so than cells from the roots of other cereals. They can therefore respire anaerobically for longer periods. When oxygen levels fall too low, the young rice plants can respire anaerobically, producing ethanol. Ethanol is normally toxic to cells, but the root cells of rice have an unusually high tolerance to it – they have a high concentration of the enzyme alcohol dehydrogenase in their cells. Adult plant roots are as intolerant of flooding as any other crop.

There are two advantages of growing rice in paddy fields. Flooding brings about chemical changes in the soil which increases the supply of soil nutrients required by the rice plants. It also reduces weeds. Rice does not grow well when it has to compete with weeds for the resources that it needs.

Source: [Cix.co.uk](http://Cix.co.uk)

## #80 Using respirometers

A **respirometer** is a device used to measure the rate of respiration of a living organism by measuring its rate of exchange of **oxygen** and/or **carbon dioxide**. They allow investigation into how factors such as age, chemicals or the effect of light affect the rate of respiration.

There are various different types of respirometer. One type is shown in the diagram.

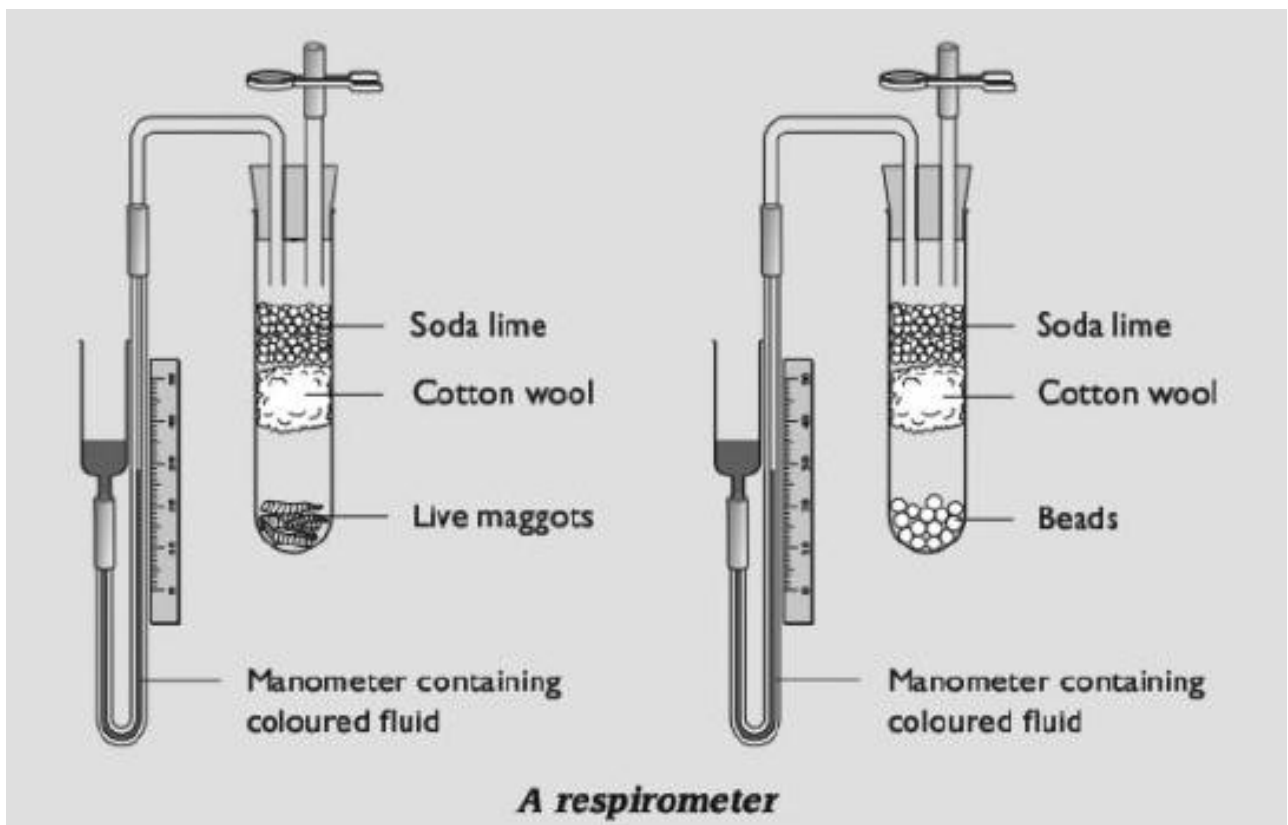
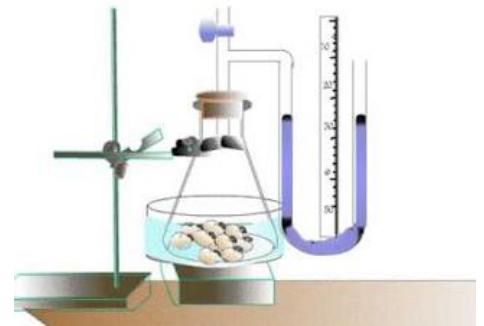

### Using a respirometer to measure the rate of uptake of oxygen

The organisms to be investigated are placed in one tube, and non-living material of the same mass in the other tube. Soda lime is placed in each tube, to absorb all carbon dioxide. Cotton wool prevents contact of the soda lime with the organisms.

Coloured fluid is poured into the reservoir of each manometer and allowed to flow into the capillary tube. It is essential that there are no air bubbles. You must end up with exactly the same quantity of fluid in the two manometers.

Two rubber bungs are now taken, fitted with tubes as shown in the diagram. Close the spring clips. Attach the manometers to the bent glasstubing, ensuring an airtight connection. Next, place the bungs into the tops of the tubes.

Open the spring clips. (This allows the pressure throughout the apparatus to equilibrate with atmospheric pressure.) Note the level of the manometer fluid in each tube. Close the clips. Each minute, record the level of the fluid in each tube.

As the organisms respire, they take oxygen from the air around them and give out carbon dioxide. The removal of oxygen from the air inside the tube reduces the volume and pressure, causing the manometer fluid to move towards the organisms. The carbon dioxide given out is absorbed by the soda lime. The distance moved by the fluid is therefore affected only by the oxygen taken up and not by the carbon dioxide given out.

You would not expect the manometer fluid in the tube with no organisms to move, but it may do so because of temperature changes. This allows you to control for this variable, by subtracting the distance moved by the fluid in the control manometer from the distance moved in the experimental manometer (connected to the Living organisms), to give you an adjusted distance moved.

Calculate the mean (adjusted) distance moved by the manometer fluid per minute. If you know the diameter of the capillary tube, you can convert the distance moved to a volume:

$$\text{volume of liquid in a tube} = \text{length} \times \pi r^2$$

This gives you a value for the volume of oxygen absorbed by the organisms per minute.

### **Using a respirometer to investigate the effect of temperature on the rate of respiration**

The respirometer can be placed in water baths at different temperatures. You can use the same respirometer for the whole experiment. Or you could have different ones for each temperature. (In each case, there are difficulties with controlling some variables - you might like to think about what these are.) At each temperature, you need a control respirometer with no organisms in it.

If you are simply **comparing** the rates of respiration at different temperatures, then you do not need to convert the distance moved by the manometer fluid to a volume. You could just plot distance moved on the y-axis of your graph and time on the x-axis.

The rate of respiration is represented by the gradient of the graph.

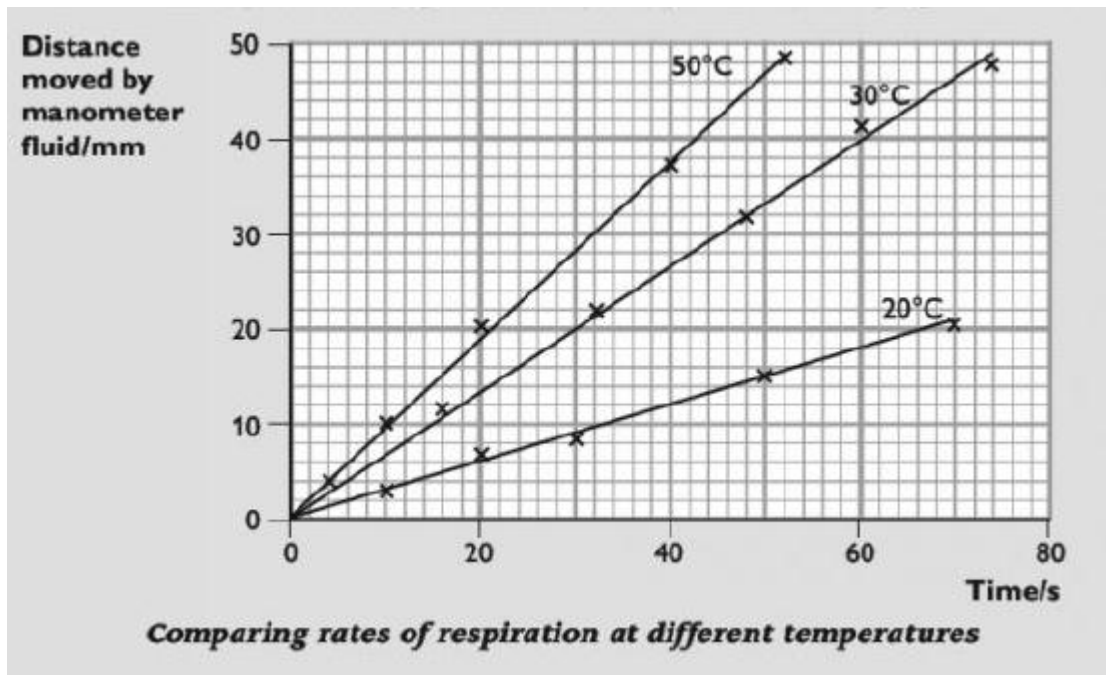

At 50°C manometer fluid travelled 47 mm in 50 s

$$\text{Rate of respiration} = \frac{47}{50} = 0.94 \text{ mm s}^{-1}$$

At 30°C manometer fluid travelled 40 mm in 60 s

$$\text{Rate of respiration} = \frac{40}{60} = 0.67 \text{ mm s}^{-1}$$

At 20°C manometer fluid travelled 21 mm in 70 s

$$\text{Rate of respiration} = \frac{24}{70} = 0.34 \text{ mm s}^{-1}$$

### Using a respirometer to measure RQ

For this, we need to know both how much oxygen is taken in, and how much carbon dioxide is given out.

Set up two respirometers as shown above. However, the second respirometer should also contain the same mass of live maggots (or whatever organism you are investigating) but should **not** contain soda lime. You could put some inert material into the tube (for example, the beads) instead of soda lime. The mass and volume of the inert material should be the same as the mass and volume of the soda lime.

This second tube is therefore just like the first one except that it does not contain soda lime. The carbon dioxide given out by the respiring organisms is therefore not absorbed.

The difference between the distance moved by the manometer fluid in the

experimental tube and the distance moved in the control tube is therefore due to the carbon dioxide given out.

distance moved by fluid in experimental tube =  $x$ mm

distance moved by fluid in control tube =  $y$ mm

$x$ mm represents the oxygen taken up

$x - y$  represents the carbon dioxide given out

therefore  $RQ = \frac{x - y}{x}$

For example, if the respiratory substrate is carbohydrate, then the amount of carbon dioxide given out will equal the amount of oxygen taken in. The fluid in the control tube will not move, so  $y=0$ .

RQ is then  $\frac{x}{x} = 1$

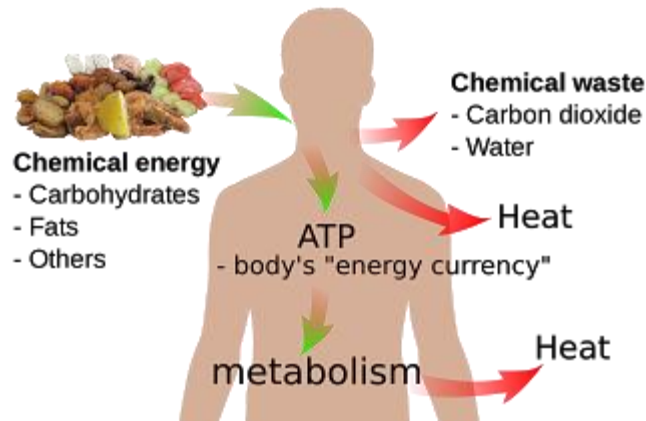

## #81 Summary of Energy and Respiration

**Energy and human life**

1 Organisms must do work to stay alive. The energy input necessary for this work is either light, for photosynthesis, or the chemical potential energy of organic molecules. Work includes anabolic reactions, active transport and movement. Some organisms, such as mammals and birds, use thermal energy released from metabolic reactions to maintain their body temperature.

2 Reactions that release energy must be harnessed to energy-requiring reactions. This 'harnessing' involves an intermediary molecule, ATP. This can be synthesised from ADP and phosphate using energy, and hydrolysed to ADP and phosphate to release energy. ATP therefore acts as an energy currency in all living organisms.

3 Respiration is the sequence of enzyme-controlled steps by which an organic molecule, usually glucose, is broken down so that its chemical potential energy can be used to make the energy currency, ATP.

4 In aerobic respiration, the sequence involves four main stages: glycolysis, the link reaction, the Krebs cycle and oxidative phosphorylation.

5 In glycolysis, glucose is first phosphorylated and then split into two triose phosphate molecules. These are further oxidised to pyruvate, giving a small yield of ATP and reduced NAD. Glycolysis occurs in the cell cytoplasm.

6 When oxygen is available (aerobic respiration), the pyruvate passes to the matrix of a mitochondrion. There, in the link reaction, pyruvate is decarboxylated and dehydrogenated and the remaining 2C acetyl unit combined with coenzyme A to give acetyl coenzyme A.

7 The acetyl coenzyme A enters the Krebs cycle in the mitochondrial matrix and donates the acetyl unit to oxaloacetate (4C) to make citrate (6C).

8 The Krebs cycle decarboxylates and dehydrogenates citrate to oxaloacetate in a series of small steps. The oxaloacetate can then react with another acetyl coenzyme A from the link reaction.

9 Dehydrogenation provides hydrogen atoms, which are accepted by the carriers NAD and FAD. These pass to the inner membrane of the mitochondrial envelope, where they are split into protons and electrons.

10 In the process of oxidative phosphorylation, the electrons are passed along a series of carriers. Some of the energy released in this process is used to move protons from the mitochondrial matrix to the intermembrane space. This sets up a gradient of protons across the inner membrane of the mitochondrial envelope. The protons pass back into the matrix, moving down their concentration gradient through protein channels in the inner membrane. An enzyme, ATP synthase, is associated with each of these channels. ATP synthase uses the electrical potential energy of the proton gradient to phosphorylate ADP to ATP.

11 At the end of the carrier chain, electrons and protons are recombined and reduce oxygen to water.

12 In the absence of oxygen as a hydrogen acceptor (in anaerobic respiration), a small yield of ATP is made by dumping hydrogen into other pathways in the cytoplasm which produce ethanol or lactate. The lactate pathway can be reversed in mammals when oxygen becomes available. The oxygen needed to remove the lactate produced during anaerobic respiration is called the oxygen debt.

13 The energy values of respiratory substrates depend on the number of hydrogen atoms per molecule. Lipids have a higher energy density than carbohydrates or proteins.

14 The respiratory quotient (RQ) is the ratio of the volumes of oxygen absorbed and carbon dioxide given off in respiration. The RQ reveals the nature of the substrate being respired. Carbohydrate has an RQ of 1.0, lipid 0.7 and protein 0.9.

15 Oxygen uptake, and hence RQ, can be measured using a respirometer.

### 1. End-of-chapter questions

1. What does not occur in the conversion of glucose to two molecules of pyruvate?

- A hydrolysis of ATP
- B phosphorylation of ATP
- C phosphorylation of triose (3C) sugar
- D reduction of NAD

2. Where does each stage of aerobic respiration occur in a eukaryotic cell?

	link reaction	Krebs cycle	oxidative phosphorylation
A	cytoplasm	mitochondrial matrix	mitochondrial cristae
B	mitochondrial cristae	cytoplasm	mitochondrial matrix
C	cytoplasm	mitochondrial cristae	mitochondrial matrix
D	mitochondrial matrix	mitochondrial matrix	mitochondrial cristae

3 The diagram summarises anaerobic respiration.

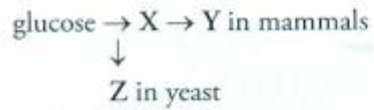

Which compounds are represented by the letters X, Y and Z?

	X	Y	Z
A	ethanol	pyruvate	lactate
B	lactate	ethanol	pyruvate
C	pyruvate	ethanol	lactate
D	pyruvate	lactate	ethanol

4 Distinguish between:

- an **energy currency** molecule and an **energy storage** molecule.
- decarboxylation** and **dehydrogenation**.

5 State the roles in respiration of:

- NAD
- coenzymeA
- oxygen.

6 Copy and complete the table to show how much ATP is used and produced for each molecule of glucose respired in the various stages of respiration.

	ATP used	ATP produced	net gain in ATP
glycolysis			
link reaction			
Krebs cycle			
oxidative phosphorylation			
total			

7 a Explain why the energy value of lipid is more than twice that of carbohydrate.[2]

b Explain what is meant by **respiratory quotient (RQ)**. [2]

c Copy and complete the table to show that different respiratory substrates have different RQs.

respiratory substrate	RQ
	1.0
	0.7
	0.9

d Measurements of oxygen uptake and carbon dioxide production by germinating seeds in a respirometer showed that 25 cm<sup>3</sup> of oxygen was used and 17.5 cm<sup>3</sup> of

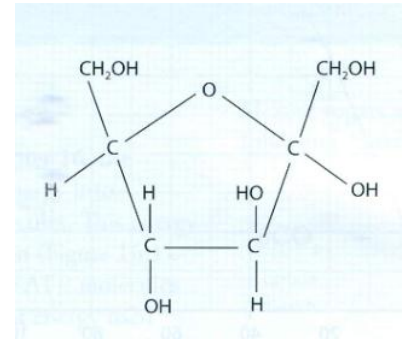

carbon dioxide was produced over the same time period.

i

Calculate the RQ for these seeds. [2]

ii Identify the respiratory substrate used by the seeds. [1]

e Dahlia plants store a compound called inulin, which is a polymer of fructose. The structure of fructose is shown in the diagram.

Calculate the RQ when inulin is hydrolysed and then respired aerobically. [2]

[Total: 12]

## 2. End-of-chapter answers

1 C 2 D 3 D

4 a **energy currency**: immediate donor of energy to all energy-requiring reactions in a cell;

**energy storage**: short-term (glucose, sucrose) or long-term (starch, glycogen, triglyceride) store of chemical potential energy;

b **decarboxylation**: a reaction in which carbon dioxide is removed from a compound;

**dehydrogenation**: a reaction in which hydrogen is removed from a compound;

5 a **NAD**: a hydrogen carrier molecule: it accepts a hydrogen from one reaction and donates it to another;

b **coenzyme A**: a carrier of an acetyl group from the link reaction to the Krebs cycle;

c **oxygen**: the final electron acceptor and hydrogen ion acceptor in oxidative phosphorylation: the oxygen is reduced to water;

6	Feature	ATP used	ATP produced	Net gain in ATP
	glycolysis	-2	+4	+2
	link reaction	0	0	0
	Krebs cycle	0	+2	+2
	oxidative phosphorylation	0	+28	+28
	total	-2	+34	+32

7 a Lipid has more hydrogen atoms per molecule than does carbohydrate;  
most energy liberated in aerobic respiration comes from the oxidation of hydrogen to water; [2]

**b**

$$RQ = \frac{\text{volume of carbon dioxide given out in unit time}}{\text{volume of oxygen taken in in unit time}}$$

or

$$RQ = \frac{\text{moles / molecules of carbon dioxide given in unit time}}{\text{moles / molecules of oxygen taken in in unit time}}$$

[2]

**c**

Respiratory substrate	RQ
carbohydrate	1.0
lipid	0.7
protein	0.9

[3]

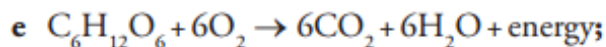

$$\frac{6CO_2}{6H_2O} = 1.0;$$

[2]

**d i**  $RQ = \frac{17.5 \text{ cm}^3}{25 \text{ cm}^3};$   
 $= 0.7;$

[2]

**ii** lipid;

[1]

[Total: 12]

8 a provide hydrogen to reduce NAD and FAD;  
reduced carriers pass to electron transport chain;  
provide energy for ATP synthesis in oxidative phosphorylation;  
refer to chemiosmosis; [max. 3]

b i increasing the concentration of aluminium ions from 0 to 40  $\mu\text{mol}$  increases rate of  
fumarate production;  
increases from 40 to 120  $\mu\text{mol}$  have little effect; [2]  
ii aluminium binds to enzyme/refer to cofactor; optimises shape of active site; [2]

**[Total: 7]**

## CHAPTER 15 – PHOTOSYNTHESIS

## #82 Photosynthesis overview

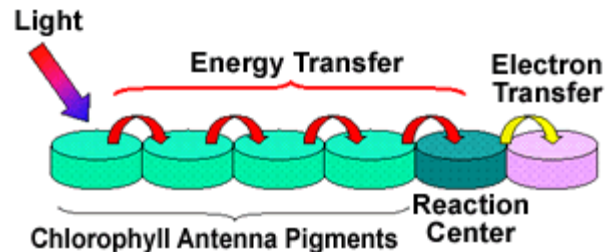

Photosynthesis is a series of reactions in which energy transferred as light is transformed to chemical energy.

Energy from light is trapped by **chlorophyll**, and this energy is then used to

- split apart the strong bonds in water molecules to release **hydrogen**
- produce **ATP**
- reduce a substance called **NADP**.

NADP stands for nicotinamide adenine dinucleotide phosphate, which - like NAD - is a coenzyme.

The **ATP** and **reduced NADP** are then used to add hydrogen to **carbon dioxide**, to produce carbohydrate molecules such as **glucose**. These complex organic molecules contain some of the energy that was originally in the light. The **oxygen** from the split water molecules is a waste product, and is released into the air.

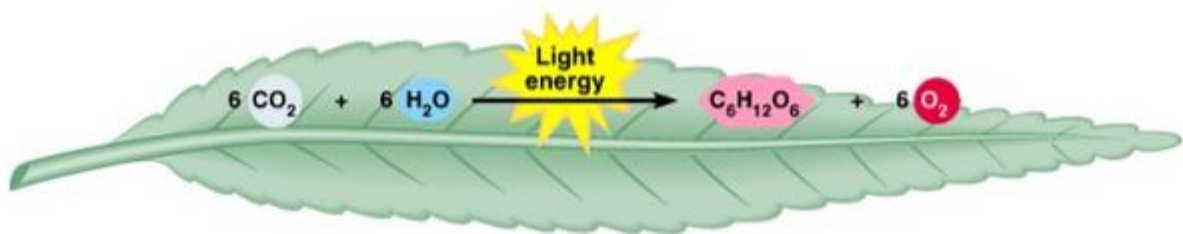

There are three basic steps in photosynthesis:

1. **Light-dependent reactions** - energy capture chemiosmosis generation of ATP (adenosine triphosphate) from harvested sunlight
2. **Light-independent reactions** - fixation of carbon enzyme catalyzed reactions using the energy formed (ATP) in the light reactions to fix atmospherically derived carbon ( $\text{CO}_2$ ) into sugars ( $\text{CH}_2\text{O}$ )

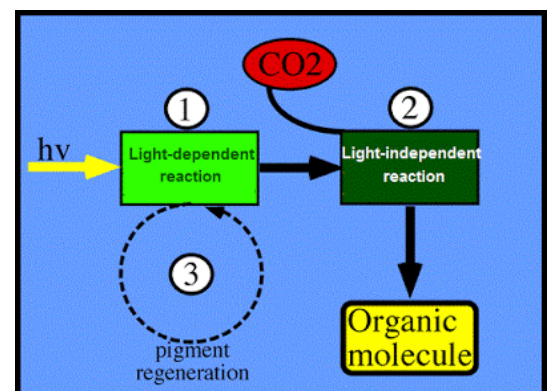

**3. Pigment Regeneration** - electron replacement from the splitting of H<sub>2</sub>O in oxygenic photosynthesis.

The 2 main stages are light-dependent reactions and light-independent reactions (Calvin cycle).

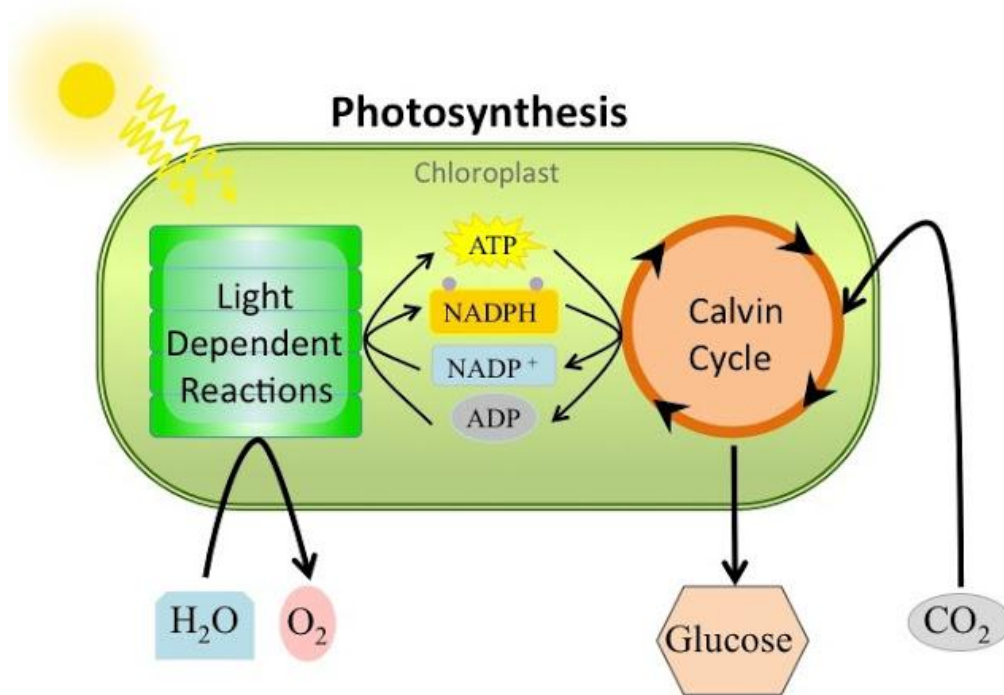



## #83 Chloroplasts

Photosynthesis takes place inside **chloroplasts**.



These are organelles surrounded by 2 membranes, called an **envelope**.

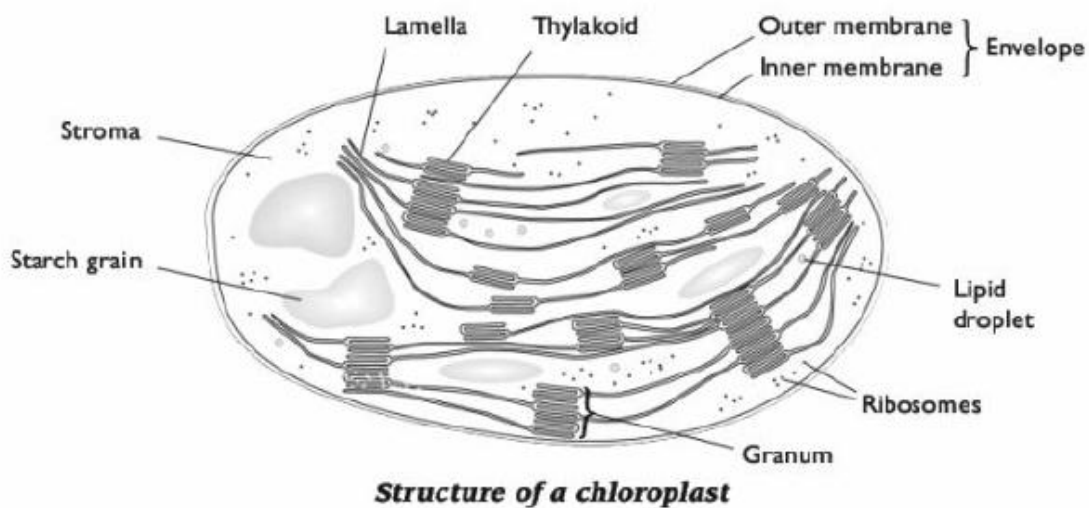

Chloroplasts are found in mesophyll cells in leaves:

- **Palisade mesophyll** cells contain most chloroplasts.
- **Spongy mesophyll** cells and **Guard** cells also contain chloroplasts.

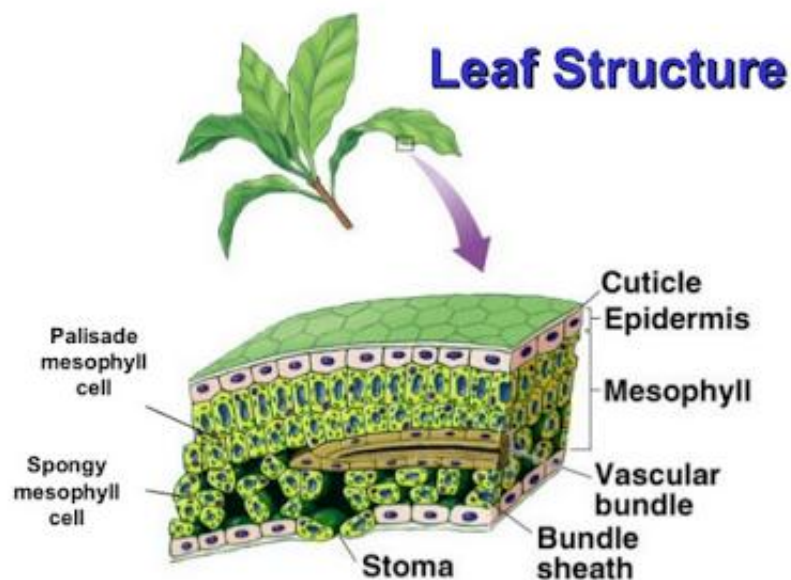

## Lamellae and light-dependent reactions

The membranes inside a chloroplast are called **lamellae**, and it is here that the **light-dependent** reactions take place. The membranes contain chlorophyll molecules, arranged in groups called **photosystems**. There are two kinds of photosystems, PSI and PSII, each of which contains slightly different kinds of chlorophyll.

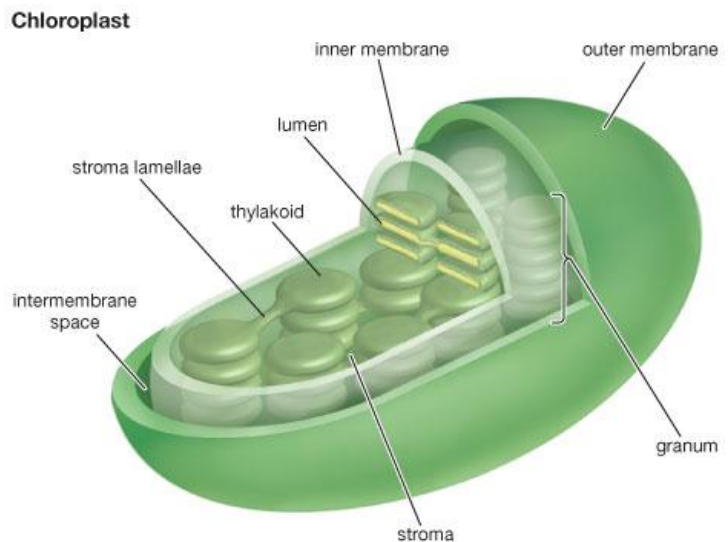

There are enclosed spaces between pairs of membranes, forming fluid-filled sacs called **thylakoids**. These are involved in photophosphorylation - the formation of ATP using energy from light. Thylakoids are often arranged in stacks called **grana** (singular: granum).

## Stroma and light-independent reactions

The 'background material' of the chloroplast is called the **stroma**, and this is where the **light-independent** reactions take place.

Chloroplasts often contain **starch grains** and **lipid droplets**. These are stores of energy-containing substances that have been made in the chloroplast but are not immediately needed by the cell or by other parts of the plant.

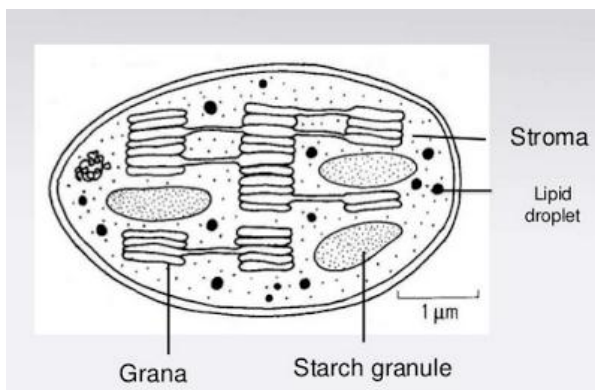
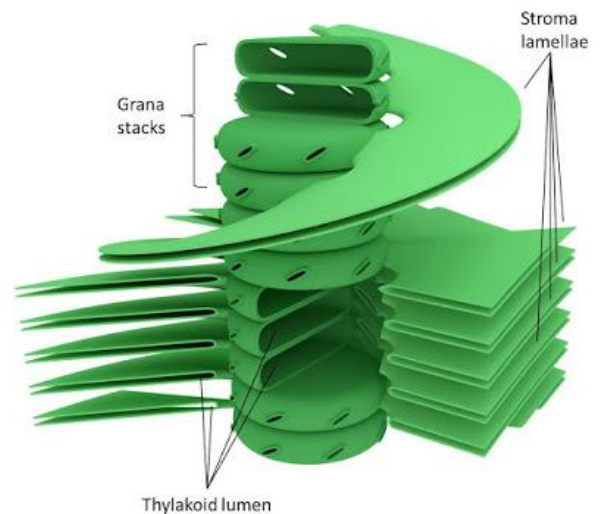

## #84 Photosynthetic Pigments

**Photosynthetic pigments** are pigments presented in chloroplasts or photosynthetic bacteria. They capture **light energy** necessary for photosynthesis and convert it to **chemical energy**.

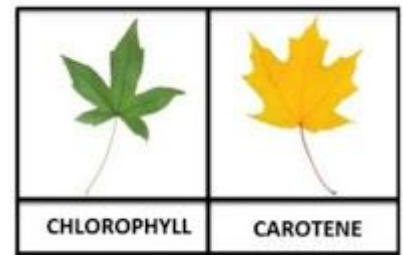

### Pigments

- A pigment is any substance that absorbs light.
- The color of the pigment comes from the wavelengths of light that are reflected (not absorbed).
- If pigments absorb all wavelengths they will appear black.
- If pigments reflect most of the wavelengths they will appear white.
- The light absorption pattern of a pigment is called the absorption spectrum.

When pigments absorb light, electrons are temporarily boosted to a higher energy level. Energized electrons move further from the nucleus of the atom. When the e<sup>-</sup> returns to a lower energy level the energy may be:

- dissipated as heat
- re-emitted as a longer wavelength of light - fluorescence
- captured in a chemical bond (carbon gain!)

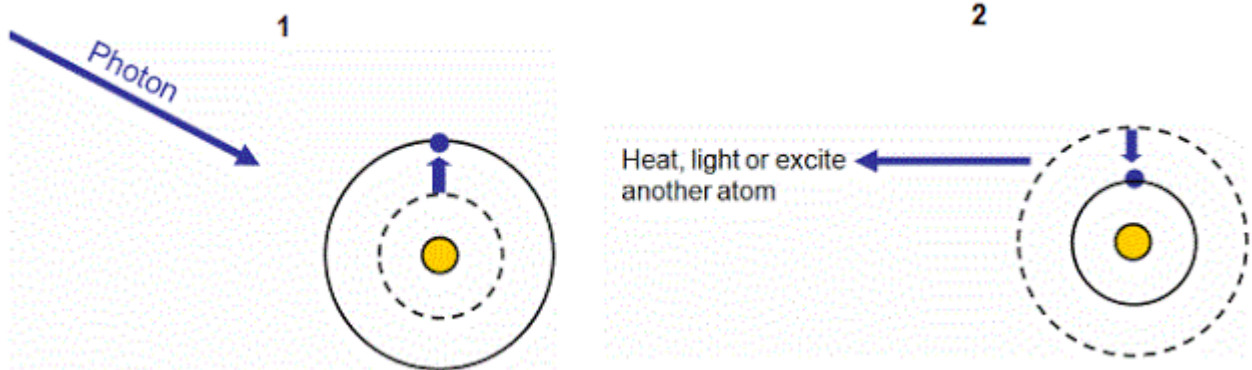

### Photosynthetic pigments in chloroplast

Chloroplasts contain several different pigments, which absorb different wavelengths of light. The photosynthetic pigments of higher plants form 2 groups: the **chlorophylls** and the **carotenoids**.

**1. Chlorophylls** absorb mainly red and blue-violet light, reflect green light - giving green leaves their colour.

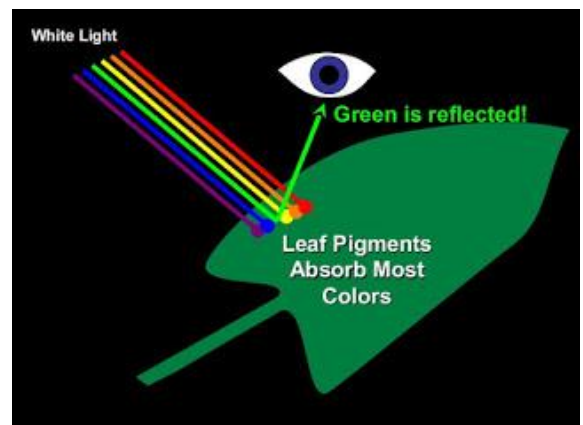

**2. Carotenoids:** orange pigments that protect chlorophyll from damage by the formation of single oxygen atoms (free radicals). They can also absorb wavelengths of light that chlorophyll cannot absorb, and pass on some of the energy from the light to chlorophyll. They absorb strongly in the blue-violet range. Carotenoids are usually masked by the green chlorophylls.

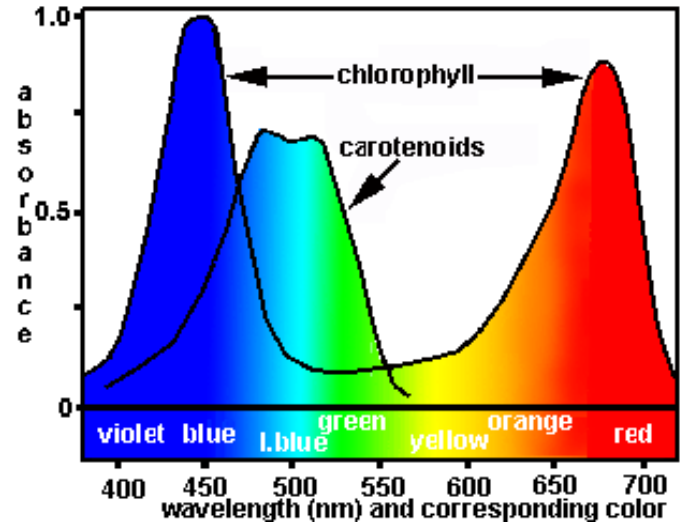

There are 2 types of carotenoid:

- carotenes ( $\beta$ -carotene)
- xanthophylls.

Group	Pigment	Colour
chlorophylls:	chlorophyll <i>a</i>	yellow-green
	chlorophyll <i>b</i>	blue-green
carotenoids:	$\beta$ carotene	orange
	xanthophyll	yellow

The colours of the commonly occurring photosynthetic pigments.

### *Main and accessory photosynthetic pigments*

#### - Main pigment

- **Chlorophyll a** is the most abundant pigment in most plants. Its absorption peaks are 430nm (blue) and 662nm (red). It emits an electron when it absorbs light.

#### - Accessory pigments

- **Chlorophyll b** is similar to chlorophyll a, but its absorption peaks are 453nm and 642nm. It has a similar role to chlorophyll a, but is not as abundant.
- **Carotenoids** : carotene and **Xanthophylls**.

The combination of all of the pigments increases the range of colors that plants can use in photosynthesis.

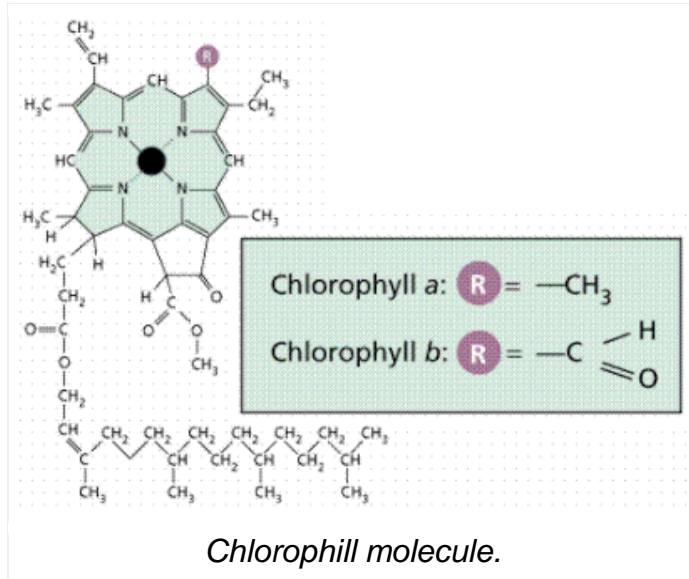

### Absorption spectrum and action spectrum of chloroplast pigments

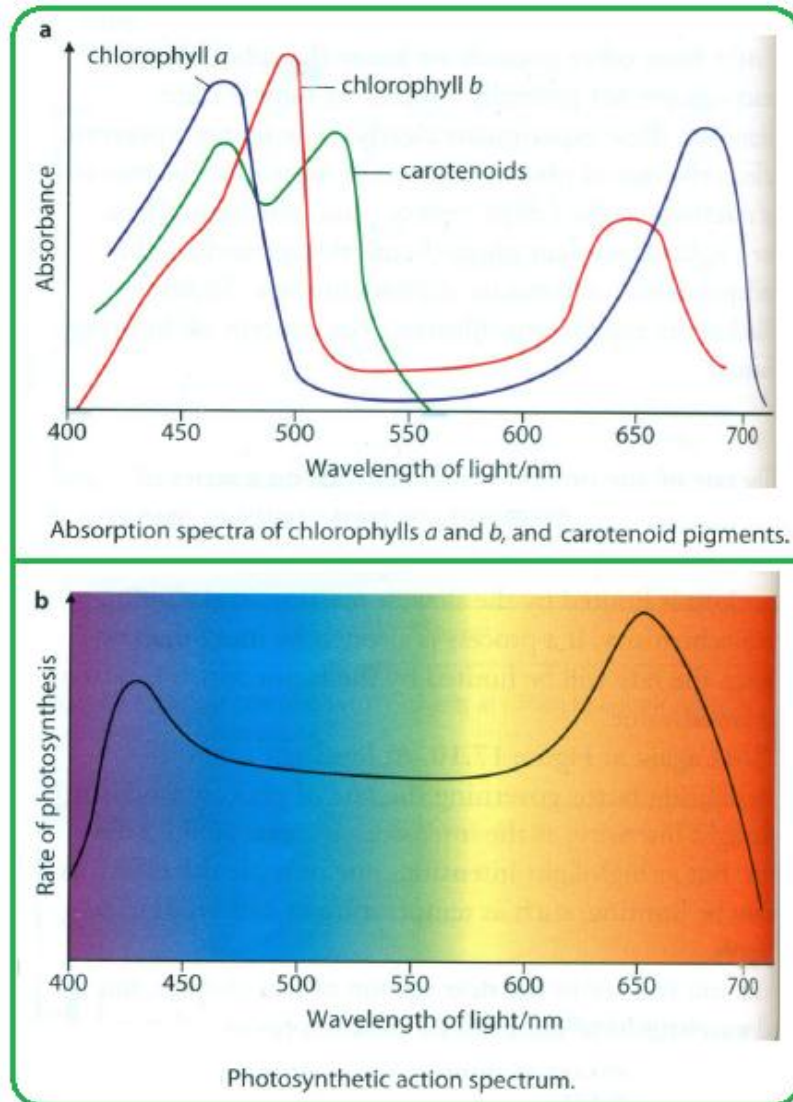

An **absorption spectrum** is a graph showing the **percentage of light absorbed** by pigments, for each wavelength of light.

An example is the absorption spectrum of chlorophyll a and b.

- The best absorption is seen with violet-blue light.
- There is also good absorption with red-orange light.
- Most of the green-yellow light is reflected and therefore not absorbed. This wavelength of light shows the least absorption.

The **action spectrum** of photosynthesis is a graph showing the **rate of photosynthesis** for each wavelength of light. The rate of photosynthesis will not be the same for every wavelength of light.

- The rate of photosynthesis is the least with green-yellow light (525 nm-625 nm).
- Red-orange light (625nm-700nm) shows a good rate of photosynthesis.
- The best rate of photosynthesis is seen with violet-blue light (400nm-525nm).

The wavelengths that it does not absorb are reflected from it.

Chlorophyll is the main pigment contained in chloroplasts. It looks green because it reflects green light. Other wavelengths (colours) of light are absorbed.

The diagram shows the wavelengths of light absorbed by the various pigments found in chloroplasts. These graphs are called absorption spectra.

If we shine light of various wavelengths on chloroplasts containing different pigments, we can measure the rate at which they give off oxygen. These graphs are called action spectra.

## # 85 The light-dependent reactions, Photophosphorilation

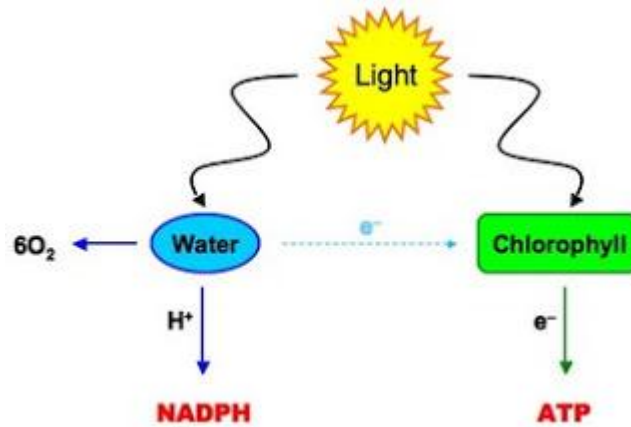

Chlorophyll molecules in photosystem I (PSI) and photosystem II (PSII) absorb light energy. The energy excites electrons, raising their energy level so that they leave the chlorophyll. The chlorophyll is said to be photo-activated.

PSII contains an enzyme that splits water when activated by light. This reaction is called **photolysis** ('splitting by light'). The water molecules are split into oxygen and hydrogen atoms. Each hydrogen atom then loses its electron, to become a positively charged hydrogen ion (proton), H<sup>+</sup>.

The electrons are picked up by the chlorophyll in PSI, to replace the electrons they lost. The oxygen atoms join together to form oxygen molecules, which diffuse out of the chloroplast and into the air around the leaf.

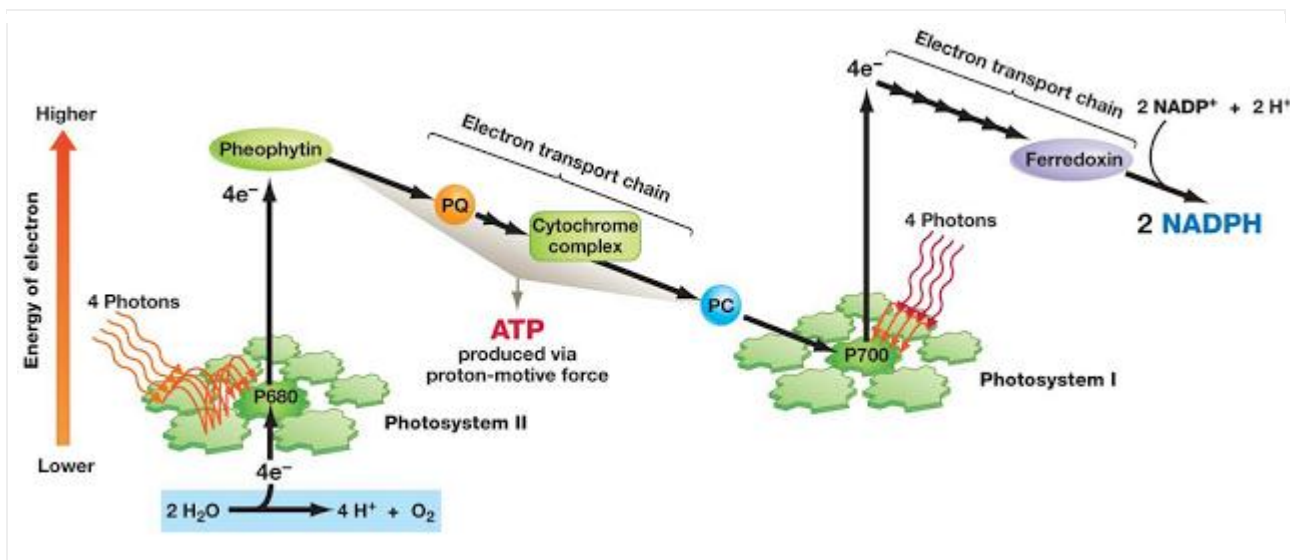

*The light- dependent reactions. Credit: Pears education.*

The electrons emitted from PSII are picked up by electron carriers in the membranes of the thylakoids. They are passed along a chain of these carriers, losing energy as they go. The energy they lose is used to make ADP combine with a phosphate group, producing ATP. This is called **photophosphorylation**. At the end of the electron carrier chain, the electron is picked up by PSI, to replace the electron the chlorophyll in PSI had lost.

The electrons from PSI are passed along a different chain of carriers to NADP. The NADP also picks up the hydrogen ions from the split water molecules. The NADP becomes reduced NADP.

We can show all of this in a diagram called the **Z-scheme**. The higher up the diagram, the higher the energy level. If you follow one electron from a water molecule, you can see how it

- is taken up by PSII
- has its energy raised as the chlorophyll in PSII absorbs light energy
- loses some of this energy as it passes along the electron carrier chain
- is taken up by PSI
- has its energy raised again as the chlorophyll in PSI absorbs light energy
- becomes part of a reduced NADP molecule

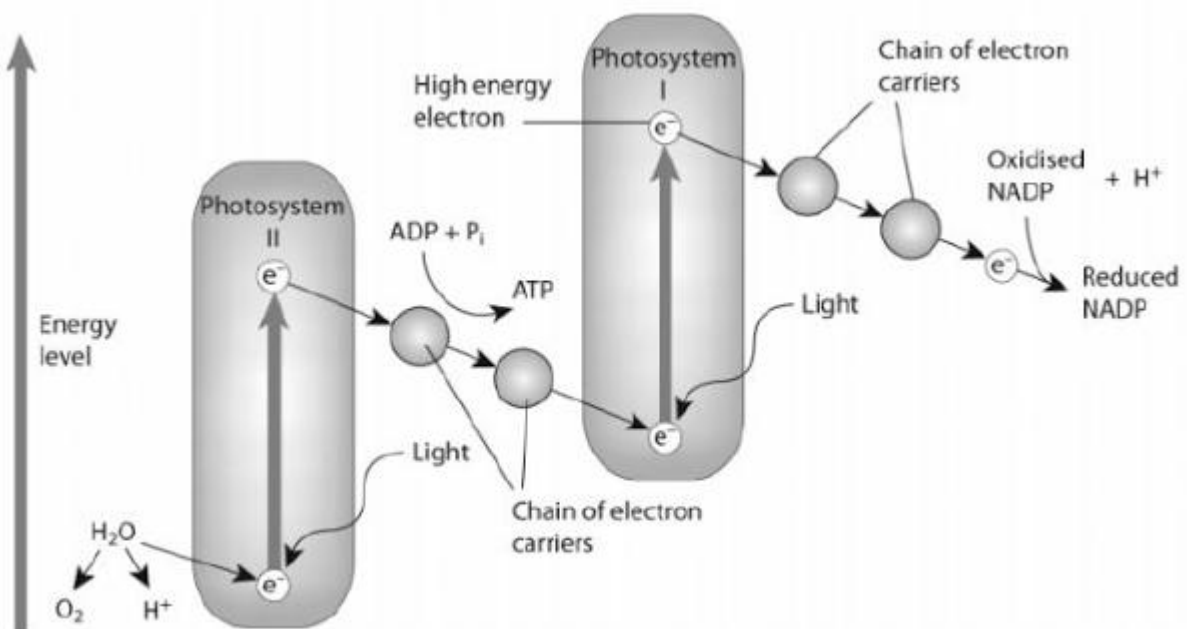

**Summary of the light-dependent reactions of photosynthesis — the Z-scheme**

At the end of this process, two new substances have been made. These are **ATP** and reduced **NADP**. Both of them will now be used in the next stage of photosynthesis, the light-independent reactions.



## Non-cyclic and cyclic photophosphorylation

The sequence of events just described and shown in the flow diagram above is known as **non-cyclic photophosphorylation**.

There is an alternative pathway for the electron that is emitted from PSI. It can simply be passed along the electron transport chain, then back to PSI again. ATP is produced as it moves along the electron transport chain (photophosphorylation). However, no reduced NADP is produced. This is called **cyclic photophosphorylation**.

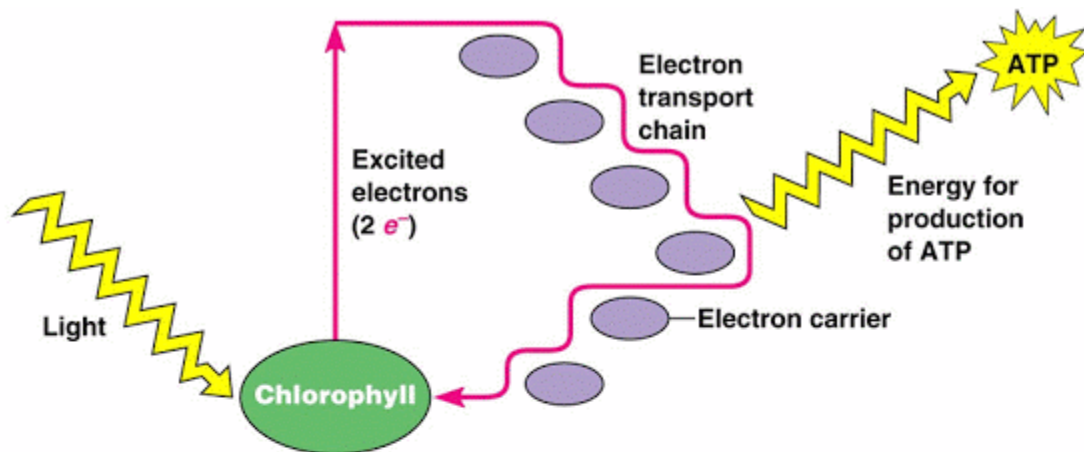

(a) Cyclic photophosphorylation

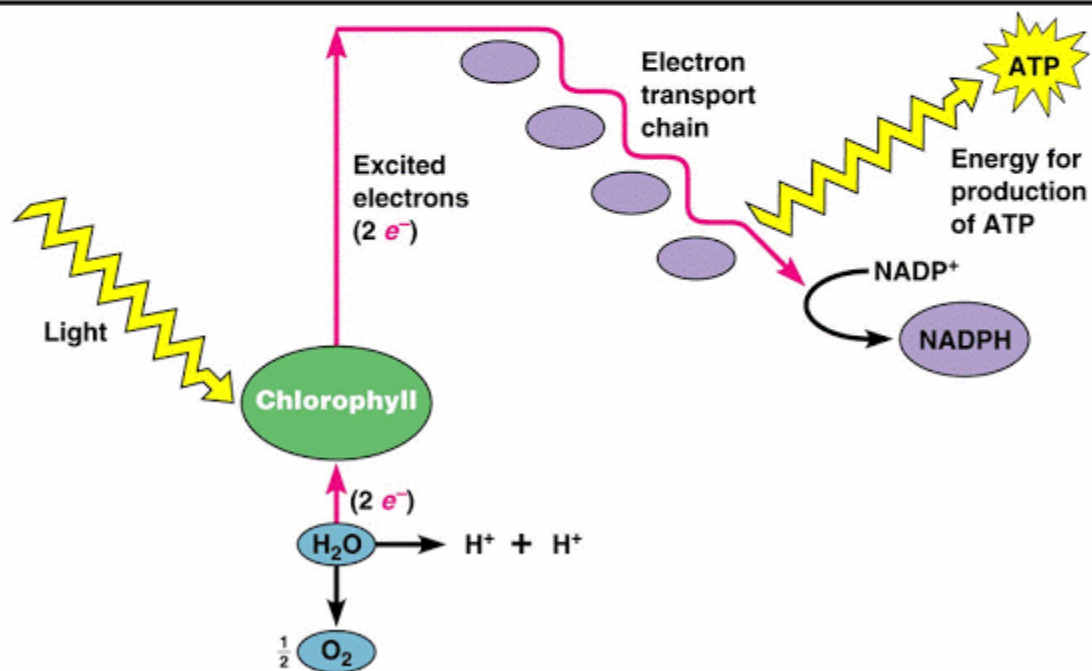

(b) Noncyclic photophosphorylation

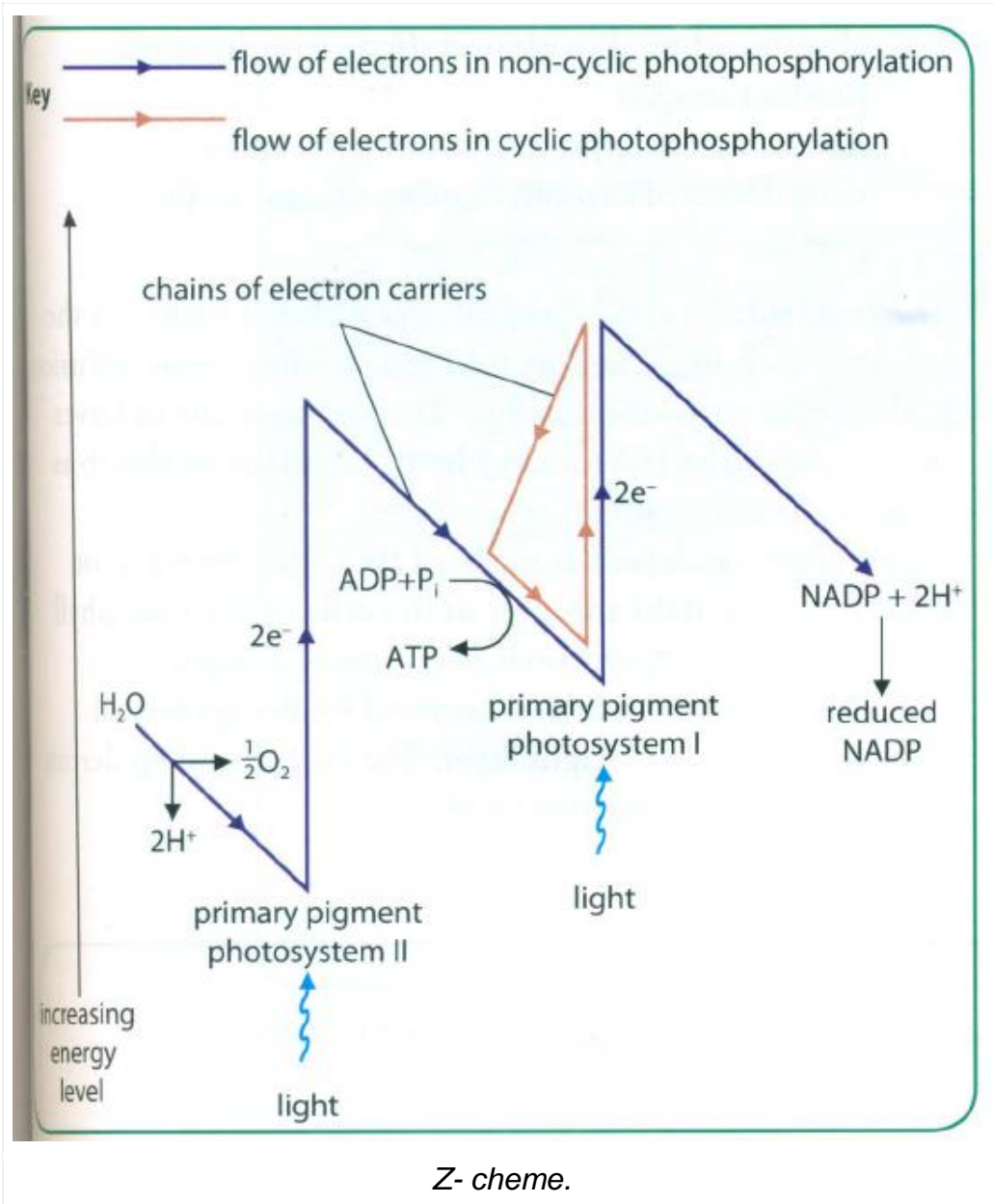

**Video: Photosynthesis**

<https://www.youtube.com/watch?v=YeD9idmcX0w>

## #86 The light-independent reactions (Calvin cycle)

The **light-independent reactions** take place in the stroma of the chloroplast, where the enzyme **ribulose biphosphate carboxylase**, usually known as **rubisco**, is found.

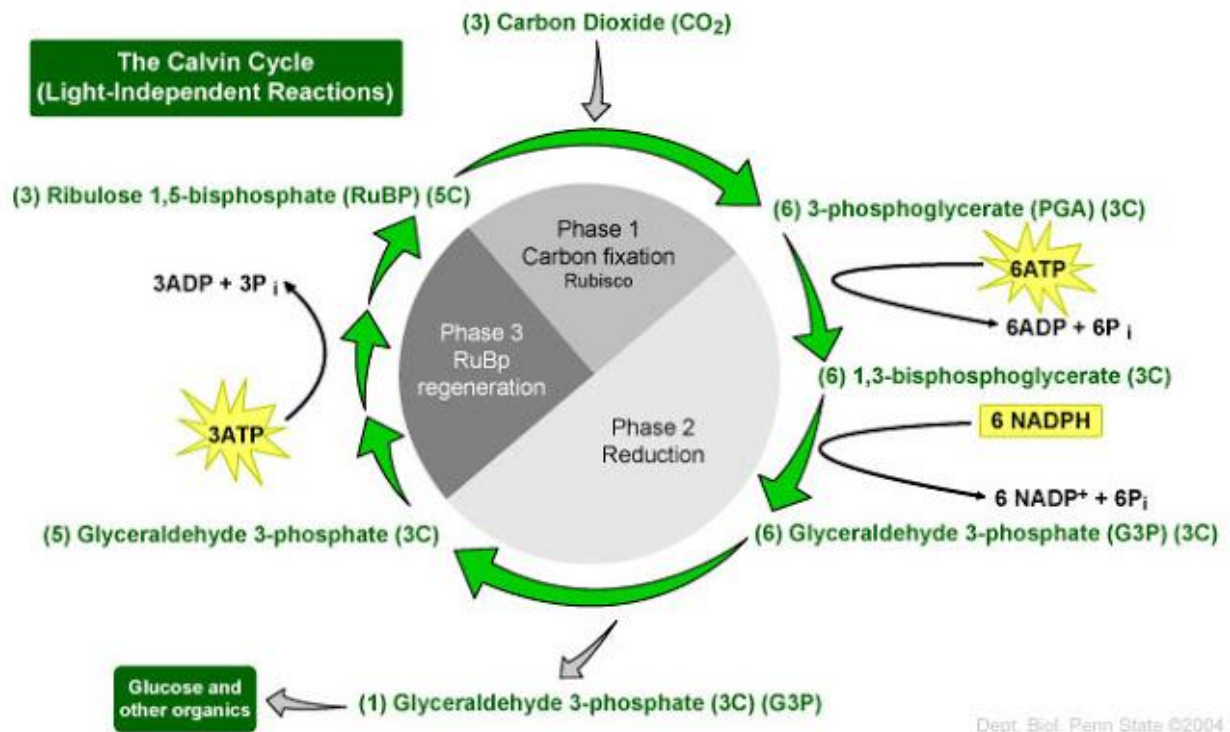
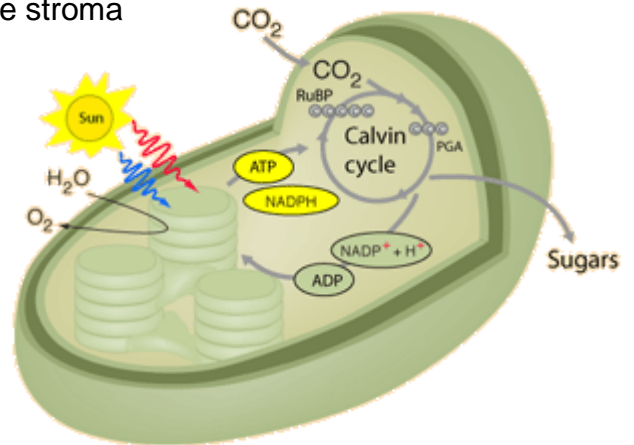

Dept. Biol. Penn State ©2004

### 1. Carbon fixation

CO<sub>2</sub> diffuses into the stroma from the air spaces within the leaf. It enters the active site of **rubisco**, which combines it with a 5-carbon compound called **ribulose biphosphate, RuBP**. The reaction is called **carbon fixation**.

The products of this reaction are two 3-carbon molecules, glycerate 3-phosphate, **GP**.

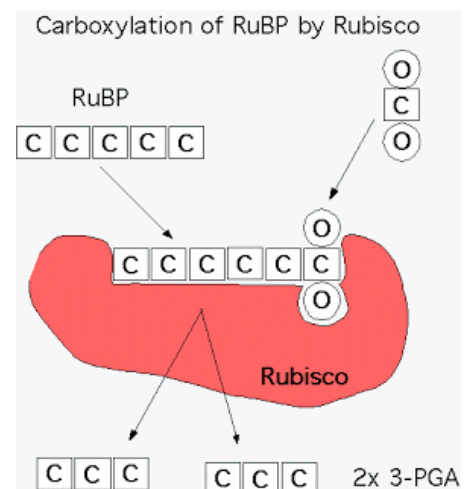

## 2. Reduction

Energy from **ATP** and hydrogen from **reduced NADP** are then used to convert the GP into **triose phosphate, TP**. Triose phosphate is the first carbohydrate produced in photosynthesis.

## 3. RuBP regeneration

Most of the triose phosphate is used to produce ribulose bisphosphate (**RuBP**), so that more carbon dioxide can be fixed.

The rest is used to make **glucose** or whatever other organic substances the plant cell requires. These include:

- polysaccharides such as **starch** for energy storage and **cellulose** for making cell walls,
- **sucrose** for transport,
- amino acids for making proteins,
- lipids for energy storage
- nucleotides for making DNA and RNA.

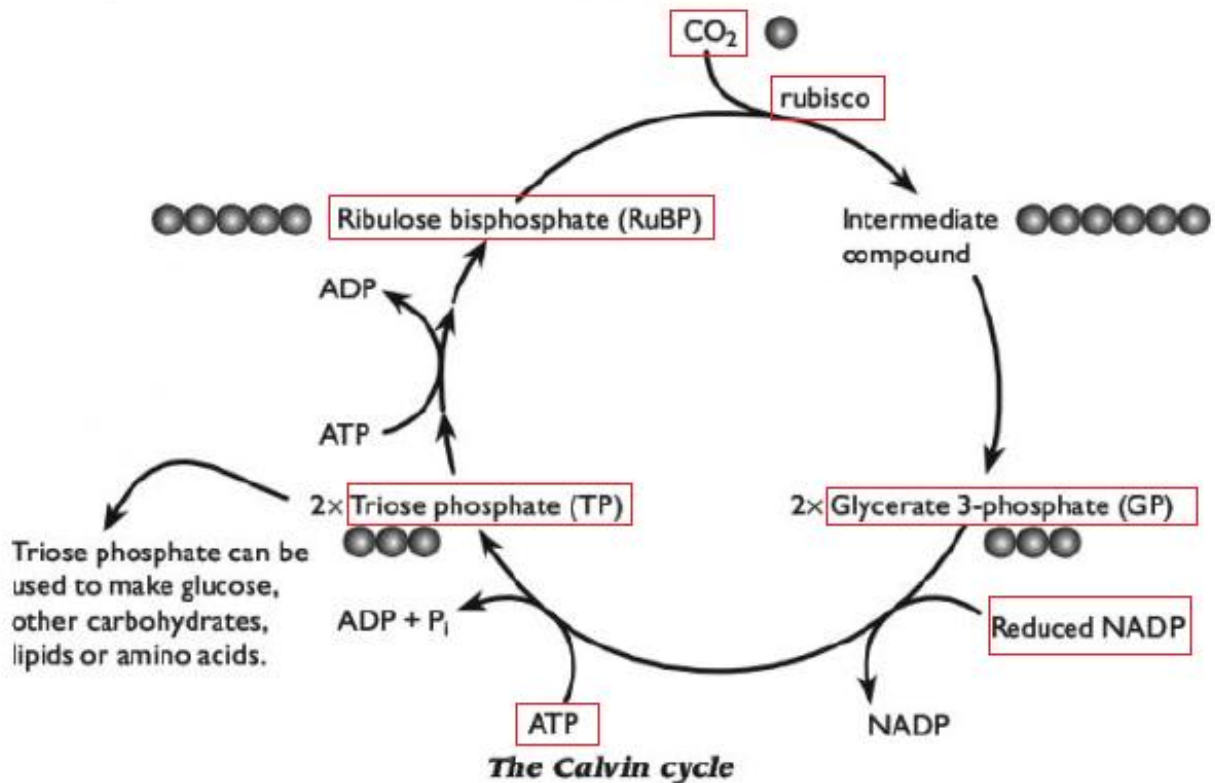

## #87 Separating chlorophyll pigments by Thin layer chromatography (TLC)

**Chromatography** is a method of separation that relies on the different solubilities of different solutes in a solvent. A mixture of **chlorophyll pigments** is dissolved in a solvent, and then a small spot is placed onto **chromatography paper**. The solvent gradually moves up the paper, carrying the solutes with it. The more soluble the solvent, the further up the paper it is carried.



Paper chromatography is a useful technique in the separation and identification of different plant pigments.

- In this technique, the mixture containing the pigments to be separated is first applied as a spot or a line to the paper about 1.5 cm from the bottom edge of the paper.
- The paper is then placed in a container with the tip of the paper touching the solvent. Solvent is absorbed by the paper and moves up the paper by capillary action.
- As the solvent crosses the area containing plant pigment extract, the pigments dissolve in and move with the solvent.
- The solvent carries the dissolved pigments as it moves up the paper. The pigments are carried along at different rates because they are not equally soluble. Therefore, the less soluble pigments will move slower up the paper than the more soluble pigments. This is known as developing a chromatogram.

There are various methods. The one described here uses **Thin layer chromatography (TLC)** on specially prepared strips instead of paper. It is a chromatography technique for analyzing mixtures by separating the compounds in the mixture. TLC can be used to help determine the number of components in a mixture, the identity of compounds, and the purity of a compound. During chromatography, a mobile phase (eluent) distributes the compounds present in a mixture over a stationary phase (adsorbent).

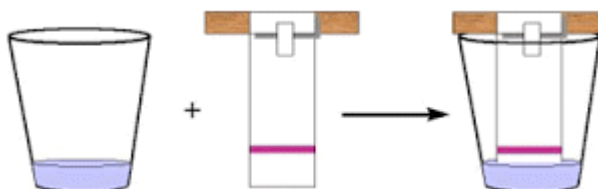

The **distance** traveled by a particular compound can be used to identify the **compound**. The ratio of the distance traveled by a compound to that of the solvent front is known as the  $R_f$  value; unknown compounds may be identified by comparing their  $R_f$ 's to the  $R_f$ 's of known standards.

Rf equation:

$$R_f = \frac{\text{distance traveled by compound}}{\text{distance traveled by solvent}}$$

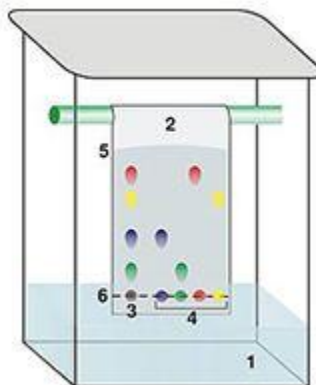

Only an outline of the procedure is given here, so you cannot use these instructions to actually carry out the experiment.

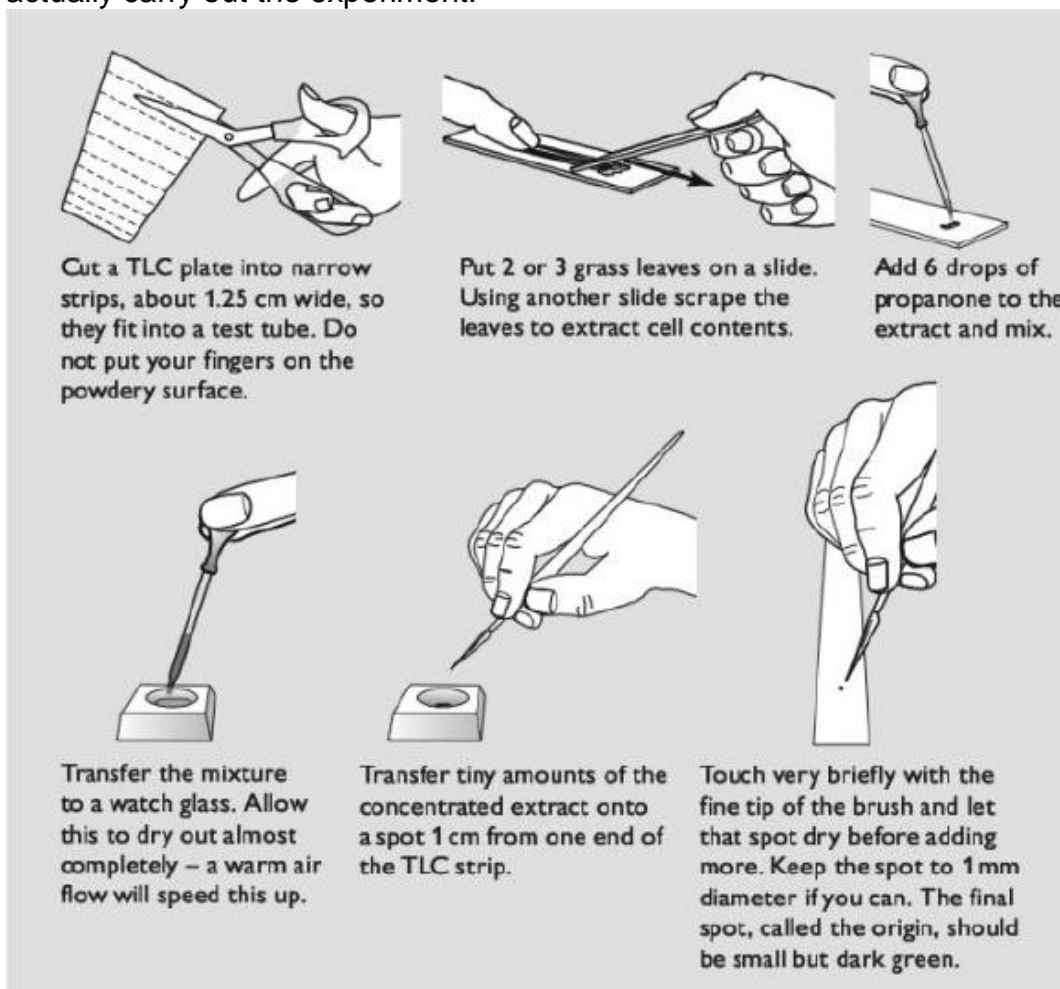

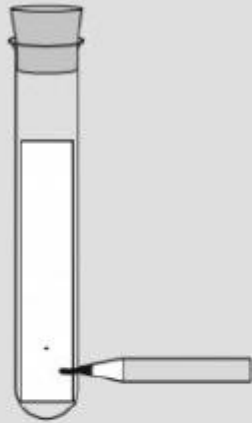

Put the TLC strip in a test tube. Mark the tube below the pigment spot and remove the TLC strip.



Add the running solvent to the depth of the mark, then return the TLC strip to the tube and seal it.



After about 4 minutes remove the TLC strip. Immediately mark the solvent front with a needle. You can also mark the centres of the pigment spots and the origin.

- Measure the distance from the start line to the solvent front. Measure the distances of each pigment spot from the start line. For each spot, calculate the R<sub>f</sub> value:

$$R_f = \frac{\text{distance from start line to pigment spot}}{\text{distance from start line to solvent front}}$$

- You can use the R<sub>f</sub> values to help you to identify the pigments. R<sub>f</sub> values differ depending on the solvent you have used, but typical values might be:

chlorophyll a	0.60
chlorophyll b	0.50
carotene	0.95
xanthophyll	0.35

You may also see a small grey spot with an R<sub>f</sub> value of about 0.8. This is phaeophytin, which is not really a chlorophyll pigment, but is a breakdown product generated during the extraction process.

### Video TLC

<https://www.youtube.com/watch?v=CmHFVxTxkGs>

[https://www.youtube.com/watch?v=rpb\\_Qc4jMAc](https://www.youtube.com/watch?v=rpb_Qc4jMAc)

## #88 Limiting factors in photosynthesis

A limiting factor is a factor that controls a process. **Light intensity**, **temperature** and, **CO<sub>2</sub>** concentration and availability of **H<sub>2</sub>O** are all factors which can control the rate of photosynthesis.

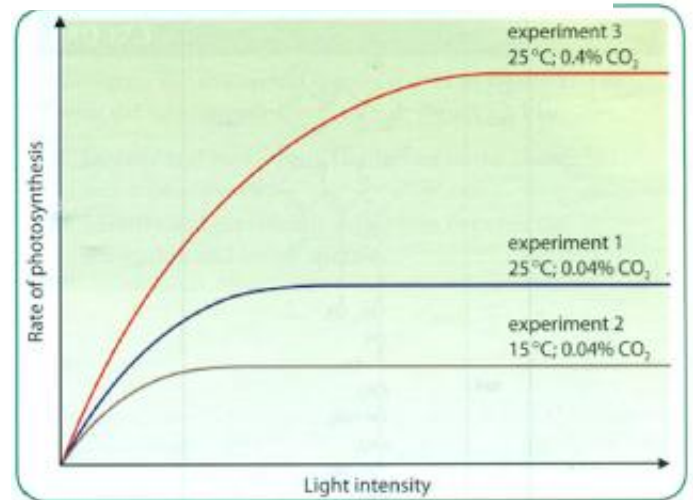

Usually, only one of these factors will be the limiting factor in a plant at a certain time. This is the factor which is the furthest from its optimum level at a particular point in time. If we change the limiting factor the rate of photosynthesis will change but changes to the other factors will have no effect on the rate.

If the levels of the **limiting factor** increase so that this factor is no longer the furthest from its optimum level, the limiting factor will change to the factor which is at that point in time, the furthest from its optimum level. For example, at night the limiting factor is likely to be the light intensity as this will be the furthest from its optimum level. During the day, the limiting factor is likely to switch to the temperature or the carbon dioxide concentration as the light intensity increases.

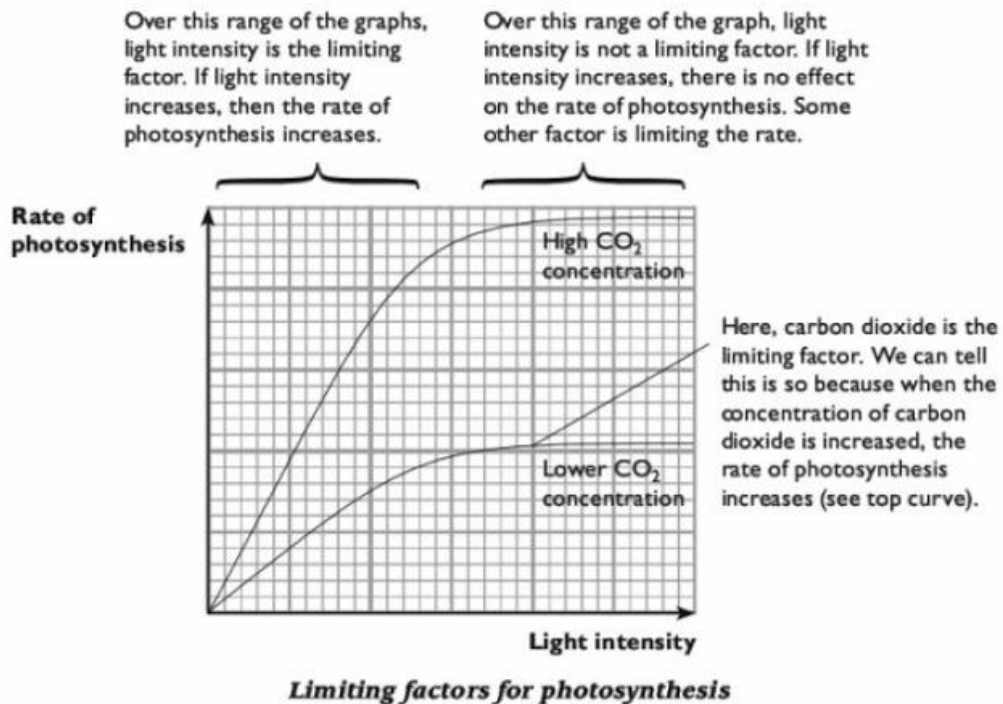



## Effects of changes in light intensity, CO<sub>2</sub>, H<sub>2</sub>O and temperature on the rate of photosynthesis

### 1. Light intensity

- This affects the rate of the **light-dependent reaction**. The energy that drives this process is light energy.
- When the light intensity is poor, there is a shortage of ATP and NADPH, as these are products from the light dependent reactions. Without these products the light independent reactions can't occur as glycerate 3-phosphate cannot be reduced. Therefore a shortage of these products will limit the rate of photosynthesis.

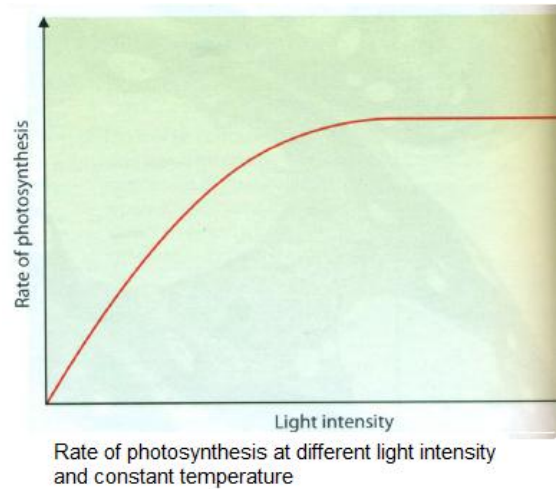

### 2. Temperature

- This affects the rate of the **light-independent reaction**. The energy that drives this process is heat energy.
- At higher temperatures, molecules have more kinetic energy so collide more often and are more likely to react when they do collide.
- Many enzymes are involved during the process of photosynthesis. At low temperatures these enzymes work slower. At high temperatures the enzymes no longer work effectively. This affects the rate of the reactions in the Calvin cycle and therefore the rate of photosynthesis will be affected.

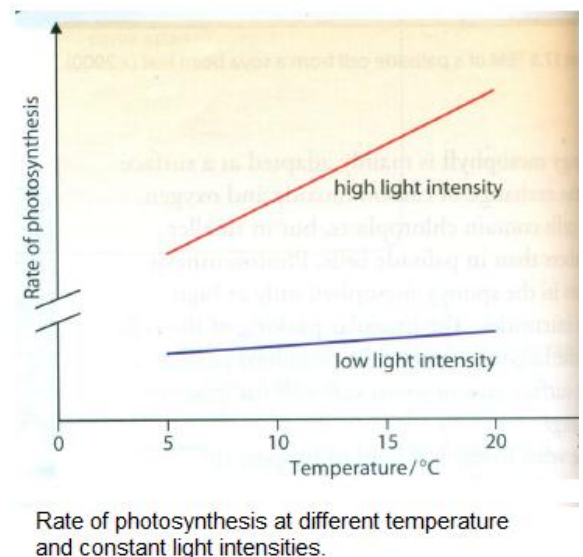

### 3. CO<sub>2</sub> concentration

- CO<sub>2</sub> is a reactant in photosynthesis. Normal air contains only about 0.04% CO<sub>2</sub>.
- When the CO<sub>2</sub> concentration is low, the amount of glycerate 3-phosphate produced is limited as CO<sub>2</sub> is needed for its production and therefore the rate of photosynthesis is affected.

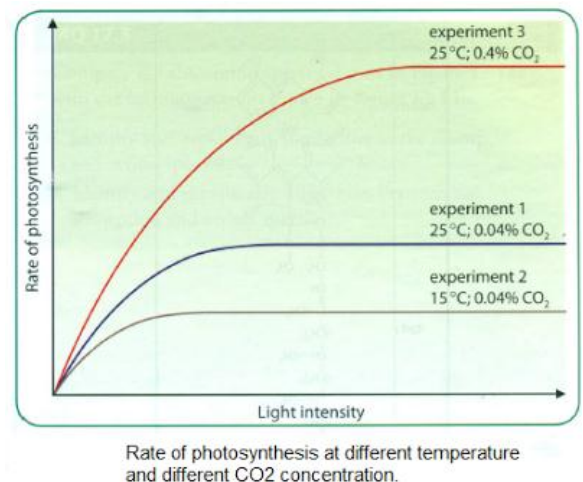

#### 4. Availability of H<sub>2</sub>O

H<sub>2</sub>O is a reactant in photosynthesis, but there is usually far more H<sub>2</sub>O available than CO<sub>2</sub>, so even if water supplies are low this is not usually a problem. However, water supply can affect the rate of photosynthesis indirectly, because a plant that is short of water will close its stomata, preventing CO<sub>2</sub> from diffusing into the leaf.

If the level of anyone of these factors is too low, then the rate of photosynthesis will be reduced. The factor that has the greatest effect in reducing the rate is said to be the limiting factor.

#### Economics of greenhouses

Farmers can use their knowledge of factors limiting the rate of photosynthesis to **increase crop yields**. This is particularly true in greenhouses, where the conditions are more easily controlled than in the open air outside:

- The use of **artificial light** allows photosynthesis to continue beyond daylight hours. Bright lights also provide a higher-than-normal light intensity.
- The use of **artificial heating** allows photosynthesis to continue at an increased rate.
- The use of **additional CO<sub>2</sub>** released into the atmosphere inside the greenhouse also allows photosynthesis to continue at an increased rate.



*Artificial light in the green house.*

However, the additional cost of providing extra lighting, heat and CO<sub>2</sub> has to be weighed against the increased crop yield and the extra income it will provide. The cost of should not exceed the additional income it generates for the farmer.

In practice, the farmer will need to find the optimum growing conditions for the crop, given the costs of providing extra lighting, heat and CO<sub>2</sub>. Paraffin lamps have traditionally been used in greenhouses. Their use increases the rate of photosynthesis because as well as the light generated from the lamps, the burning paraffin produces heat and CO<sub>2</sub> too.

### Investigating the effect of environmental factors on the rate of photosynthesis

One way to measure the rate of photosynthesis is to measure the rate at which oxygen is given off by an aquatic plant. There are various ways in which oxygen can be collected and measured. One method is shown in the diagram below.

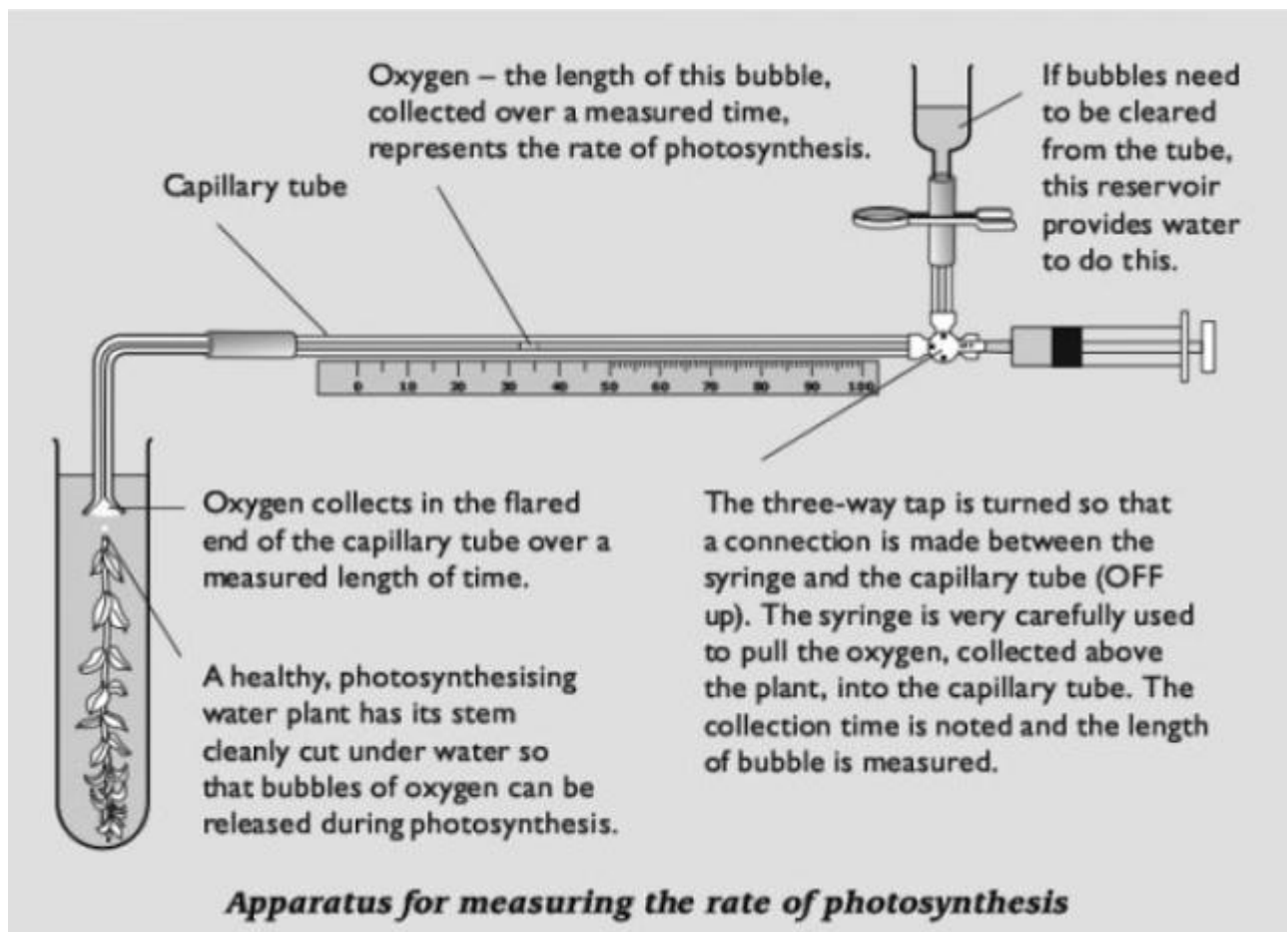

Alternatively, you can make calcium alginate balls containing green algae and place them in hydrogencarbonate indicator solution. As the algae photosynthesise, they take in carbon dioxide which causes the pH around them to increase. The indicator changes from orange, through red to magenta.

Whichever technique is used, you should change one factor (your independent variable) while keeping all others constant (the control variables). The dependent variable will be the rate at which oxygen is given off (measured by the volume of oxygen collected per minute in the capillary tube) or the rate at which carbon dioxide is used (measured by the rate of change of colour of

the hydrogencarbonate indicator solution).

The independent variables you could investigate are:

- **Light intensity.** You can vary this by using a lamp to shine light onto the plant or algae. The closer the lamp, the higher the light intensity.
- **Wavelength of light.** You can vary this by placing coloured filters between the light source and the plant. Each filter will allow only light of certain wavelengths to pass through.
- **CO<sub>2</sub> concentration.** You can vary this by adding sodium hydrogencarbonate to the water around the aquatic plant. This contains hydrogencarbonate ions, which are used as a source of carbon dioxide by aquatic plants.
- **Temperature.** The part of the apparatus containing the plant or algae can be placed in a water bath at a range of controlled temperatures.

**Video: Limiting factors of photosynthesis**

<https://www.youtube.com/watch?v=go8V2GQq268>

## #89 Summary of Photosynthesis

1 In photosynthesis, light energy is absorbed by chlorophyll pigments and converted to chemical energy, which is used to produce complex organic molecules.

2 In the light-dependent reactions, water is split by photolysis to give hydrogen ions, electrons and oxygen. The hydrogen ions and electrons are used to reduce the carrier molecule, NADP, and the oxygen is given off as a waste product.

3 ATP is synthesised in the light-dependent reactions of cyclic and non-cyclic photophosphorylation. During these reactions the photosynthetic pigments of the chloroplast absorb light energy and give out excited electrons. Energy from the electrons is used to synthesise ATP.

4 ATP and reduced NADP are the two main products of the light-dependent reactions of photosynthesis, and they then pass to the light-independent reactions.

5 In the light-independent reactions, carbon dioxide is trapped by combination with a 5C compound, RuBP, which acts as an acceptor molecule. This reaction is catalysed by the enzyme ribulose biphosphate carboxylase (rubisco), which is the most common enzyme in the world. The resulting 6C compound splits to give two molecules of a 3C compound, GP (also known as PGA). GP is reduced to carbohydrate, using ATP and reduced NADP from the light-dependent reactions. This carbohydrate can be converted into other carbohydrates, amino acids and lipids or used to regenerate RuBP. This sequence of light-independent events is called the Calvin cycle.

6 Chloroplasts, palisade mesophyll cells and whole leaves are all adapted for the efficient absorption of light for the process of photosynthesis.

7 When a process is affected by more than one factor, the rate of the process will be limited by the factor closest to its lowest value. The rate of photosynthesis is subject to various such limiting factors, including light intensity and wavelength, carbon dioxide concentration and temperature.

8 A graph of the particular wavelengths of light that are absorbed by a photosynthetic pigment is called an absorption spectrum, and a graph of the rate of photosynthesis at different wavelengths of light is called an action spectrum.

9 The different pigments present in a chloroplast can be separated by paper chromatography.

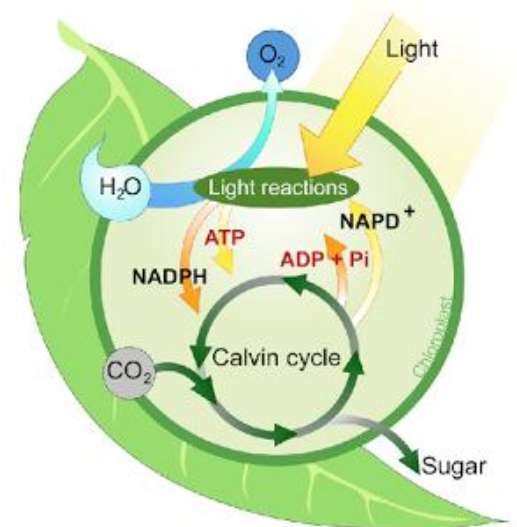

## 1. End-of-chapter questions

1 What are the products of the light-dependent reactions of photosynthesis?

- A ATP, RuBP and reduced NAD
- B ATP, oxygen and reduced NADP
- C GP, oxygen and reduced NAD
- D GP, reduced NADP and RuBP

2 Where in the chloroplast are the products of photophosphorylation used?

- A envelope
- B granum
- C stroma
- D thylakoid

3 In parate

experiments, an actively photosynthesising plant was supplied with one of two labelled reactants:

- water containing the  $^{18}\text{O}$
- carbon dioxide containing the  $^{17}\text{O}$

In which products of photosynthesis would these isotopes be found?

	$^{18}\text{O}$	$^{17}\text{O}$
A	oxygen produced by chloroplast grana	carbohydrate produced by the chloroplast stroma
B	oxygen produced by the chloroplast stroma	carbohydrate produced by chloroplast grana
C	carbohydrate produced by chloroplast grana	oxygen produced by the chloroplast stroma
D	carbohydrate produced by the chloroplast stroma	oxygen produced by chloroplast grana

4 Copy and complete the table to show how the adaptations of a dicotyledonous leaf for photosynthesis. The first row has been completed for you.

Feature of leaf	Adaptation for photosynthesis
leaf mosaic	helps plant to absorb as much light as possible
large surface area of leaf lamina	
transparent upper epidermis	
waxy cuticle on upper epidermis	
stomata in lower epidermis	
air spaces in spongy mesophyll	

5 Copy and complete the table to show the adaptations of a palisade mesophyll cell for photosynthesis.

Feature of palisade mesophyll cell	Adaptation for photosynthesis
long cells arranged at right angles to the upper epidermis	
	large surface area of contact between cells and air
thin cell walls	
	chloroplasts are restricted to a layer near the outside of the cell where light can reach them

**6** Rearrange the following statements to make a flow diagram of the mechanism of opening a stoma.

1. volume of guard cell increases
2. H<sup>+</sup> transported out of guard cells
3. water enters guard cells by osmosis
4. K<sup>+</sup> diffuses into guard cells
5. guard cells curve to open stoma
6. water potential of guard cells falls
7. K<sup>+</sup> channels open

**7 a** Explain how the inner membrane system of a chloroplast makes it well adapted for photosynthesis.

**b** Copy the table below and insert ticks or crosses to show which structural features are shared by a plant chloroplast and a typical prokaryotic cell.

✓ = structural feature shared; ✗ = structural feature not shared.

Structural feature	Structural feature shared by chloroplast and typical prokaryotic cell
circular DNA	
DNA combined with structural protein to form chromosomes	
ribosomes about 18 nm in diameter	
complex arrangement of internal membranes	
peptidoglycan wall	
size ranges overlap	

**8 a** When isolated chloroplasts are placed in buffer solution with a blue dye such as DCPIP or methylene blue and illuminated, the blue colour disappears. Explain this observation.

[4]

**b** Name the compound, normally present in photosynthesis, that is replaced by the blue dye in this investigation. [1]

**[Total: 5]**

**9** Distinguish between:

- a** cyclic and non-cyclic photophosphorylation [2]
- b** photophosphorylation and oxidative phosphorylation [2]

c the roles of NAD and NADP in a plant.

[2]

[Total: 6]

**10 a** Draw a simple flow diagram of the Calvin cycle to show the relative positions in the cycle of the following molecules:

- CO<sub>2</sub> (1C)
- GP/PGA (3C)
- triose phosphate (3C)
- RuBP (5C).

[4]

**b** Show the point in the cycle at which the enzyme rubisco is active. [1]

[Total: 5]

**11 a** Explain what is meant by a limiting factor.

**b** List four factors that may be rate-limiting in photosynthesis.

**c** At

low light intensities, increasing the temperature has little effect on the rate of photosynthesis.

At

high light intensities, increasing the temperature increases the rate of photosynthesis.

Explain these observations.

[5]

[Total: 10]

**12 a** Distinguish between an absorption spectrum and an action spectrum. [4]

**b** Pondweed was exposed to each of three different wavelengths of light for the same length of time. For each wavelength, the number of bubbles produced from the cut ends of the pondweed were counted and are shown in the table.

wavelength of light / nm	mean number of bubbles produced in unit time
450	22
550	3
650	18

Explain these results.

[4]

[Total: 8]



**2. End-of-chapter answers**

1 B 2 C 3 A

4

Feature of leaf	Adaptation for photosynthesis
leaf mosaic	helps plant to absorb as much light as possible
large surface area of leaf lamina	helps plant to absorb as much light as possible
transparent upper epidermis	allows light to pass through epidermis to mesophyll cells
waxy cuticle on upper epidermis	prevents water loss from leaf as light heats it
stomata in lower epidermis	allows diffusion of carbon dioxide in and oxygen out of leaf when open, and can close to prevent water loss
air spaces in spongy mesophyll	large, moist surface area for gas exchange with mesophyll cells

5

Feature of palisade mesophyll cell	Adaptation for photosynthesis
long cells arranged at right angles to the upper epidermis	reduces number of cross walls that might absorb light
cylindrical cells with long air spaces between them	large surface area for contact between cells and air
thin cell walls	short diffusion path for carbon dioxide and oxygen
large vacuole surrounded by thin layer of cytoplasm	chloroplasts are restricted to a layer near the outside of the cell, where light can reach them

6 2, 7, 4, 6, 3, 1, 5

All correct = 4, subtract marks for mistakes.

**7 a** allows chlorophyll and other pigments to be arranged into photosystems;  
 provides large surface area for pigments;  
 increases efficiency of light harvesting; allows electron carriers to be arranged appropriately;  
 provides structure for proton gradient for chemiosmosis; anchors ATP synthase;

**b**

Structural feature	Structural feature shared by chloroplast and typical prokaryotic cell
circular DNA	✓
DNA combined with structural protein to form chromosomes	✗
ribosomes about 18 nm in diameter	✓
complex arrangement of internal membranes	✗
peptidoglycan wall	✗
size ranges overlap	✓

**8 a** photolysis of water occurs in light;  
 H<sup>+</sup> released; accepted by DCPIP/methylene blue;  
 colourless when reduced;  
 shows 'reducing power' of chloroplasts;

**[max. 4]****b** NADP;**[1]****[Total: 5]**

**9 a** cyclic photophosphorylation: electron emitted by chlorophyll of photosystem I returns to chlorophyll by a series of carriers;  
 non-cyclic photophosphorylation: electron emitted by chlorophyll of photosystem II does not return to that chlorophyll (but is absorbed by photosystem I and electron emitted by photosystem I is absorbed by NADP);

**[2]**

**b** photophosphorylation: synthesis of ATP using light energy in photosynthesis in a chloroplast; oxidative phosphorylation: synthesis of ATP using energy released from the electron transport chain in aerobic respiration in a mitochondrion;

**[2]**

**c** NAD: hydrogen carrier in respiration; NADP: hydrogen carrier in photosynthesis; **[2]**  
**[Total: 6]**

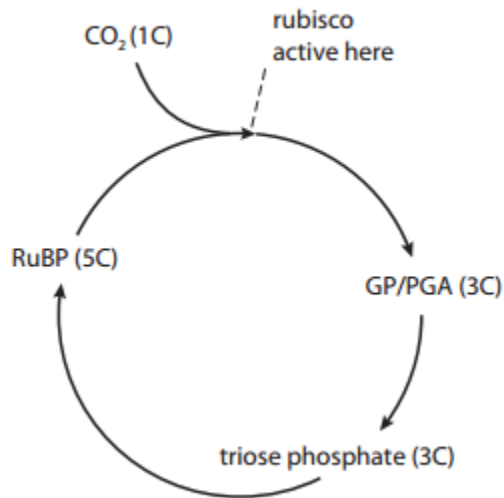
**10 a and b**

[Total: 5]

**11 a** limiting factor: one factor, of many affecting a process, that is nearest its lowest value and hence is rate-limiting; [1]

**b** light intensity; light wavelength; concentration of carbon dioxide; temperature; [4]

**c** shows that there are two sets of reaction in photosynthesis;

a light-dependent photochemical stage;

a light-independent temperature-dependent stage;

photochemical reactions are not affected by temperature; at low light intensities, light intensity is the rate-limiting factor;

at high light intensities and low temperatures, temperature is the rate-limiting factor; [max. 5]

[Total: 10]

**12 a** absorption spectrum: a graph of the absorbance of different wavelengths of light by a compound; action spectrum: a graph of the rate of a process, e.g. photosynthesis at different wavelengths of light; [4] b number of bubbles shows rate of photosynthesis; rate similar at 450 nm (blue) and 650 nm (red); these are wavelengths that are absorbed by chlorophyll; rate, much lower/refer to figures, at 550 nm (green); very little absorbed by any pigment; [max. 4]

[Total: 8]

## CHAPTER 16 – HOMEOSTASIS

### #90 Homeostasis in mammals

In the body of an animal conditions such as water concentration, temperature, and glucose concentration must be kept as constant as possible. Control systems that keep such conditions constant are examples of **homeostasis**; this is the maintenance of constant internal conditions in an organism.

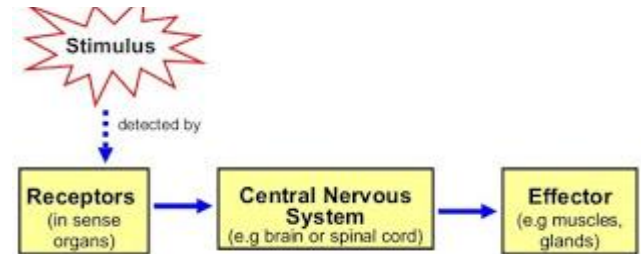

Some of the physiological factors controlled in homeostasis in mammals are:

- core body temperature
- metabolic wastes, particularly CO<sub>2</sub> and urea
- blood pH
- blood glucose concentration
- water potential of the blood
- the concentrations in the blood of the respiratory gases, O<sub>2</sub> and CO<sub>2</sub>.

### The importance of homeostasis

The **internal environment** of an organism = conditions inside the body in which the cells function. A cell's immediate environment is the tissue fluid that surrounds it. Many features of the tissue fluid influence how well the cell functions.

#### - Temperature:

- low temperatures slow down metabolic reactions;
- at high temperatures proteins, including enzymes, are denatured and cannot function

#### - Water potential:

- if the water potential decreases, water may move out of cells by osmosis, causing metabolic reactions in the cell to slow or stop;
- if the water potential increases, water may enter the cell causing it to swell and maybe burst

#### - Concentration of glucose

- glucose is the fuel for respiration, so lack of it causes respiration to slow or stop, depriving the cell of an energy source;
- too much glucose may cause water to move out of the cell by osmosis, again disturbing the metabolism of the cell.

In general, homeostatic mechanisms work by **controlling the composition of blood**, which therefore controls the composition of **tissue fluid**.

## Homeostatic control

Homeostatic control mechanisms have at least 3 interdependent components: **receptor**, **control center**, and **effector**.

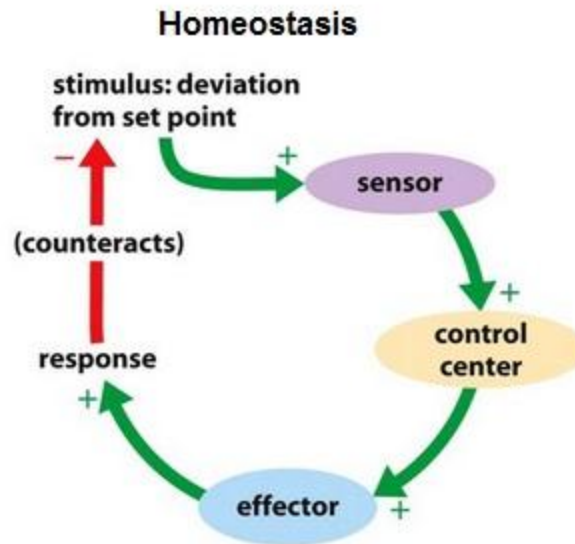

- The **receptor** senses environmental **stimuli** (external/internal), sending the information through the nervous system to a **control center** in the brain or spinal cord. This sensory information is known as the **input**.

- The **control center**, generally the brain, signals an **effector** (muscles and glands) to respond to the stimuli (to carry out an action, which is called the **output**). These actions are sometimes called **corrective actions** as their effect is to correct (or reverse) the change.

**Positive feedback** enhances or accelerates output created by an activated **stimulus** (any change in a factor, such as a change in bloodtemperature or the water content of the blood).

**Negative feedback** mechanisms consist of reducing the output or activity of any organ or system back to its normal range of functioning (e.g. adjusting blood pressure, metabolism, and body temperature).

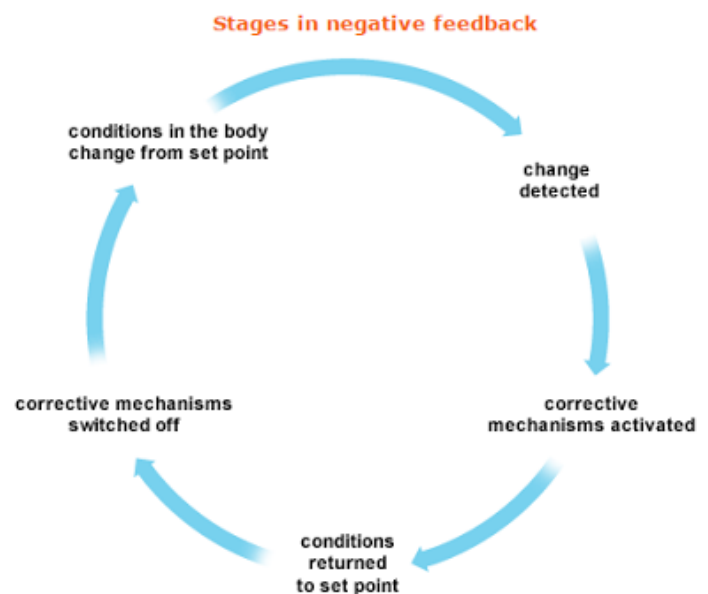

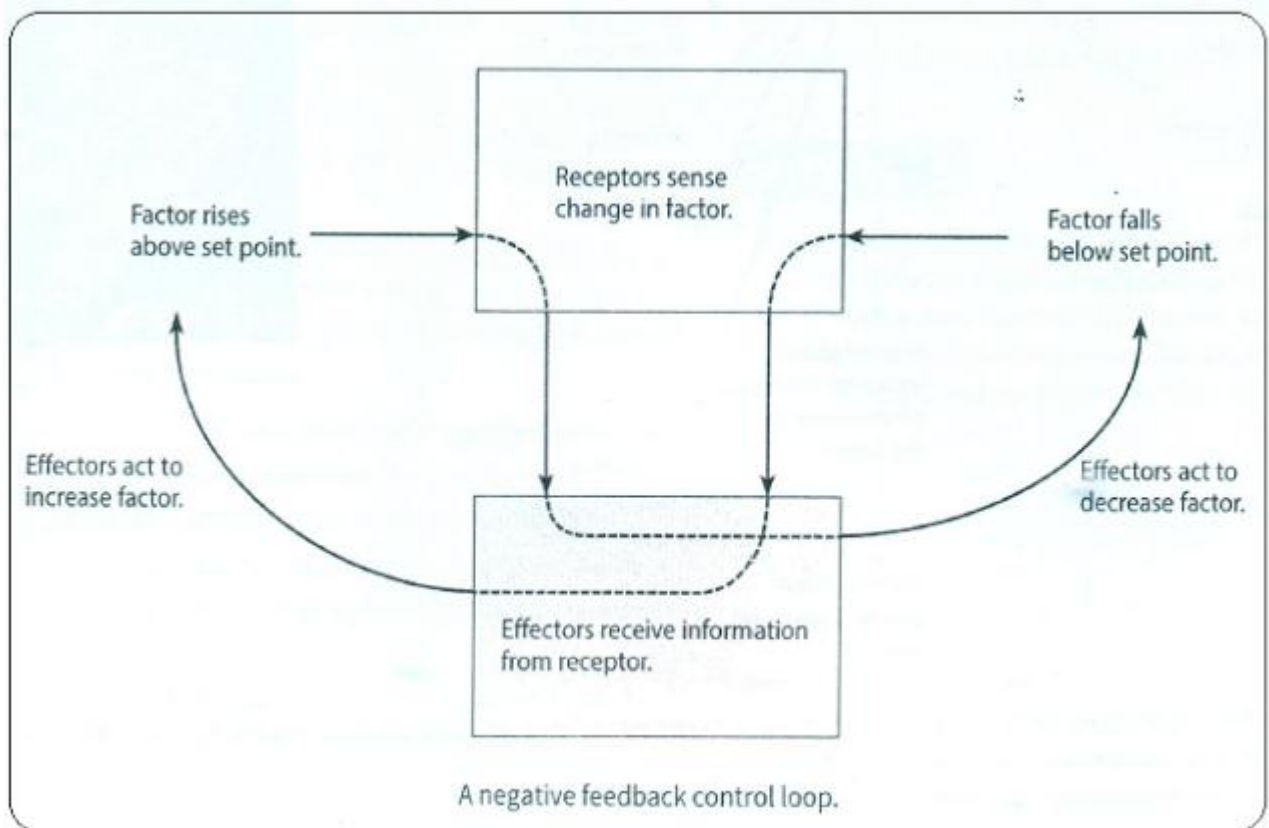
**VIDEO:****Feedback loops**

<https://www.youtube.com/watch?v=pR12XGWcn0U>

**Negative feedback control of temperature**

<https://www.youtube.com/watch?v=RgjKRJxvG-k>

**Negative Feedback Control of Blood Pressure**

<https://www.youtube.com/watch?v=YQMgV9pkwwA>

## #91 Thermoregulation - The control of body temperature

One of the most important examples of homeostasis is the **regulation of body temperature**. It involves both coordination systems - nervous and endocrine. Not all animals can do this physiologically.

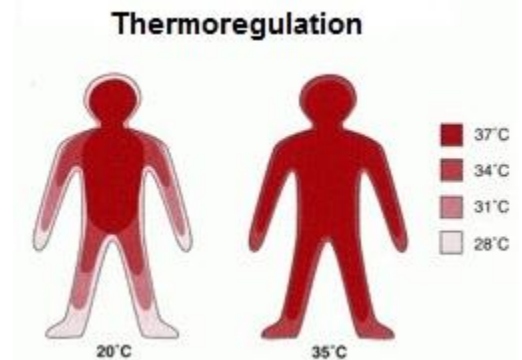

### Endotherms

- Animals (e.g. birds and mammals) that have a **constant** body temperature at around 35 - 40°C, also called **warm-blooded animals**.
- Use **internal corrective** mechanisms to maintain body temperature.

### Ectotherms

- Animals that have a **variable** body temperature.
- Use **behavioural** mechanisms (e.g. lying in the sun when cold, moving into shade when hot). Such mechanisms can be very effective, particularly when coupled with internal mechanisms to ensure that the temperature of the blood going to vital organs (brain, heart) is kept constant.

We use both!

### Thermoregulation

All mammals generate heat and have ways to retain it within their bodies. They also have physiological methods to balance heat gain, retention of body heat and heat loss so that they can maintain a constant body temperature. As a result, they are not dependent on absorbing heat from their surroundings and can be active at any time of day or night, whatever the external temperature. Most other animals (except birds) rely on external sources of heat and are often relatively inactive when it is cold.

The heat that mammals generate is released during **respiration**. Much of the heat is produced by liver cells that have a huge requirement for energy. The heat they produce is absorbed by the blood flowing through the liver and distributed around the rest of the body.

In humans, body temperature is controlled by the thermoregulatory centre in the **hypothalamus**. It receives input from 2 sets of **thermoreceptors**:

- Receptors **in the hypothalamus** monitor the temperature of the **blood** as it passes through the brain (the **core temperature**), that remains very close to the set point, which is 37 °C in humans. This temperature fluctuates a little, but is kept within very narrow limits by the hypothalamus.
- Receptors **in the skin** (especially on the **trunk**) monitor the **external temperature**.

Both sets of information are needed so that the body can make appropriate adjustments.

Our first response to encountering hotter or colder condition is **voluntary**:

- if too hot, we may decide to take some clothes off, or to move into the shade;
- if too cold, we put extra clothes on or turn the heating up!

It is only when these responses are not enough that the thermoregulatory centre is stimulated. This is part of the autonomic nervous system, so the various responses are all **involuntary**.

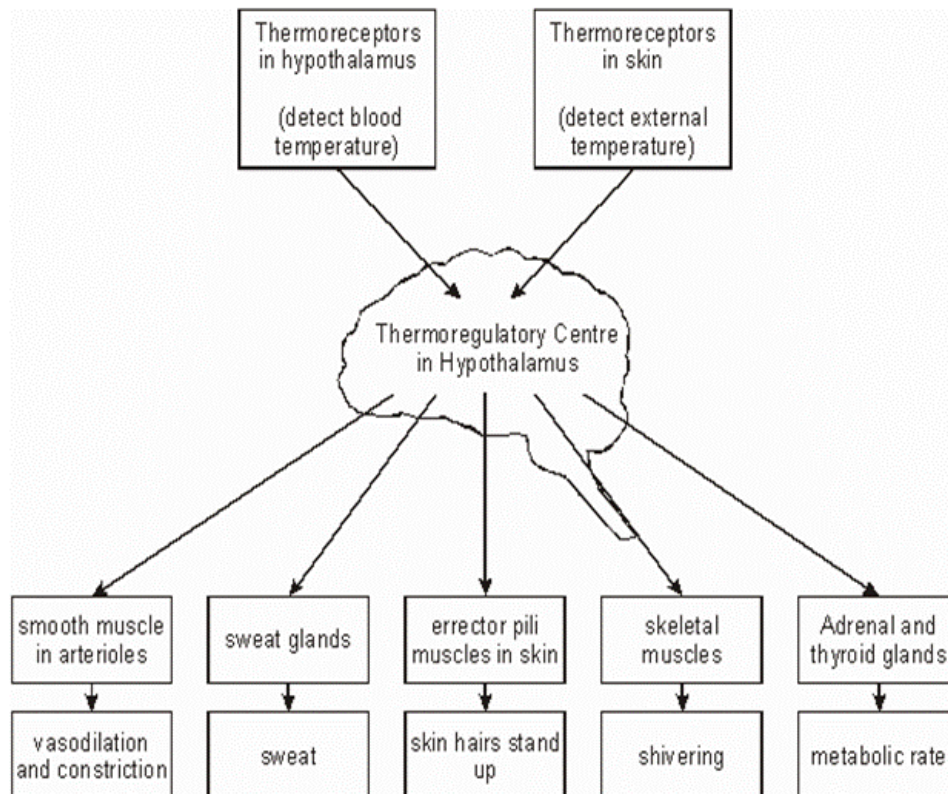

When we get too hot, the **heat loss centre** in the hypothalamus is stimulated; when we get too cold, it is the **heat conservation centre** of the hypothalamus which is stimulated.

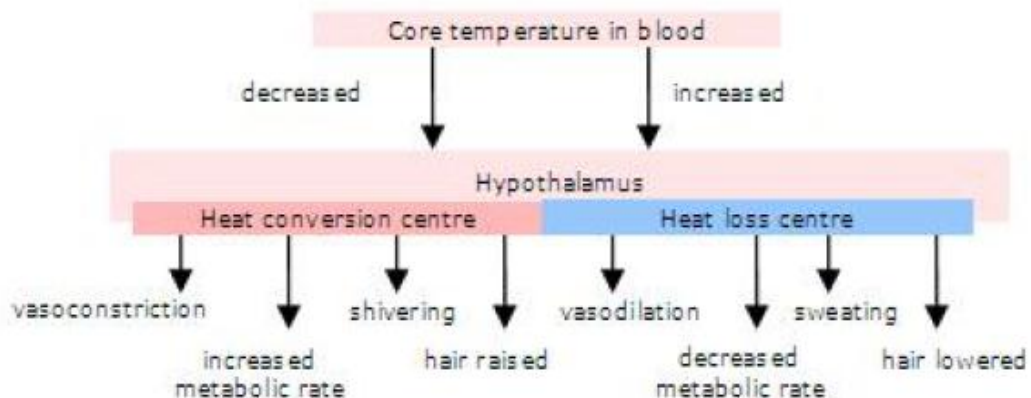



## Response to low temperature

If the core **temperature decreases**, or if the temperature receptors in the skin detect a decrease in the temperature of the surroundings, the hypothalamus sends impulses to several different effectors to adjust body temperature:

- **Vasoconstriction** - muscles in the walls of arterioles that supply blood to capillaries near the skin surface contract. This narrows the lumens of the arterioles and reduces the supply of blood to the capillaries so that less heat is lost from the blood.
- **Shivering** - the involuntary contraction of skeletal muscles generates heat which is absorbed by the blood and carried around the rest of the body.
- **Raising body hairs** - muscles at the base of hairs in the skin contract to increase the depth of fur so trapping air close to the skin. Air is a poor conductor of heat and therefore a good insulator. This is not much use in humans, but is highly effective for most mammals.
- **Decreasing the production of sweat** - this reduces the loss of heat by evaporation from the skin surface.
- Increasing the secretion of **adrenaline** - this hormone from the adrenal gland increases the rate of heat production in the liver.

## Response to high temperature

When an **increase** in environmental temperature is detected by skin receptors or the central thermoreceptors, the hypothalamus increases the loss of heat from the body and reduces heat production.

- **Vasodilation** - the muscles in the arterioles in the skin relax, allowing more blood to flow through the capillaries so that heat is lost to the surroundings.
- **Lowering body hairs** - muscles attached to the hairs relax so they lie flat, reducing the depth of fur and the layer of insulation.
- Increasing **sweat** production - sweat glands increase the production of sweat which evaporates on the surface of the skin so removing heat from the body.

### *Behavioural responses*

The behavioural responses of animals to heat include resting or lying down with the limbs spread out to increase the body surface exposed to the air. We respond by wearing loose fitting clothing, turning on fans or air conditioning and taking cold drinks.

When the environmental temperature decreases gradually:

- The hypothalamus releases a hormone which activates the anterior pituitary gland to release thyroid stimulating hormone (**TSH**).
- TSH stimulates the thyroid gland to secrete the hormone **thyroxine** into the blood.
- Thyroxine increases **metabolic rate**, which increases **heat production** especially in the liver.

When temperatures start to increase again, the hypothalamus responds by reducing the release of TSH by the anterior pituitary gland so less thyroxine is released from the thyroid gland.

Effector	Response to low temperature	Response to high temperature
Smooth muscles in peripheral arterioles in the skin.	<ul style="list-style-type: none"> <li>- Muscles contract causing <b>vasoconstriction</b>.</li> <li>- Less heat is carried from the core to the surface of the body, maintaining core temperature.</li> <li>- Extremities can turn blue and feel cold and can even be damaged (frostbite).</li> </ul>	<ul style="list-style-type: none"> <li>- Muscles relax causing <b>vasodilation</b>.</li> <li>- More heat is carried from the core to the surface, where it is lost by radiation.</li> <li>- Skin turns red.</li> </ul>
Sweat glands	No <b>sweat</b> produced.	<ul style="list-style-type: none"> <li>- Glands secrete sweat onto surface of skin, where it evaporates.</li> <li>- Water has a high latent heat of evaporation, so it takes heat from the body.</li> </ul>
Erector pili muscles in skin (attached to skin hairs)	<ul style="list-style-type: none"> <li>- Muscles contract, raising skin hairs and trapping an insulating layer of still, warm air next to the skin.</li> <li>- Not very effective in humans, just causing "goosebumps".</li> </ul>	<ul style="list-style-type: none"> <li>- Muscles relax, lowering the skin hairs and allowing air to circulate over the skin, encouraging convection and evaporation.</li> </ul>
Skeletal muscles	Muscles contract and relax repeatedly, generating heat by friction and from metabolic reactions.	No shivering.
Adrenal and thyroid glands	Glands secrete adrenaline and thyroxine respectively, which increase the metabolic rate in different tissues, especially the liver, so generating heat.	Glands stop releasing adrenaline and thyroxine.
Behaviour	Curling up, huddling, finding shelter, putting on more clothes.	Stretching out, finding shade, swimming, removing clothes.

## VIDEO

### Controlling body temperature

[https://www.youtube.com/watch?v=Vlp\\_NHuC0rw](https://www.youtube.com/watch?v=Vlp_NHuC0rw)

Homeostasis <https://www.youtube.com/watch?v=e4YbdGBvFAE>

## #92 Excretion and structure of Kidneys

The kidneys remove wastes from the blood and are the effectors for controlling the **water potential** of the blood. The removal of waste products generated by metabolic reactions inside body cells is called **Excretion**. Some of these products are toxic, while others are simply in excess of requirements.

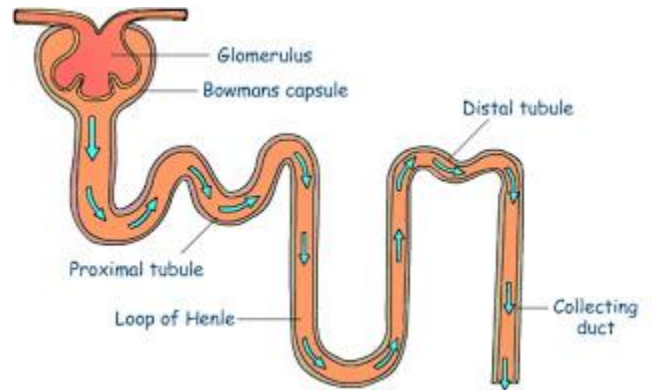

In mammals, the 2 major excretory products are:

- **CO<sub>2</sub>** produced by aerobic respiration. CO<sub>2</sub> dissolves in H<sub>2</sub>O to produce a weak acid, so if too much builds up in body fluids the pH drops, which can damage cells and disrupt metabolism. CO<sub>2</sub> is transported to the lungs dissolved in blood plasma and excreted in expired air.
- **Nitrogenous excretory products**, in particular **urea**. Excess amino acids cannot be stored in the body. In the liver, they are converted to urea, CO(NH<sub>2</sub>)<sub>2</sub>, and a **keto acid**. The keto acid can be respired to provide energy, or converted to fat for storage. The urea dissolves in the blood plasma and is removed and excreted by the kidneys.

### The structure and histology of kidneys

Each kidney is supplied with oxygenated blood through a **renal artery**. Blood is removed in the **renal vein**. A tube called the **ureter** takes urine from the kidney to the bladder.

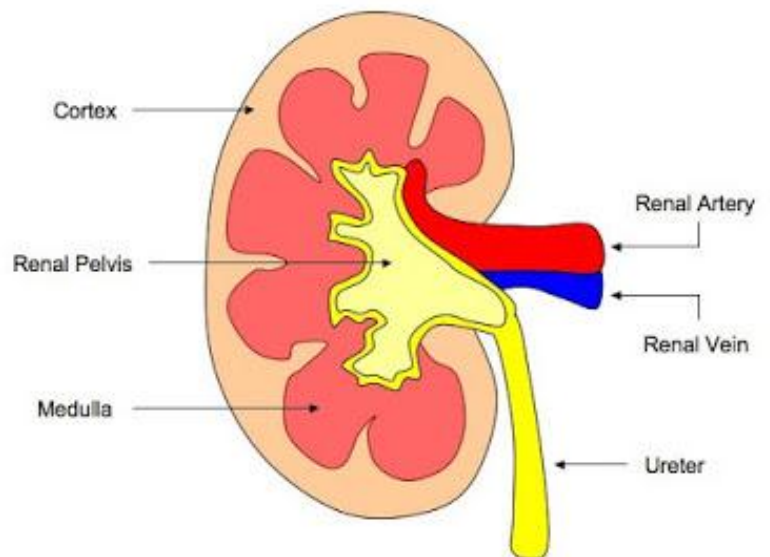

Each kidney contains thousands of microscopic tubes called **nephrons**. The beginning of each nephron is a cup-shaped structure called a **renal capsule** (Bowman's capsule). This is in the **cortex** of the kidney. The tube leads from the renal capsule

down into the kidney **medulla**, then loops back into the cortex before finally running back down through the medulla into the **pelvis** of the kidney, where it joins the **ureter**.

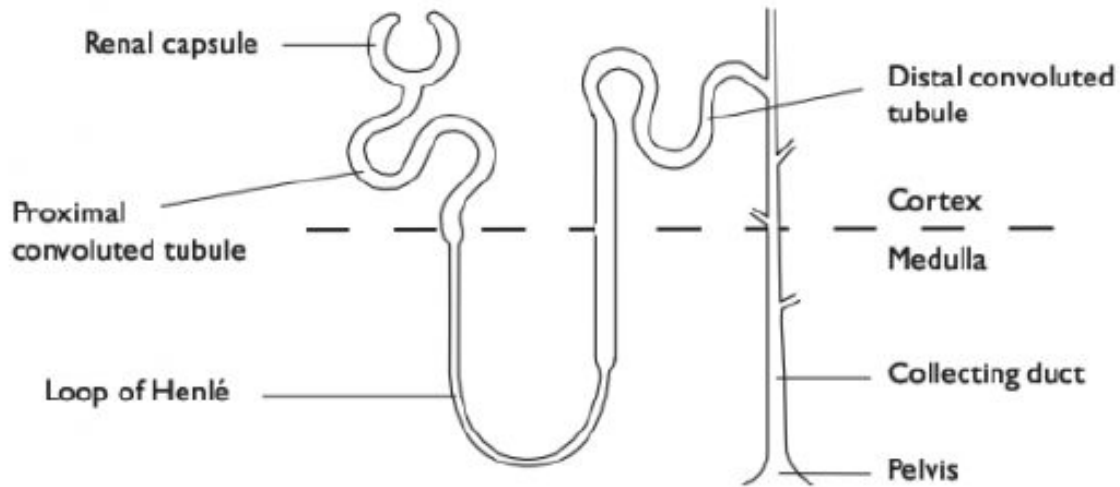

**Structure of a nephron**

Each nephron has a network of blood vessels associated with it. Blood arrives in the **afferent arteriole** (from the renal artery), and is delivered to a network of capillaries, called a **glomerulus**, in the cup of the renal capsule. Blood leaves the glomerulus in the **efferent arteriole**, which is narrower than the afferent arteriole. This leads to another network of capillaries that wraps around the nephron, before delivering the blood to a branch of the **renal vein**.

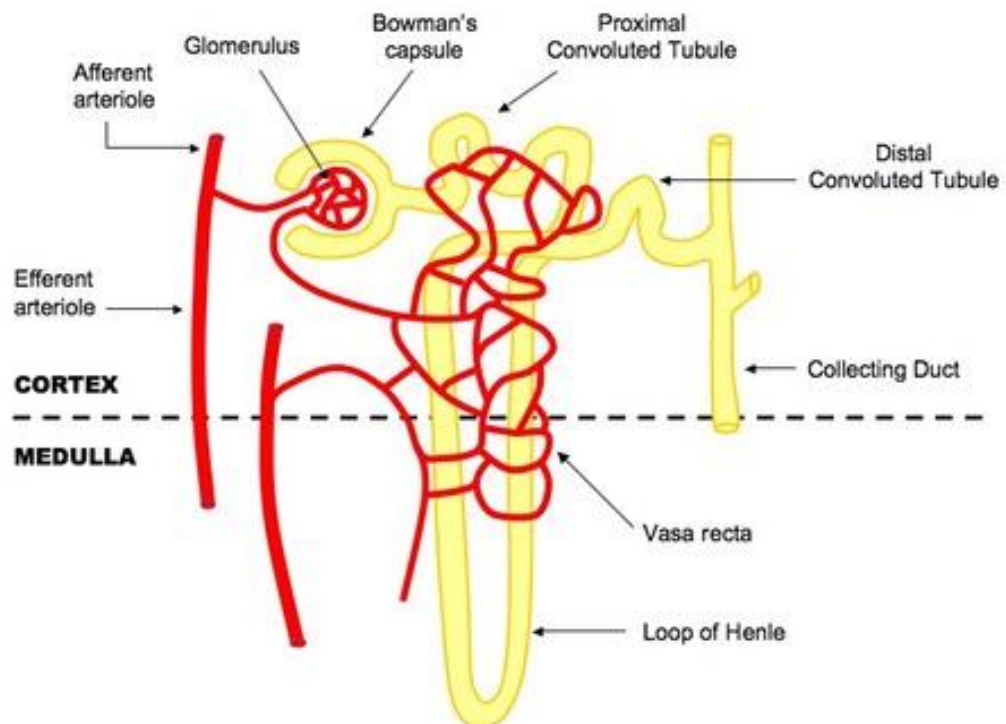

The diagrams below show the **histology** (structure of tissues) of the kidney.

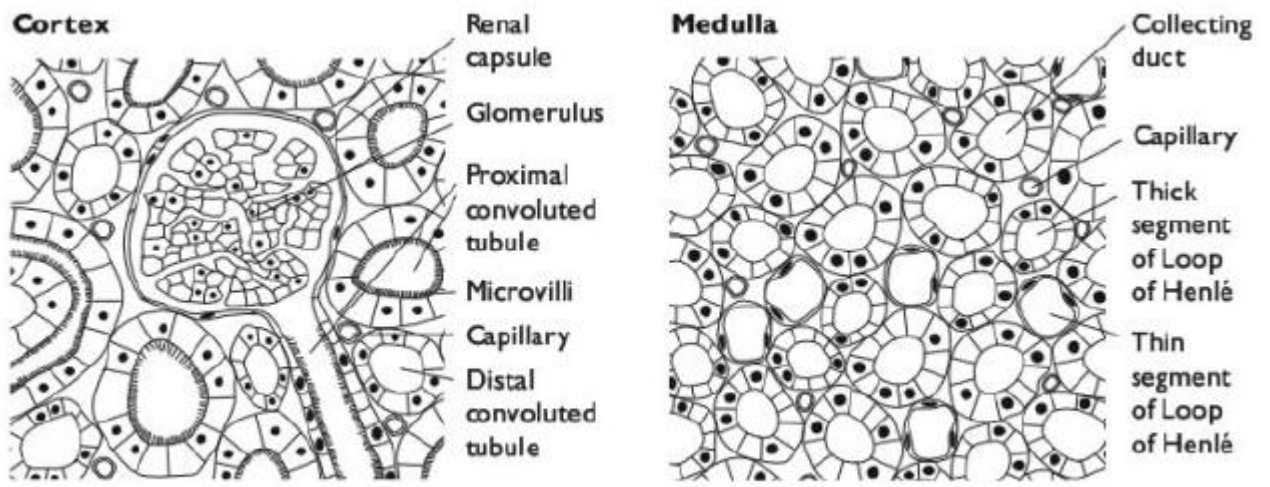

***Histology of the kidney***

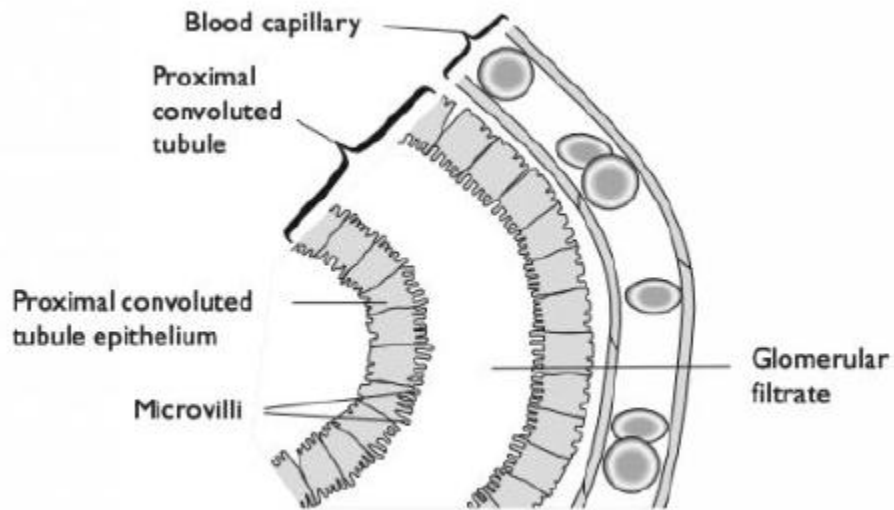

***Longitudinal section of part of a proximal convoluted tubule***

## #93 Production of urine in a nephron - Ultrafiltration and reabsorption

**Ultrafiltration** occurs at the barrier between the **blood** and the **filtrate** in the renal capsule or Bowman's capsule in the kidneys.

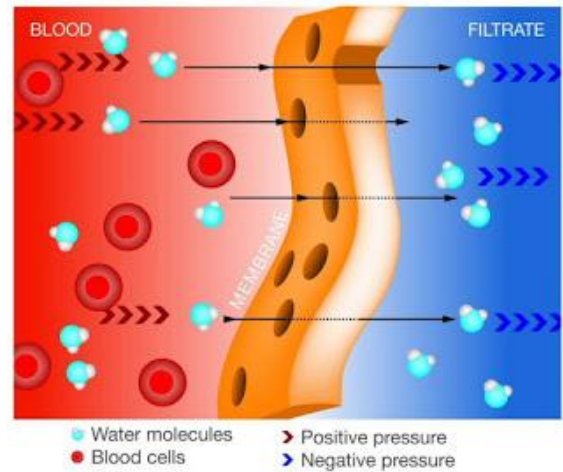

### Ultrafiltration

The Bowman's capsule contains a dense capillary network called the **glomerulus**. Blood flows into these capillaries through the **afferent arteriole** and leaves through the **efferent arteriole**.

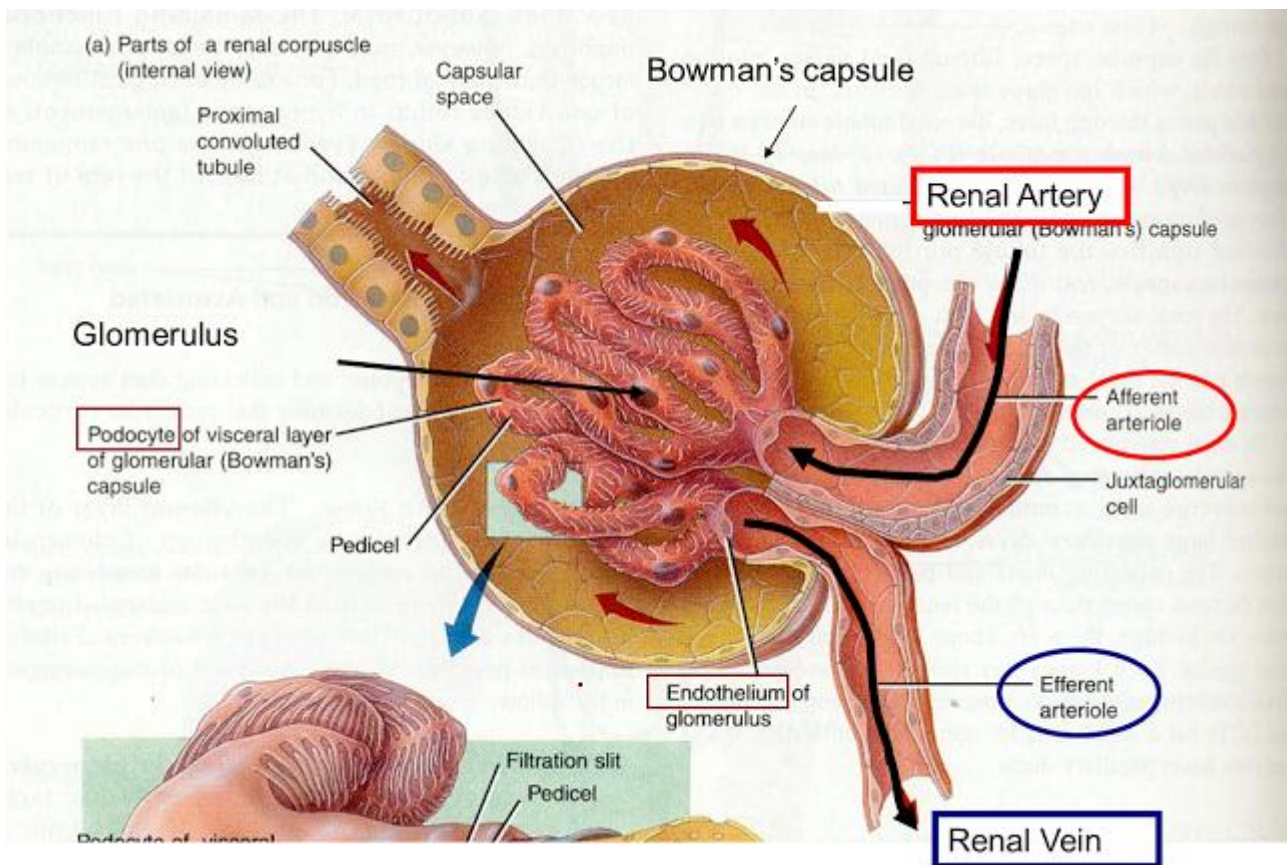

The blood in a glomerulus is separated from the space inside the renal capsule by:

- the capillary wall (**endothelium**) which is one cell thick and has pores in it;
- the **basement membrane** of the wall of the renal capsule;
- the layer of cells making up the wall of the renal capsule, called **podocytes**; these cells have slits between them.

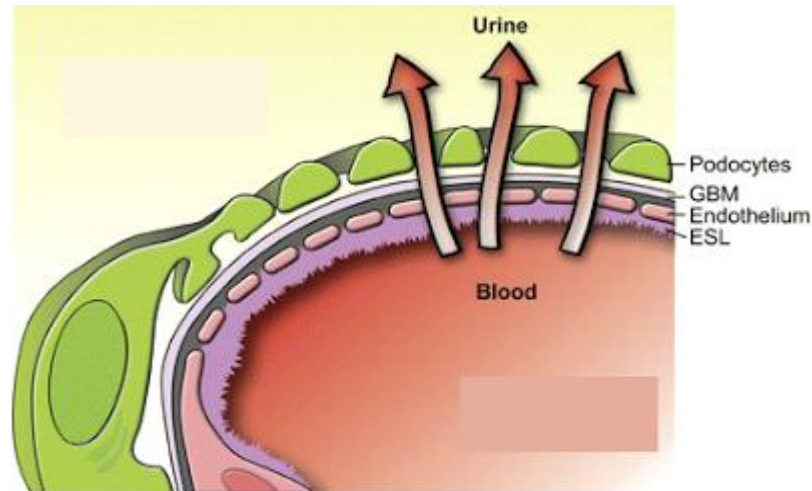

The blood in a glomerulus is at a relatively **high pressure**, because the efferent arteriole is narrower than the afferent arteriole. This forces molecules from the blood through these three structures, into the renal capsule.

The pores in the capsular endothelium and the slits between the podocytes will let all molecules through, but the basement membrane acts as a filter and will only let small molecules pass through.

- Substances that can pass through include water, glucose, inorganic ions such as  $\text{Na}^+$ ,  $\text{K}^+$  and  $\text{Cl}^-$  and urea.
- Substances that cannot pass through include red and white blood cells and plasma proteins (such as albumen and fibrinogen).
- The liquid that seeps through into the renal capsule is called glomerular filtrate.

**Comparison of the composition of blood and glomerular filtrate**

Component	Blood	Glomerular filtrate
Cells	Contains red cells, white cells and platelets	No cells
Water/gdm <sup>-3</sup>	900	900
Inorganic ions (including Na <sup>+</sup> , K <sup>+</sup> and Cl <sup>-</sup> )/gdm <sup>-3</sup>	7	7
Plasma proteins/gdm <sup>-3</sup>	45	0
Glucose/gdm <sup>-3</sup>	1	1
Urea/gdm <sup>-3</sup>	0.3	0.3

**Selective reabsorption in the proximal convoluted tubule**

Some of the substances that are filtered into the renal capsule need to be retained by the body. These include:

- much of the **water**
- all of the **glucose**
- some of the **inorganic ions**

These substances are therefore taken back into the blood through the walls of the proximal convoluted tubule. This is called **selective reabsorption**.

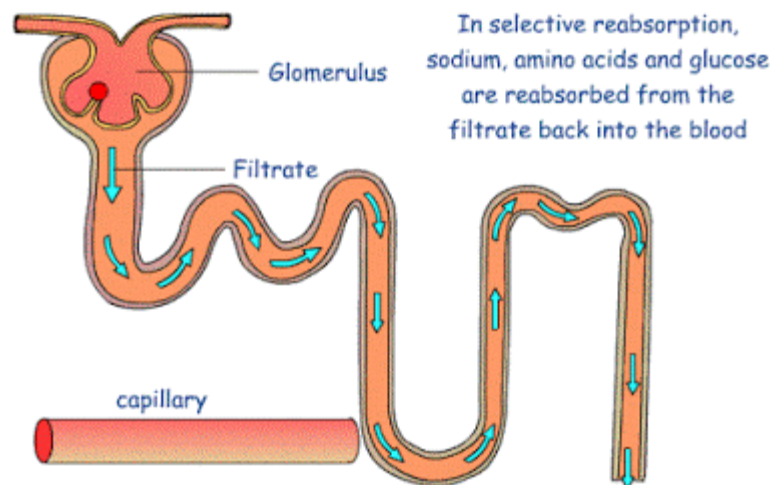

The cells in the walls of the tubule have many mitochondria, to provide ATP for active transport. Their surfaces facing the lumen of the tubule have a large surface area provided by microvilli.

- **Active transport** is used to move **Na<sup>+</sup>** out of the outer surface of a cell in the wall of the proximal convoluted tubule, into the blood.



- This lowers the concentration of  $\text{Na}^+$  inside the cell, so that  $\text{Na}^+$  ions diffuse into the cell from the fluid inside the tubule. The  $\text{Na}^+$  ions diffuse through protein transporters in the cell surface membrane of the cell
- As the  $\text{Na}^+$  ions diffuse through these transporter proteins, they carry **glucose** molecules with them. This is called **co-transport**. The glucose molecules move through the cell and diffuse into the blood.
- The movement of  $\text{Na}^+$  and glucose into the blood decreases the water potential in the blood. **Water** therefore moves by osmosis from the fluid inside the tubule, down a water potential gradient through the cells making up the wall of the tubule and into the blood.

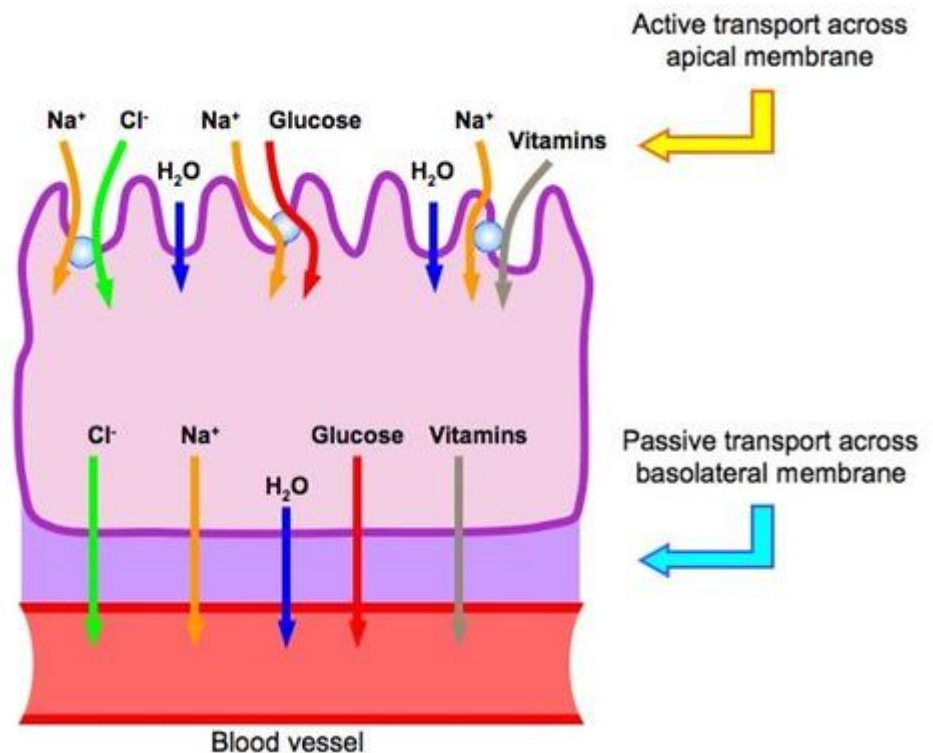

As a result, the fluid inside the nephron now has:

- no glucose
- a lower concentration of  $\text{Na}^+$  than the filtrate originally had
- less water than the filtrate originally had

About 50% of the urea is also reabsorbed in the proximal convoluted tubule.

### The loop of Henle

Some, but not all, nephrons have long loops of Henle that dip down into the medulla and then back up into the cortex. The function of the loop of Henle is to build up a high concentration of  $\text{Na}^+$  and  $\text{Cl}^-$  in the tissues of the medulla. This allows highly concentrated urine to be produced. Note that the loop of Henle itself does not produce highly concentrated urine.

As fluid flows down the descending limb of the loop of Henle, water moves out of it by osmosis. By the time the fluid reaches the bottom of the loop, it has a much lower water potential than at the top of the loop. As it flows up the ascending limb,  $\text{Na}^+$  and  $\text{Cl}^-$  move out of the fluid into the surrounding tissues, first by diffusion and then by active transport.

This creates a low water potential in the tissues of the medulla. The longer the loop, the lower the water potential that can be produced.

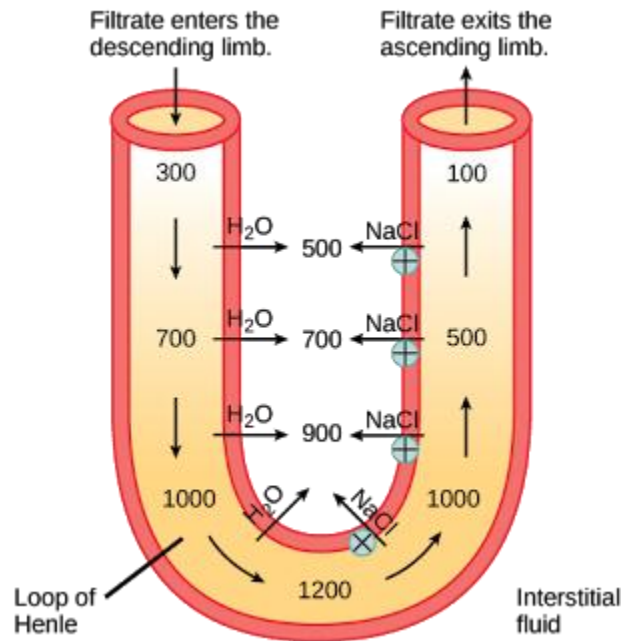

### *Role of loop of Henle*

- Creating a Salt Gradient in the Medulla
- The function of the loop of Henle is to create a salt bath concentration in the fluid surrounding the tubule
- The descending limb of the loop of Henle is permeable to water, but relatively impermeable to  $\text{Na}^+\text{Cl}^-$ .
- The ascending limb of the loop of Henle is permeable to salts, but impermeable to water
- This means that as the loop descends into the medulla, the interstitial fluid becomes more salty (and less salty as it ascends into the cortex)
- As the vasa recta blood network that surrounds the loop flows in the opposite direction (counter-current exchange), this further multiplies the effect.

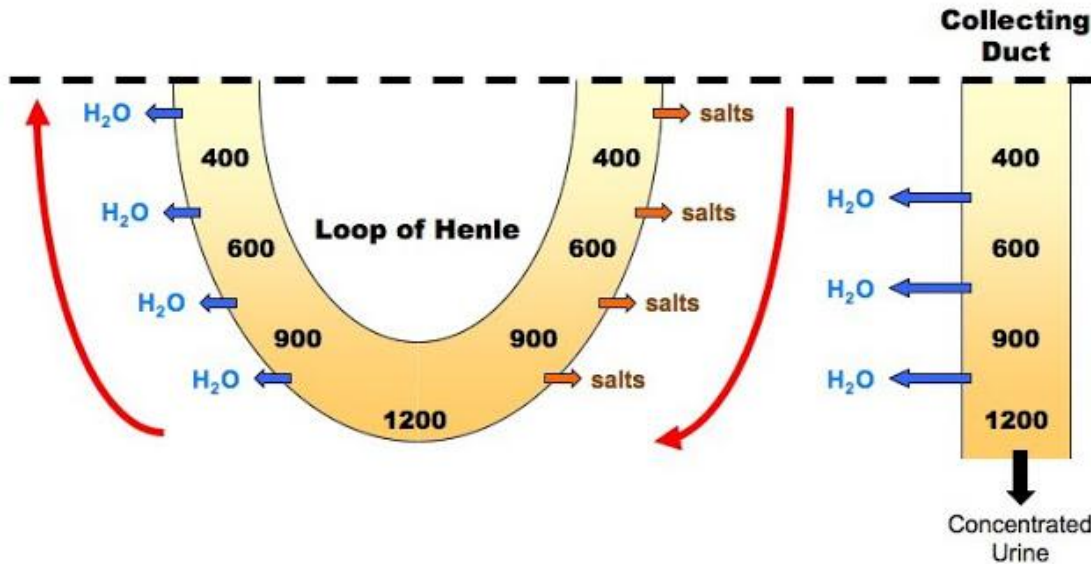

### The distal convoluted tubule and collecting duct

The fluid inside the tubule as it leaves the loop of Henle and moves into the collecting duct has lost a little more water and more  $Na^+$  than it had when it entered the loop. Because more water has been lost, the concentration of urea has increased.

Now, in the distal convoluted tubule,  $Na^+$  is actively transported out of the fluid.

The fluid then flows through the collecting duct. This passes through the medulla, where you have seen that a low water potential has been produced by the loop of Henle. As the fluid continues to flow through the collecting duct, **water** moves down the water potential gradient from the collecting duct and into the tissues of the medulla. This further increases the concentration of urea in the tubule. The fluid that finally leaves the collecting duct and flows into the ureter is urine.

## Nephron-tubular system

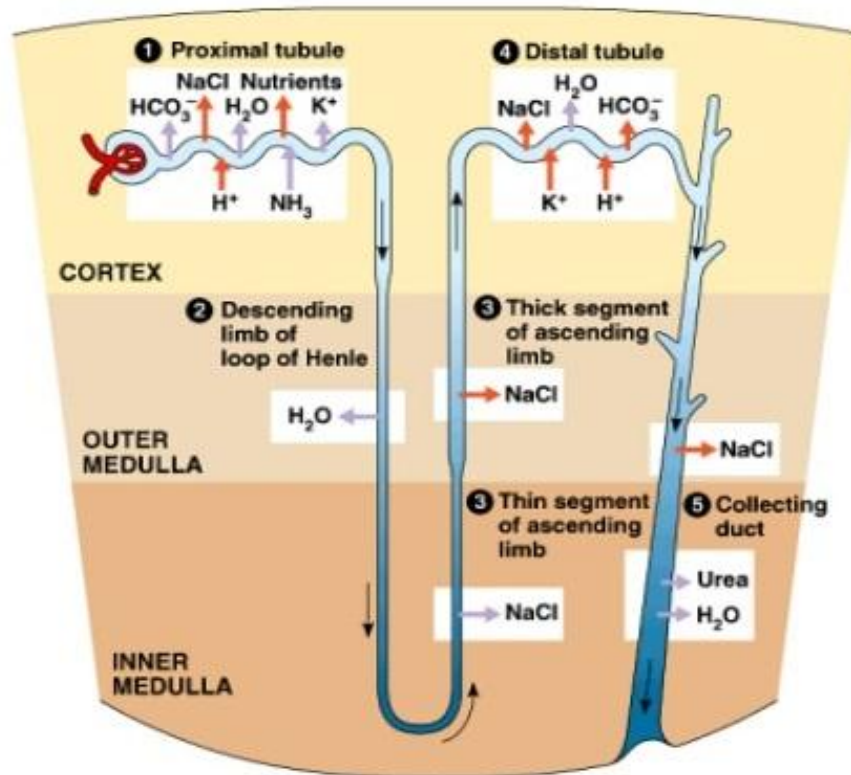

1. Proximal convoluted tubule
2. Descending loop of Henle
3. Ascending loop of Henle
4. Distal convoluted tubule
5. Collecting duct

## VIDEO

### Homeostasis in humans

<https://www.youtube.com/watch?v=4WN-cOEdF6I>

## #94 Osmoregulation

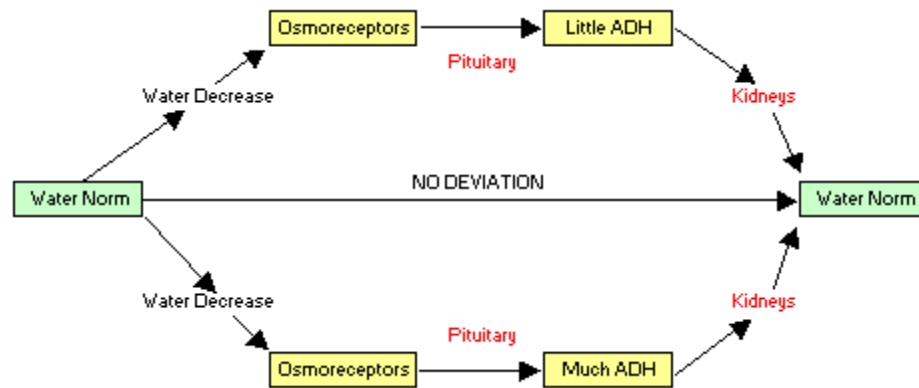

**Osmoregulation** is the control of the water content of body fluids. It is part of homeostasis, the maintenance of a constant internal environment.

It is important that cells are surrounded by tissue fluid of a similar water potential to their own contents, to avoid too much water loss or gain which could disrupt metabolism. You have seen that water is lost from the fluid inside a nephron as it flows through the collecting duct. The permeability of the walls of the distal convoluted tubule and collecting duct can be varied.

- If they are permeable, then much water can move out of the tubule and the urine becomes concentrated. The water is taken back into the blood and retained in the body.
- If they are made impermeable, little water can move out of the tubule and the urine remains dilute. A lot of water is removed from the body.

### ADH

ADH is **antidiuretic hormone**. It is secreted from the **anterior pituitary gland** into the blood.

When the water potential of the blood is too low (that is, it has too little water in it), this is sensed by **osmoreceptor cells** in the **hypothalamus**. The osmoreceptor cells are neurones (nerve cells). They produce ADH, which moves along their axons and into the anterior pituitary gland from where it is secreted into the blood.

The ADH travels in solution in the blood plasma. When it reaches the walls of the collecting duct, it makes them permeable to water. Water is therefore reabsorbed from the fluid in the collecting duct and small volumes of concentrated urine are produced.

When the water potential of the blood is too high (that is, it has too much water in it), this is sensed by the osmoreceptor cells and less ADH is secreted. The collecting duct walls therefore become less permeable to water and less is reabsorbed into the blood. Large volumes of dilute urine are produced.

### Negative feedback

The mechanism for controlling the water content of the body, using ADH, is an example of negative feedback.

When the water potential of the blood rises too high or falls too low, this is sensed by receptor cells. They cause an action to be taken by effectors which cause the water potential to be moved back towards the correct value.

In this case, the receptors are the osmoreceptor cells in the hypothalamus, and the effectors are their endings in the anterior pituitary gland that secrete ADH.

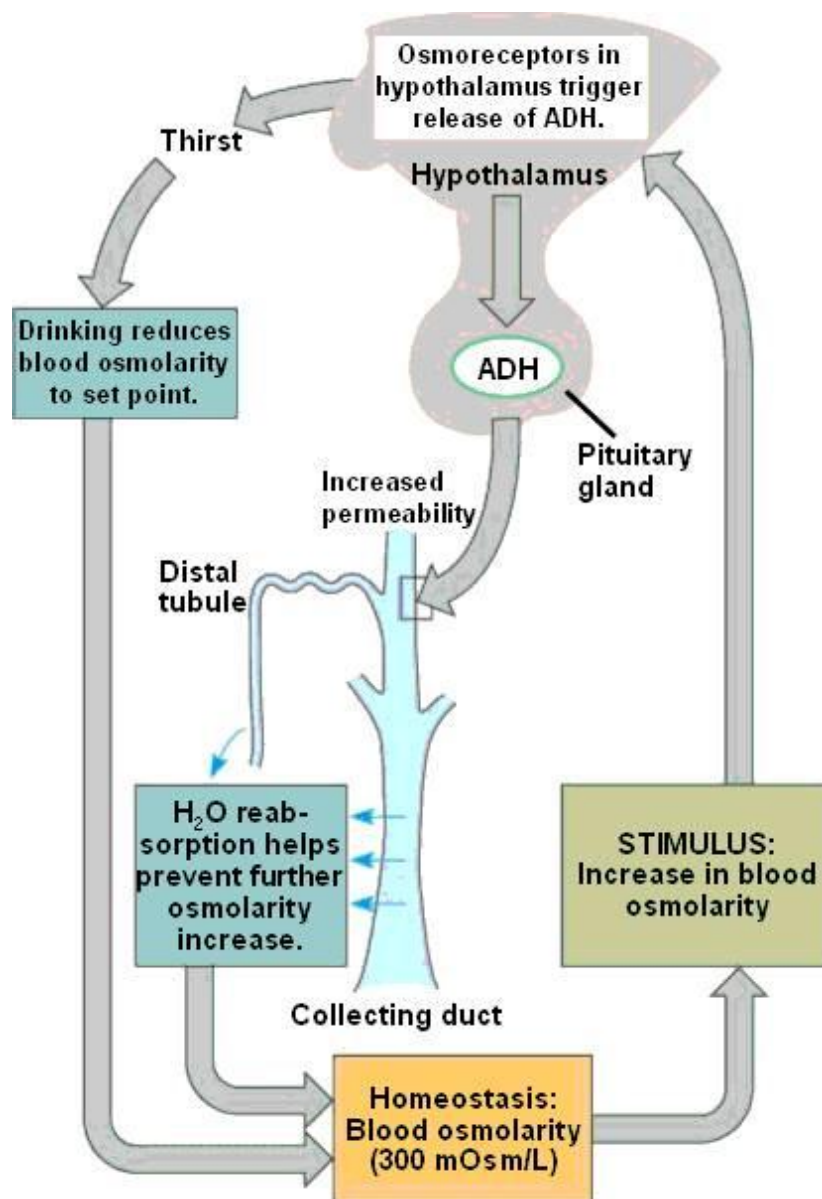

## #95 The control of blood glucose

The blood glucose concentration is regulated by negative feedback control mechanisms.

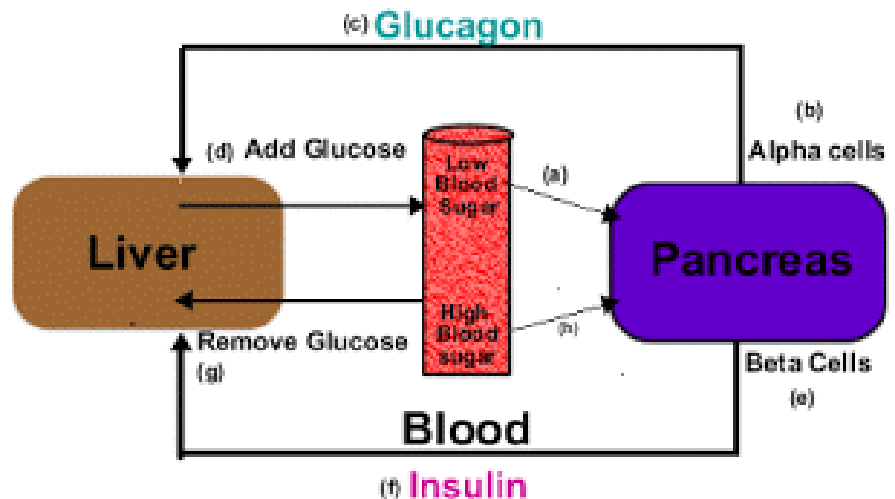

Blood glucose concentration should remain at a fairly constant value of about 100 mg glucose per 100 cm<sup>3</sup> of blood.

- If blood glucose concentration **falls** well below this level, the person is said to be **hypoglycaemic**. Cells do not have enough glucose to carry out respiration, and so metabolic reactions may not be able to take place and the cells cannot function normally. This is especially so for cells such as brain cells, which can only use glucose and not other respiratory substrates. The person may become unconscious and various tissues can be damaged.
- If blood glucose concentration **rises** well above this level, the person is said to be **hyperglycaemic**. The high glucose concentration decreases the water potential of the blood and tissue fluid, so that water moves out of cells down a water potential gradient. Again, unconsciousness can result.

Several hormones are involved in the control of blood glucose concentration by **negative feedback**. They include **insulin** and **glucagon**.

Both of these are small proteins. They are secreted by patches of tissue called **islets of Langerhans** in the pancreas. Insulin is secreted by  $\beta$  cells. Glucagon is secreted by  $\alpha$  cells.

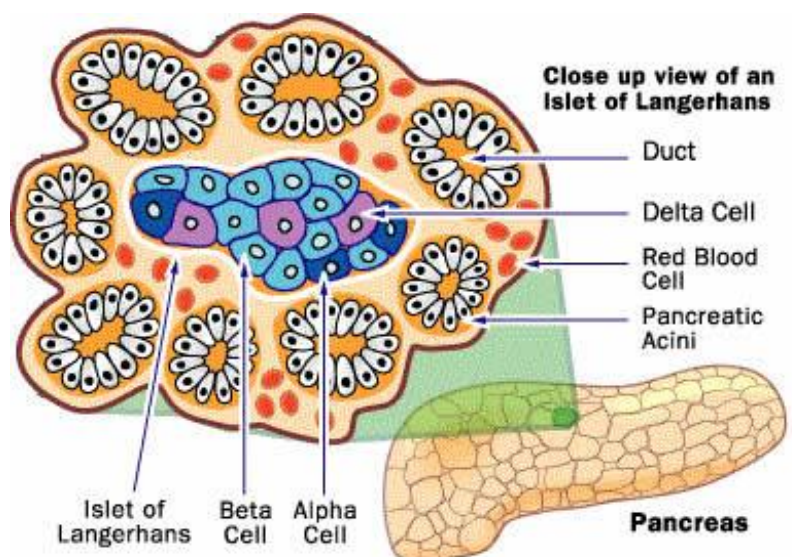

When blood glucose concentration **rises too high**, this is sensed by the  **$\beta$  cells**. They respond by secreting greater quantities of insulin into the blood. The insulin has several effects, including:

- causing muscle and adipose tissue cells (fat cells) to absorb more glucose from the blood;
- causing liver cells to convert glucose to glycogen for storage.
- These effects cause the blood glucose concentration to fall.

When blood glucose concentration **falls too low**, this is sensed by the  **$\alpha$  cells**. They respond by secreting greater quantities of glucagon into the blood. This has several effects, including:

- causing liver cells to break down glycogen to glucose, and releasing it into the blood;
- causing liver cells to produce glucose from other substances such as amino acids or lipids.

These effects cause blood glucose concentration to rise.

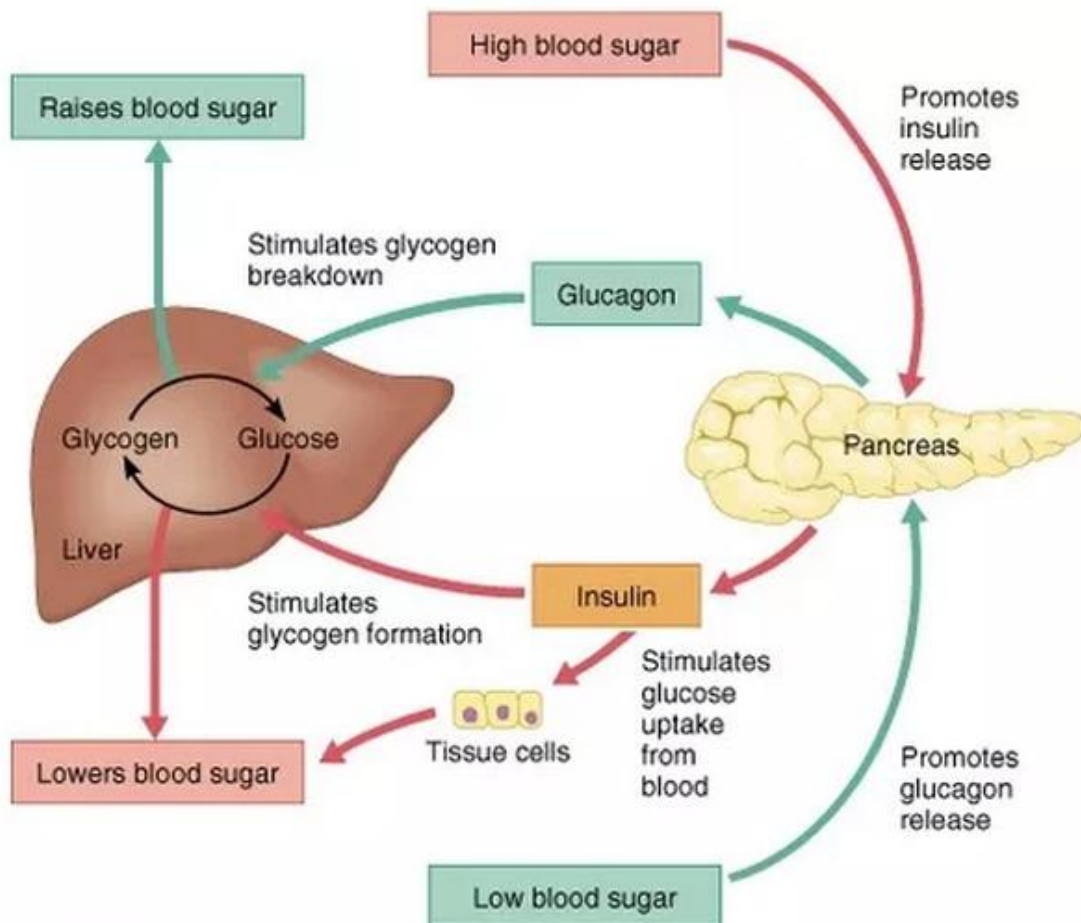

Copyright © 2001 Benjamin Cummings, an imprint of Addison Wesley Longman, Inc.

### Summary:

After eating a meal, blood glucose rises:

- Food eg. starch are hydrolyzed by digestive enzymes into glucose
- Glucose is absorbed across the gut wall into the blood capillaries
- Rise in blood glucose detected by  $\beta$ -cells of islets of langerhans in the pancreas



- Insulin is secreted into the bloodstream
- Promotes the uptake of glucose by the liver and muscle cells
- Glucose then converted to glycogen

During exercise, blood glucose concentration falls:

- Detected by  $\alpha$ - and  $\beta$ -cells of islets of langerhans in the pancreas
- Fall inhibits further insulin secretion
- Secretion of glucagons by  $\alpha$ -cells into the blood
- Binds to receptors on liver cell surface membrane
- Activation of phosphorylase
- Promotes conversion of glycogen to glucose in the liver (glycogenolysis)
- Promotes gluconeogenesis, the production of glucose
- Glucose is released into the bloodstream
- Fats are broken down and respired.

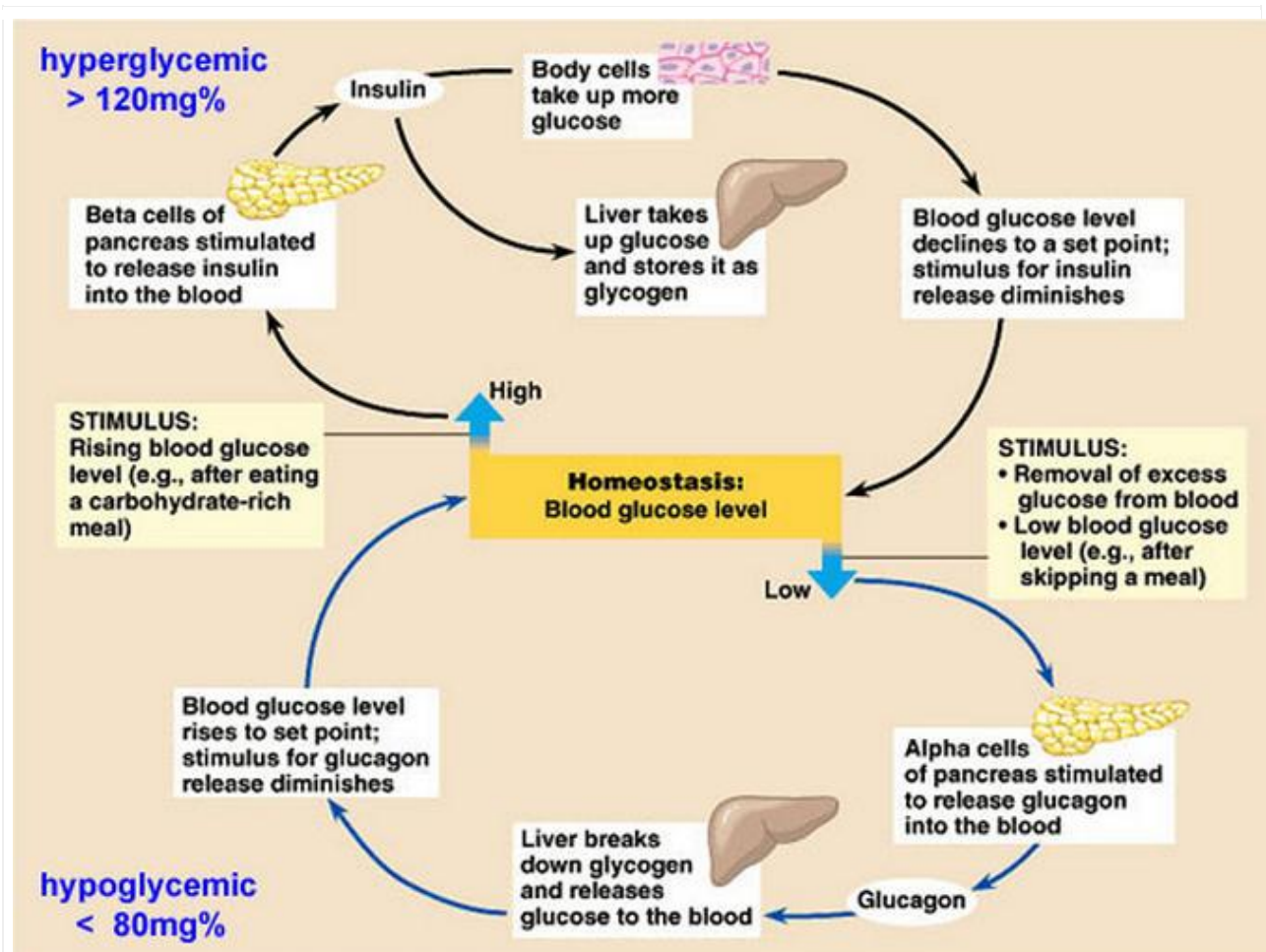

Source: Pearson Education.

#### VIDEO Insulin and Glucagon:

<https://www.youtube.com/watch?v=e-3N7w2sWps>

#### Insulin and Regulation of Glucose in the Blood:

<https://www.youtube.com/watch?v=OIHez8gwMqw>

## #96 Control of blood glucose - glucagon

Insulin and glucagon work together as part of a **negative feedback** system. As a result of glucagon secretion, the **liver releases extra glucose** to increase the concentration in the blood. Muscle cells do not have receptors for glucagon and so do not respond to it.

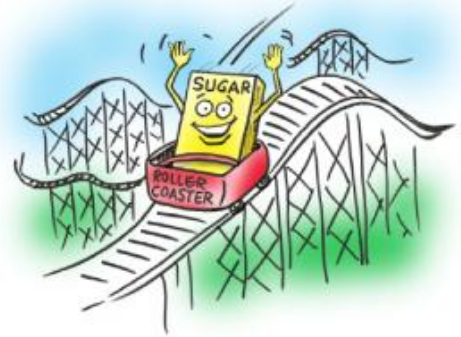

This is question 9, taken directly from the specimen paper for summer 2016 so you won't have to worry about the phrasing :) It is for glucagon but will work fine with adrenaline.

(the numbers marked are according to the mark scheme and not the diagram below)

1. glucagon binds to **receptors** in cell surface membrane (of liver cell)
2. receptor changes conformation
3. **G-protein** activated
4. adenylate cyclase activated
5. ATP converted to **cyclic AMP**
6. (cyclic AMP is) second messenger
7. (cyclic AMP) activates **kinase protein**
8. **enzyme cascade**: amplifies original signal of glucagon
9. ref. phosphorylase enzyme(s) / glycogen phosphorylase
10. **glycogen broken to glucose**
11. glucose, diffuses / passes out, of (liver) cell (into the blood)
12. through GLUT2 transporter proteins
13. AVP ; e.g. ref. to stimulating **gluconeogenesis**

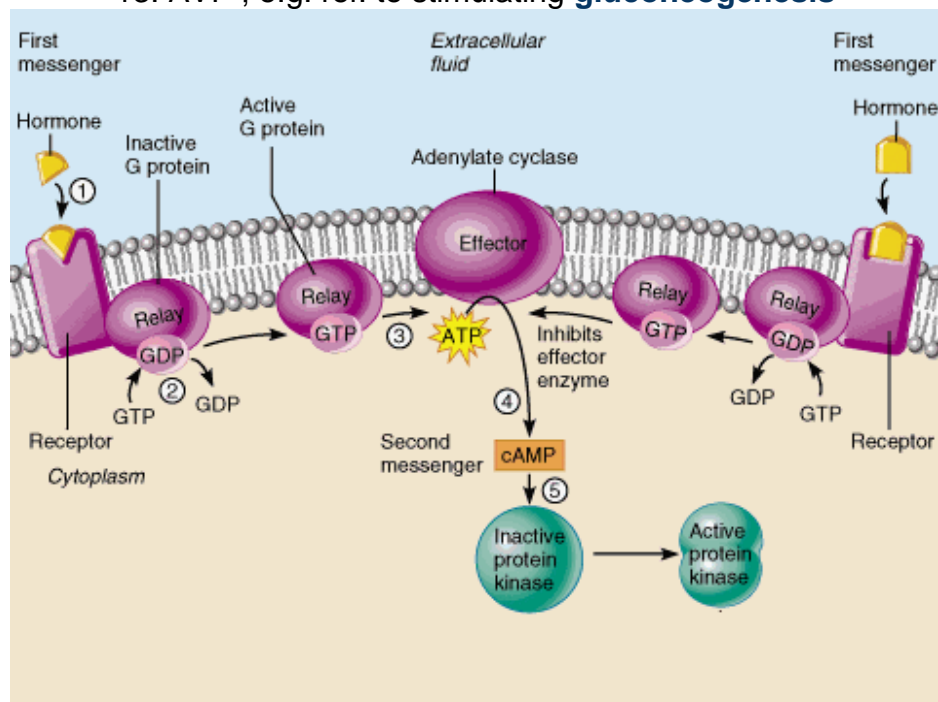

## #97 Urine analysis, dipsticks and biosensors

The presence of **glucose** and **ketones** in urine indicates that a person may have **diabetes**. If the concentration for these rises above the **renal threshold**, then not all glucose has been absorbed from the filtrate in the proximal convoluted tubule --> so will be present in the urine.



A large quantity or long-term presence of protein in the urine indicates

- disease affecting glomeruli
- kidney infection
- high blood pressure (can lead to heart disease)

### 1. Dip sticks: test for glucose, pH, ketones, proteins

- urine analysis
- involves 2 immobilized enzymes: **glucose oxidase** and **peroxidase**
- shows the sugar level **in urine** from bladder NOT the current blood sugar level

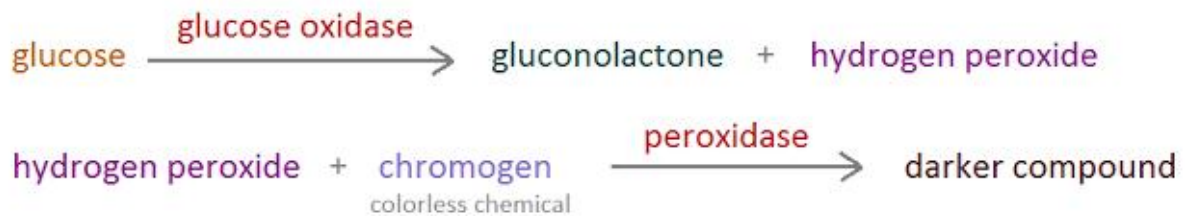

#### GLUCOSE - Read at exactly 30 seconds

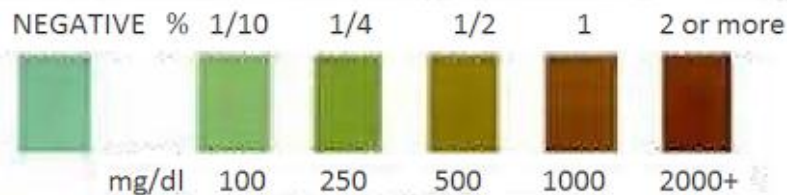

#### KETONE - Read at exactly 15 seconds



**2. Biosensor:** allows people with diabetes to check their blood to see how well they are controlling their glucose concentration



- **blood analysis:** quantitative data
- a pad **impregnated** with **glucose oxidase** catalyses reaction to form gluconolactone
- > generates tiny **electric current** that is detected by **electrode** and is read by a meter

**Exam question:** question 9, specimen paper 2016

- (b) Outline how a dip stick can measure the concentration of glucose **and** suggest advantages of using an electronic biosensor instead of a dip stick. [6]

*method*

1. stick dipped into urine ;
2. glucose oxidase (on stick) reacts with glucose (in urine) ;
3. forms gluconolactone ;
4. and hydrogen peroxide ;
5. (hydrogen peroxide) reacts with chromogen (on stick) ;
6. catalysed by peroxidase enzyme ;
7. colour produced matched against chart ; (*max 4*)

*advantages*

8. electronic biosensor does not involve colour matching ; ora  
A ref to subjectivity of results from dip sticks
9. gives a specific reading, not a range of values (if not an exact match to a colour) ; ora
10. biosensor gives a digital reading so no need to interpret a colour chart ;
11. biosensor can be re-used again ; ora (*max 3*)

[http://papers.gceguide.com/A%20Levels/Biology%20\(9700\)/9700\\_y16\\_sp\\_4.pdf](http://papers.gceguide.com/A%20Levels/Biology%20(9700)/9700_y16_sp_4.pdf)  
[http://papers.gceguide.com/A%20Levels/Biology%20\(9700\)/9700\\_y16\\_sm\\_4.pdf](http://papers.gceguide.com/A%20Levels/Biology%20(9700)/9700_y16_sm_4.pdf)

## #98 Homeostasis in plants

Stomata have daily rhythms of opening and closing and also respond to **changes** in **environmental conditions** to

- allow diffusion of **CO<sub>2</sub>**
- regulate **water loss** by transpiration



Stomata open due to:

- high light intensity
- low concentration of CO<sub>2</sub>

Stomata close due to:

- darkness
- high concentration of CO<sub>2</sub>
- low humidity
- high temperature
- water stress

### Opening and closing of stomata

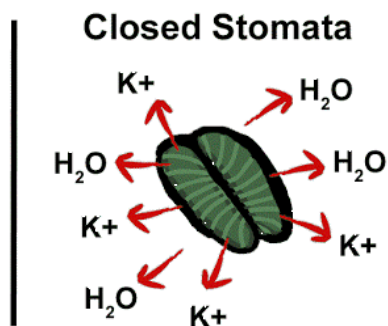
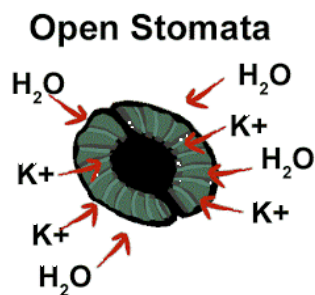

1. ATP powers proton pumps to **actively** transport **H<sup>+</sup> out** of cell
2. There is a low concentration of H<sup>+</sup> and negative charge inside the cell --> K<sup>+</sup> channels open --> **K<sup>+</sup> diffuse in**
3. High concentration of K<sup>+</sup> inside the cell **decreases water potential**
4. Water **moves in** via osmosis
5. Water entry increases the volume of the guard cell, causing it to **expand** --> open

## Structure of stomata

Each stomatal pore is surrounded by 2 guard cells. Guard cells:

- open when **turgid** (gain water)
- close when **flaccid** (lose water)

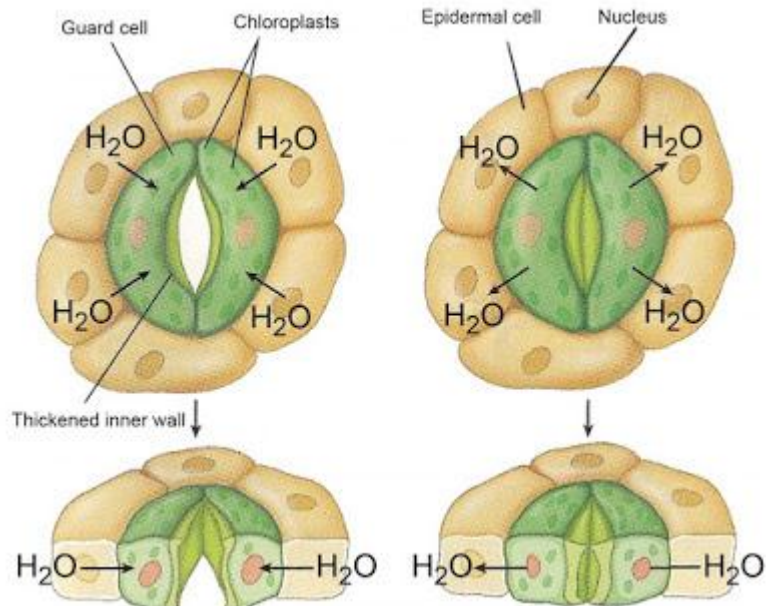

## Abscisic acid and stomatal closure

Abscisic acid (ABA) is a **stress hormone** that is secreted in response to difficult environmental conditions such as very high temperatures or much reduced water supplies. ABA triggers the **closure of stomata** to **reduce transpiration** and **prevent water loss**.

ABA binds to cell surface receptors

- **inhibits proton pumps**: stop  $H^+$  pumped out
- stimulates movement of  $Ca^{2+}$  through the cell surface membrane and tonoplast

$Ca^{2+}$  acts as a **2nd messenger** to activate channel proteins to open that allow negatively charged ions to leave the guard cell. This in turn

- opens channel proteins that allow  $K^+$  to leave the cell
- closes channel proteins that allow  $K^+$  to enter the cell
- --> net movement:  **$K^+$  leaves cell**

Loss of ions = higher water potential inside cell = water passes out by osmosis = guard cells become flaccid --> **stomata close**

## #99 Control and co-ordination in mammals, the nervous system

Humans, like all living organisms, can respond to changes in environment and so increase survival. Humans have 2 **control** systems to do this: the **nervous system** and the **endocrine (hormonal) system**. The human nervous system controls everything from breathing and standing upright, to memory and intelligence. It has 3 parts: detecting stimuli, coordinating and effecting a response.

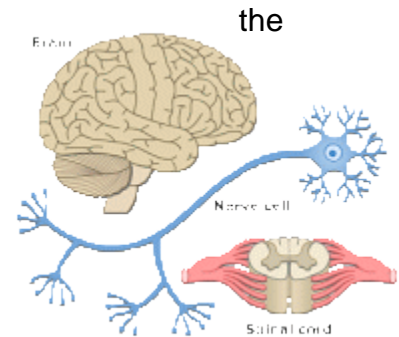

**Stimuli** are changes in the external or internal environment, such as light waves, pressure or blood sugar. Humans can detect at least nine external stimuli and dozens of internal stimuli, so the commonly-held believe that humans have just five senses is obviously very wide of the mark!

**Receptor cells** detect stimuli. Receptor cells are often part of sense organs, such as the ear, eye or skin. Receptor cells all have special receptor proteins on their cell membranes that actually do the sensing, so “receptor” can confusingly mean a protein, a cell or a group of cells.

**The coordinator** is the name given to the network of interneurons connecting the sensory and motor systems. It can be as simple as a single interneurone in a reflex arc, or as complicated as the human brain. Its job is to receive impulses from sensory neurones and transmit impulses to motor neurones.

**Effectors** are the cells that effect a response. In humans there are just two kinds: muscles and glands. Muscles include skeletal muscles, smooth muscles and cardiac muscle, and they cause all movements in humans, such as walking, talking, breathing, swallowing, peristalsis, vasodilation and giving birth. Glands can be exocrine – secreting liquids to the outside (such as tears, sweat, mucus, enzymes or milk); or endocrine – secreting hormones into the bloodstream.

**Responses** aid survival. They include movement of all kinds, secretions from glands and all behaviours such as stalking prey, communicating and reproducing.

### Coordination

In multicellular organisms, such as plants and animals, it is essential that cells can communicate with each other. This allows them to **coordinate** their activities appropriately. Organisms have specialised cells or molecules, called **receptors**, which are sensitive to changes in their internal or external environment. These trigger events in

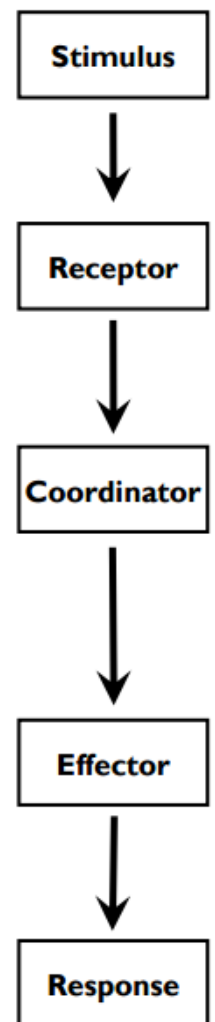

the organism that bring about coordinated responses to the environmental changes.

## 1) Nervous and endocrine systems as communication systems

a. The basic **similarities** of 2 systems:

- Provide the body with **methods to communicate** with its internal and external environments in order to coordinate responses.
- Employ **chemicals** to transmit messages and respond to **stimulus** caused by changes in their environments.

b. The **differences** in response times and how they work.

- The nervous system responds to stimuli by sending electrical action potentials along neurons, which in turn transmit these action potentials to their target cells using neurotransmitters, the chemical messenger of the nervous system. This response to stimuli is near **instantaneous**.
- Hormones are synthesized at a distance from their target cells, and travel through the bloodstream or intercellular fluid until they reach these cells. Upon reaching their target cell, the hormones act on the cell to increase or decrease the expression of specific genes. This process takes significantly longer, as hormones must first be synthesized, transported to their target cell, and enter or signal the cell. Then, the target cell must go through the process of transcription, translation, and protein synthesis before the intended action of the hormone is seen. Although hormones act more slowly than a nervous impulse, their effects are long lasting. Additionally, target cells can respond to minute quantities of hormones and are sensitive to subtle changes in hormone concentration.

c. The nervous and endocrine systems work together to maintain **homeostasis**.

The endocrine and nervous systems work independently to carry out unique functions by different methods with some similar elements. However, they do work together to control and co-ordinate the internal environment of the animal.

The nervous system responds rapidly to short-term changes by sending electrical impulses.

The endocrine system brings about longer-term adaptations by sending out chemical messengers (hormones) into the bloodstream.

## 2) Nerve cells/Neurones

The nervous system composed of nerve cells, or neurones. A neurone has a **cell body** with extensions leading off it. Several **dendrons** carry nerve impulses towards the cell body, while a single long **axon** carries the nerve impulse away from the cell body. Axons and dendrons are only 10µm in diameter but can be up to 4m in length in a large animal (a piece of spaghetti the same shape would be 400m long)! A **nerve** is a discrete



bundle of several thousand neurone axons.

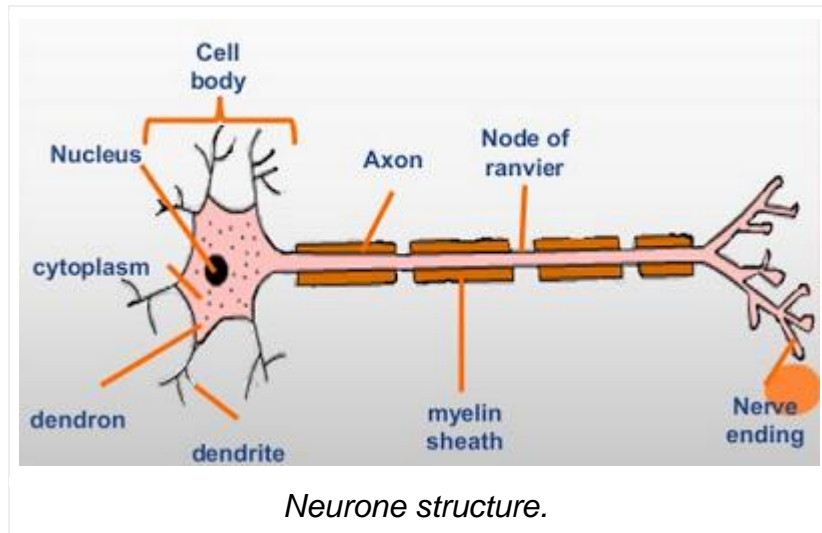

Nerve impulses are passed from the axon of one neurone to the dendron of another at a **synapse**. Numerous **dendrites** provide a large surface area for connecting with other neurones.

Most neurones also have many companion cells called **Schwann cells**, which are wrapped around the axon many times in a spiral to form a thick lipid layer called the **myelin sheath**. The myelin sheath provides physical protection and electrical insulation for the axon, which greatly speeds up the transmission of action potentials. There are gaps in the sheath, called **nodes of Ranvier**. Not all neurones are myelinated.

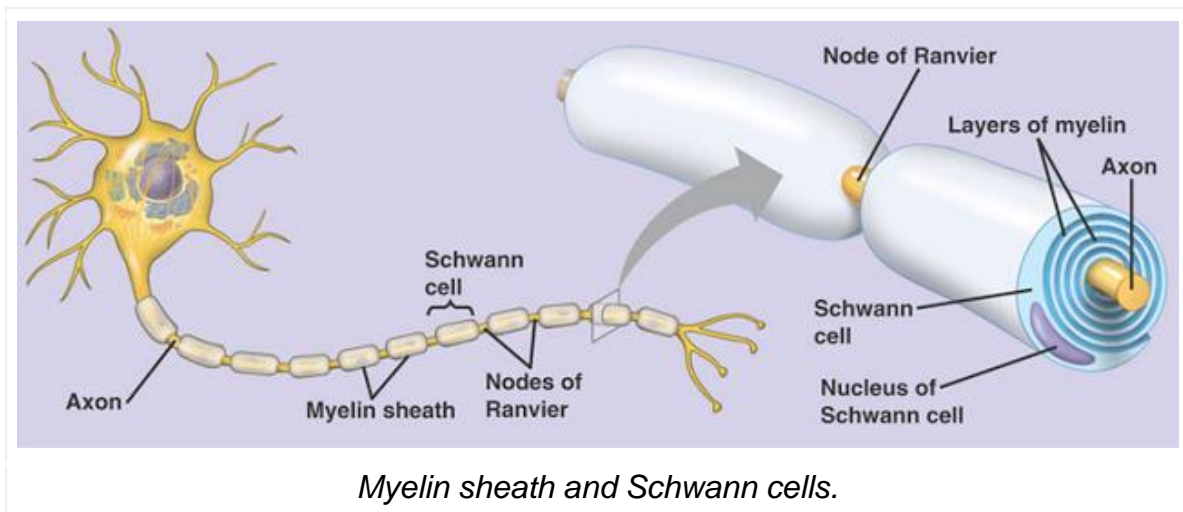

Humans have 3 types of neurone:

- **Sensory neurones** have long dendrons and transmit nerve impulses from sensory receptors all over the body to the central nervous system.

- **Motor neurones** have long axons and transmit nerve impulses from the central nervous system to effectors (muscles and glands) all over the body.
- **Interneurons** (also called connector neurones or **relay** neurones) are much smaller cells, with many interconnections. They comprise the central nervous system. 99.9% of all neurones are interneurons.

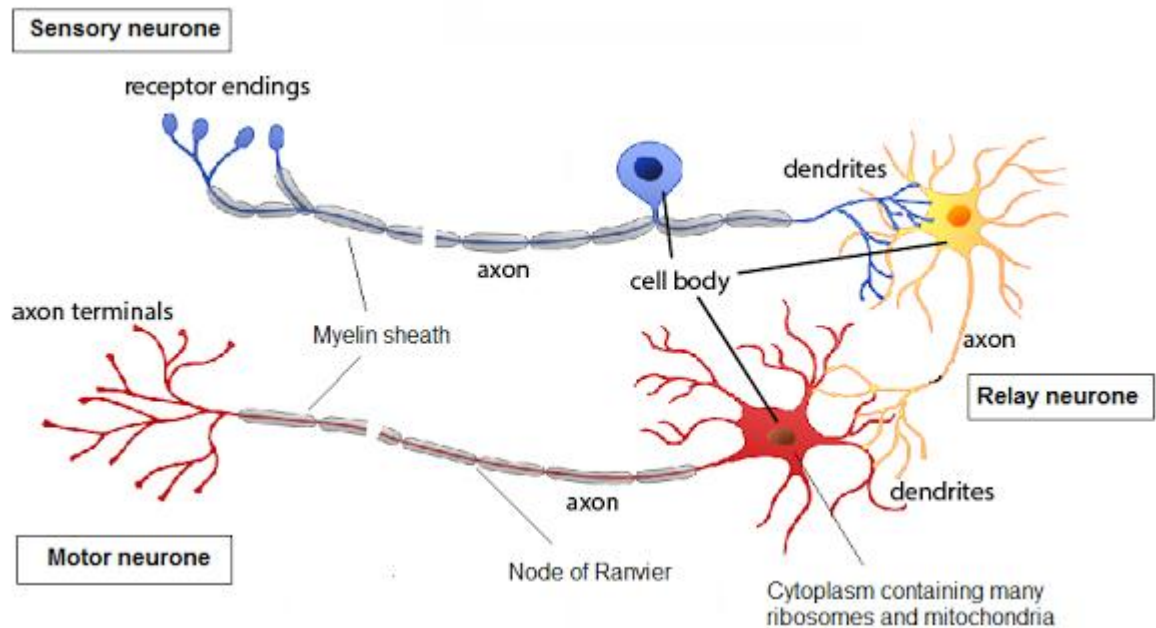

Neurons are highly specialised cells that are adapted for the rapid transmission of electrical impulses, called action potentials, from one part of the body to another.

Information picked up by a **receptor** is transmitted to the central nervous system (brain or spinal cord) as action potentials travelling along a **sensory neurone**. These neurons have their cell bodies in small swellings, called **ganglia**, just outside the spinal cord.

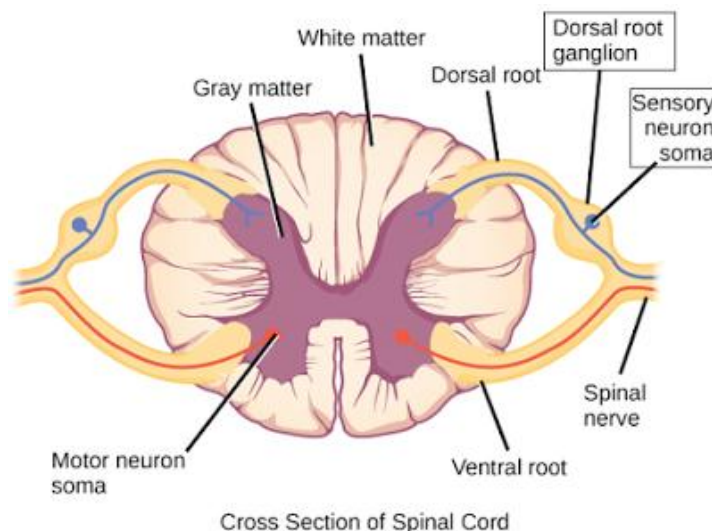

The impulse may then be transmitted to a **relay neurone**, which lies entirely within the brain or spinal cord.

The impulse is then transmitted to many other neurones, one of which may be a **motor neurone**. This has its cell body within the central nervous system, and a long **axon** which carries the impulse all the way to an **effector** (a muscle or gland).

### 3) Reflex arc

In some cases, the impulse is sent on to an effector before it reaches the 'conscious' areas of the brain. The response is therefore automatic, and does not involve any decision-making. This type of response is called a reflex, and the arrangement of neurones is called a **reflex arc**.

FLOW CHART OF A REFLEX ARC

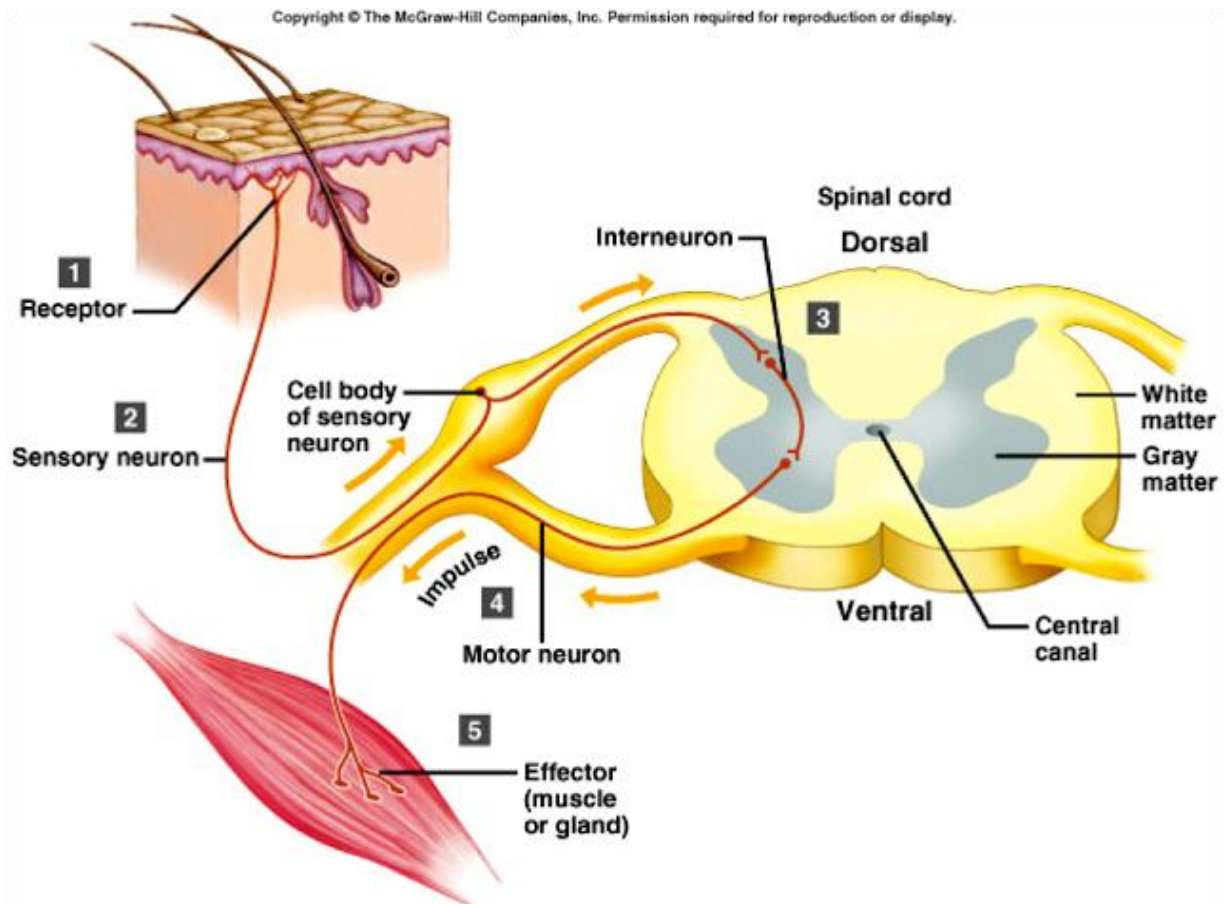
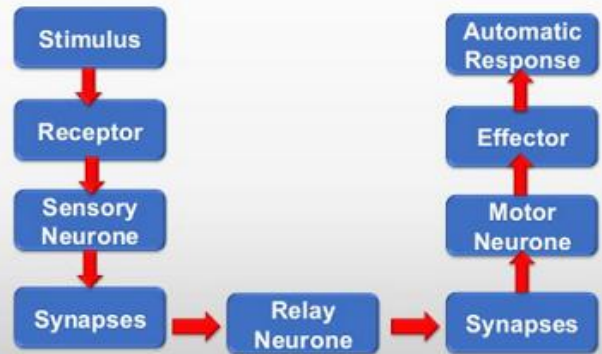

## #100 Action potentials

Action potentials are **rapid changes** in **potential difference** across the membrane.

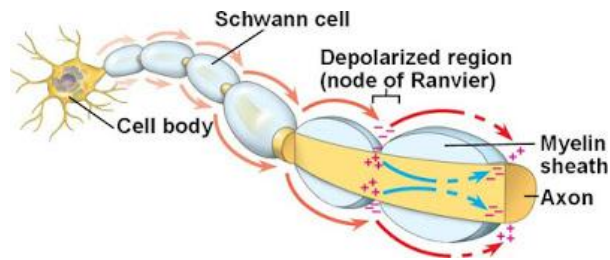

**Myelin:** specialized cells called **Schwann cells** wrapped along the axon.

- Schwann cells are made of lipids and proteins
- many Schwann cells form the **myelin sheath** → affects the **speed of conduction** of electrical impulses

Transmission of nerve impulses:

- impulse/signals are brief changes in the distribution of electrical charge across the cell surface membrane → results in action potentials
- caused by the rapid movement of **Na<sup>+</sup>** and **K<sup>+</sup>** ions **into** and **out** of the axon

### Resting potential

- inside the axon: slightly negative
- potential difference: -60mV to -70mV (potential inside the axon is less than that outside the axon)

Neurons, like all cells, have **sodium-potassium pumps** in their cell surface membranes. However, in neurons these are especially active. By **active transport**, they pump out 3 Na<sup>+</sup> ions for every 2 K<sup>+</sup> ions brought in.

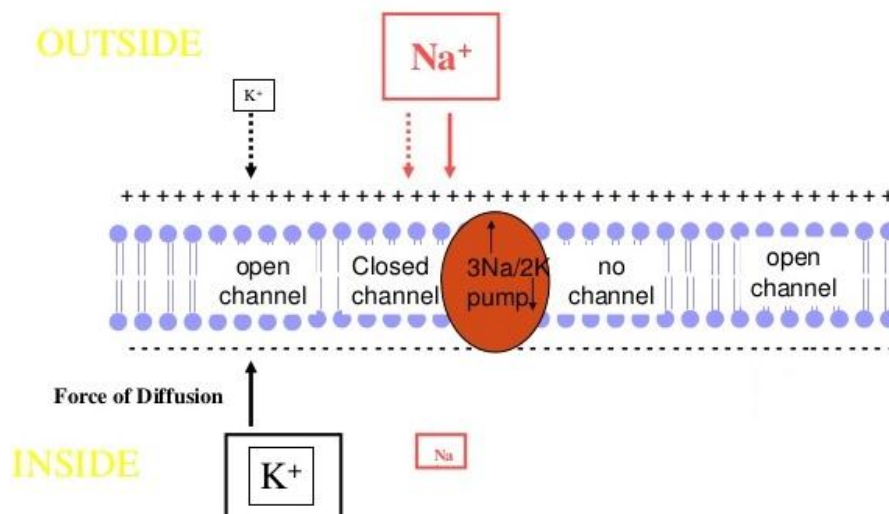

- the resting potential is produced and maintained by  $\text{Na}^+$  and  $\text{K}^+$  ion pumps:
  - membrane proteins
  - uses energy from the hydrolysis of ATP for active transport of ions
- there are more channels for  $\text{K}^+$  ions; large, negative molecules inside cell attracts  $\text{K}^+$  ions  $\rightarrow$  less  $\text{K}^+$  ions diffuse out  $\rightarrow$  there is an overall excess of negative ions inside the membrane

**Action potentials** - the rapid change in potential difference across the membrane

- caused by the change in permeability of the membrane to  $\text{Na}^+$  and  $\text{K}^+$  ions
- voltage gated channels for  $\text{Na}^+$  and  $\text{K}^+$  ions : opens or closes depending on the potential difference across the membrane

When a receptor **receives a stimulus**, this can reduce the potential difference across the membrane, which causes sodium ion channels to open. This allows sodium ions to flood into the cell, down an **electrochemical gradient**. (The 'electro' gradient refers to the difference in charge across the membrane. The 'chemical' gradient is the difference in concentration of sodium ions.)

- **depolarization**:  $\text{Na}^+$  channels open  $\rightarrow$   $\text{Na}^+$  enter  $\rightarrow$  potential difference is less negative on the inside (now at approx. +30mV)
- potential difference reaches the threshold potential  $\rightarrow$  generates an action potential
- **repolarization**:  $\text{Na}^+$  channels close,  $\text{K}^+$  channels open  $\rightarrow$  outward movement of  $\text{K}^+$  down their electrochemical gradient removes the positive charge inside the axon

This sequence of events is called an action potential.

- **refractory period**: period of time where the axon is unresponsive, recovering from an action potential (restoring its resting potential); another action potential cannot be generated until this period is over

### Transmission of action potentials

An action potential generated in one part of a travels rapidly along its axon or dendron. happens because the temporary depolarisation of one part of the membrane **sets up local circuits** with the either side of it. These cause depolarisation regions as well. The nerve impulse therefore sweeps along the axon.

\*Action potentials only take place at the **nodes of Ranvier**, where there is no myelin present.

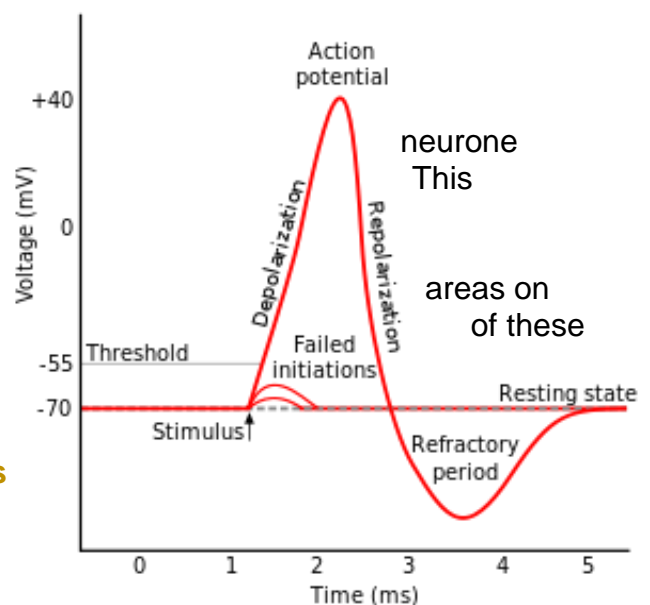

### How an action potential carries information

- action potentials have same:
  - size (same amplitude)
  - speed at which the action potential travels by
- action potentials have different:
  - frequency
  - number of neurones carrying an action potential

---> acts as a representation of the strength of the stimulus

- nature of the stimulus: deduced from the position of the sensory neurone

### Initiation of an action potential

Receptors are cells or tissues that sense changes in the internal or external environment. Many types of **receptor** transform energy (**transducers**) from a stimulus into the energy of an action potential in a sensory neurone.

- Receptors are stimulated: receptor potential rises **above threshold potential** → action potential initiated → stimulates sensory neurones to send impulses to CNS
- **all-or-nothing law**: neurones either do or do not transmit electrical impulses
- threshold levels rarely stay constant

### Speed of conduction

- Myelin insulates the membrane of the axon → speeds up rate by which the action potential travels
- “local circuits” exist from one node to the next, thus creating “**saltatory conduction**” where an action potential jumps from one node to the next
- with myelin: speed of conduction is 50 times faster
- diameter of axon increase = less resistance = faster transmission

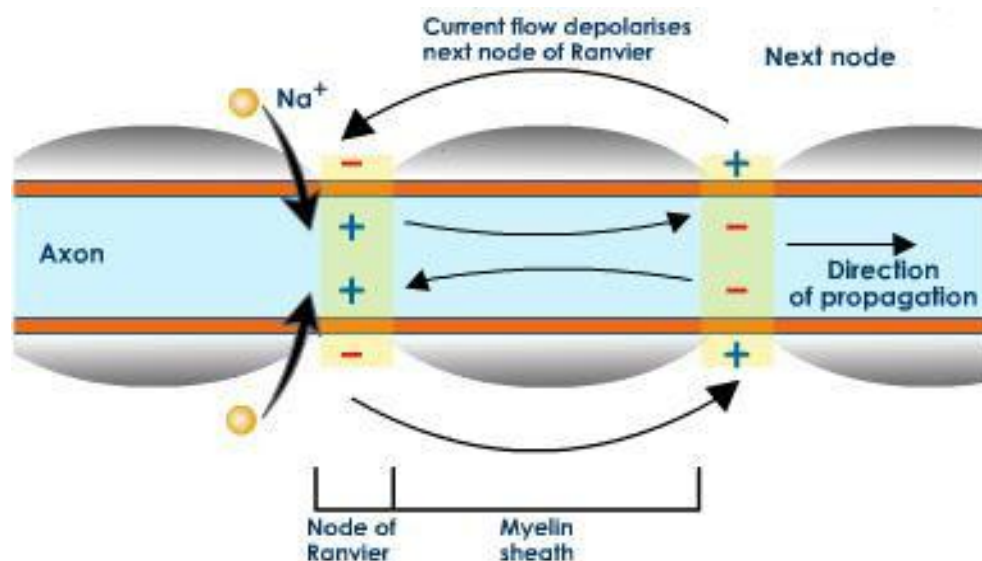

## #101 Synapses

### Synapse

- point where 2 neurones **meet** but do not touch
- contains the end of **presynaptic** neurone + synaptic **cleft** + end of **postsynaptic** neurone

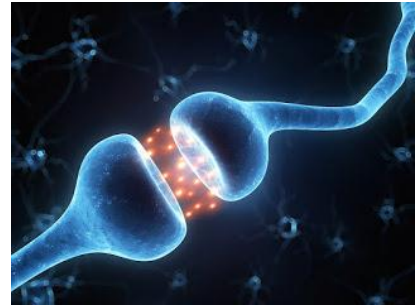

### Mechanism of synaptic transmission

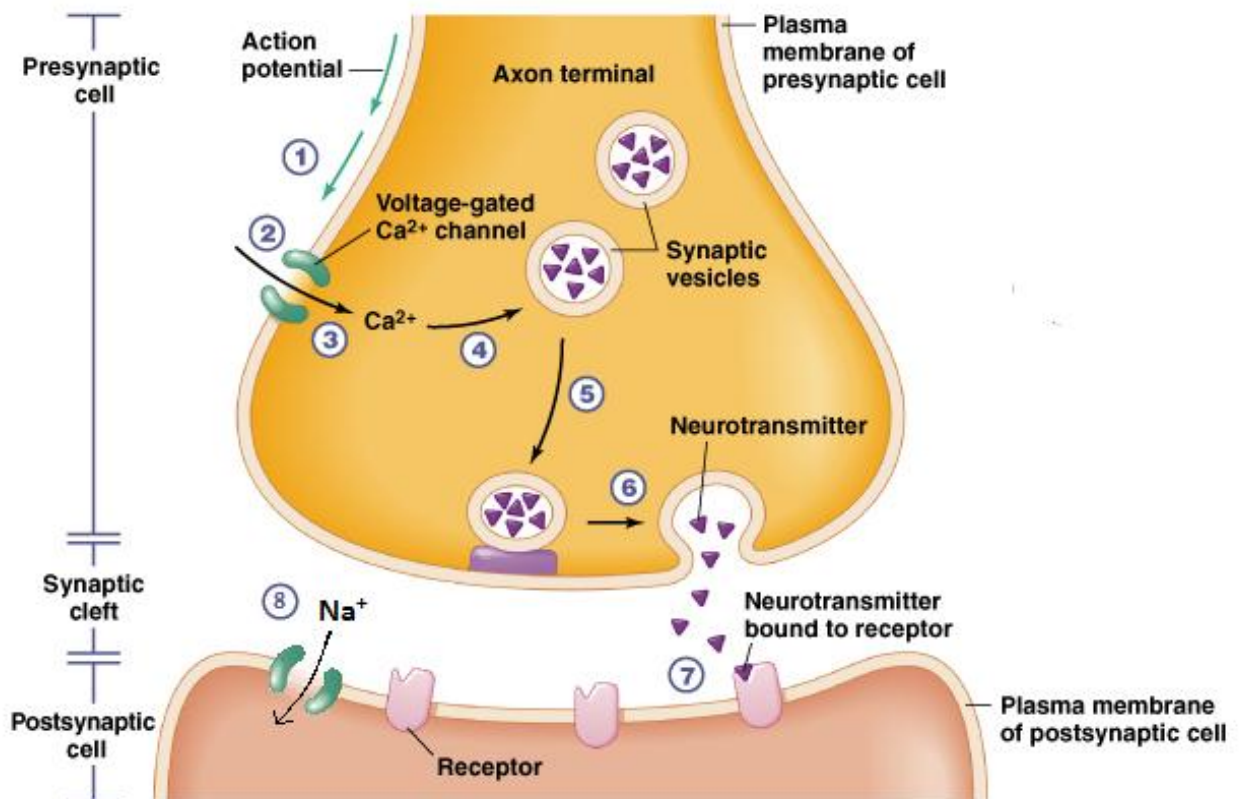

1. action potential arrives at presynaptic neurone
2. stimulates opening of **voltage-gated channels** for **Ca<sup>2+</sup>**
3. Ca<sup>2+</sup> **diffuse** into cytoplasm of presynaptic membrane
- 4+5. Ca<sup>2+</sup> cause vesicles containing acetylcholine (ACh – a type of neurotransmitter) move towards the presynaptic membrane

6. Vesicle **fuses** with the membrane, Ach is released and **diffuses across** the synaptic cleft
7. Ach **temporarily binds** to receptor proteins on the postsynaptic membrane; causes chemically-gated ion channels for  $\text{Na}^+$  to open
8.  $\text{Na}^+$  diffuse through postsynaptic membrane → **depolarizes membrane** → generates action potential
9. **Recycling of Ach**, catalysed by acetylcholinesterase (stops continuous production of action potentials)



10. choline moves back into the presynaptic neurone



ACh transported back to presynaptic vesicles

### **Functions of synapses**

1. ensures **one-way transmission**: neurotransmitters are only released on one side of synapse; receptors on the other side of synapse

2. **integration of impulses**: the body of motor neurones are covered with terminations of multiple relay neurones. The motor neurone only transmits impulses and initiate action potentials **if the threshold potential is reached**. This ensures that the brain is not overloaded with sensory information.

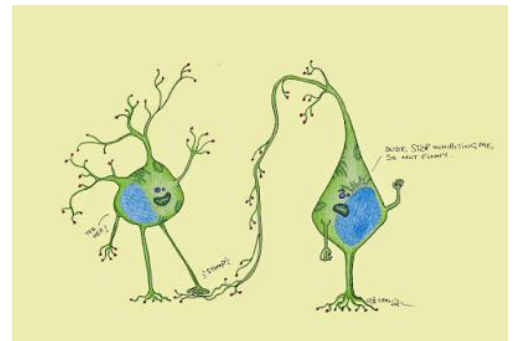

3. allow **connection of nerve pathways**: axons branch out to form more synapses with multiple neurones → humans have a wider range of behaviours

- **in dangerous situations**: information from 1 neurone spreads throughout the body to reach many relay neurones and effectors
- **decision-making in brain**: motor neurones have many dendrites → larger surface area for a lot of synapses → neurone can integrate information from many parts of the body

4. involved in **memory making and learning**: e.g.: brain receives information about 2 things at the same time → new synapses form



## #102 Striated muscles

**Striated muscles** are muscles attached to the **skeleton**. They are **neurogenic** - they contract when stimulated to do so by impulses that arrive via motor neurones.

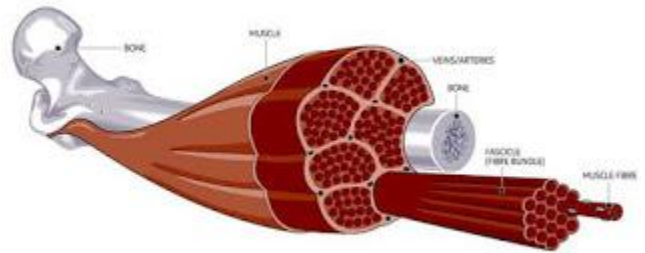

### Structure of a striated muscle

- a muscle contains many **muscle fibres**
- muscle fibres are made up of specialized cells called **syncytium**

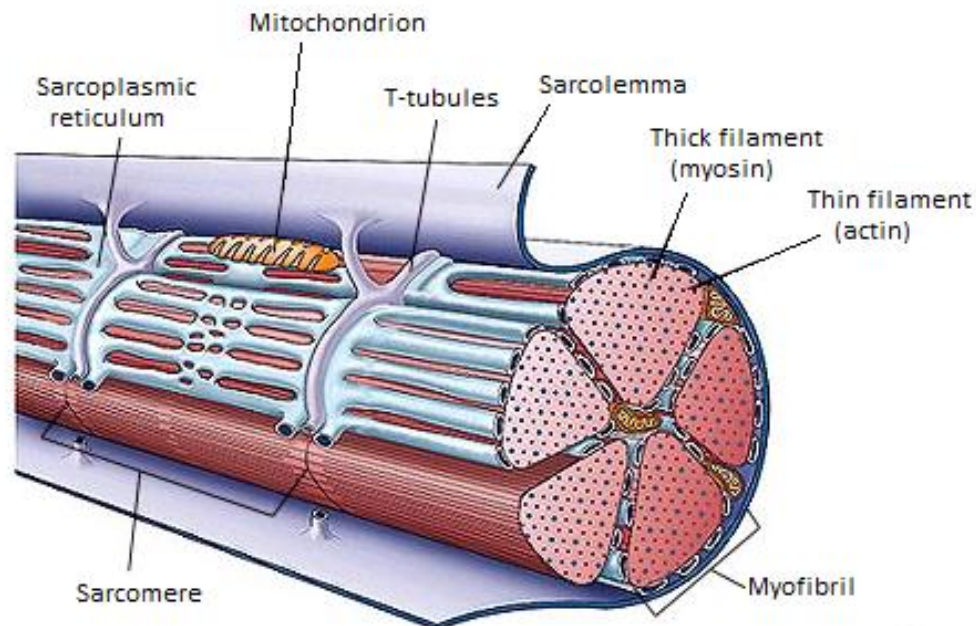

- **Sarcolemma**: cell surface membrane
- **Sarcoplasm**: cytoplasm // large numbers of **mitochondria** packed between myofibrils to perform aerobic respiration and produce ATP required for muscle contraction
- **Sarcoplasmic reticulum (SR)**: cell surface has large numbers of **protein pumps** to transport  $\text{Ca}^{2+}$  into cisternae of SR
- **T-tubules**: deep infoldings into the interior of the muscle fibre

### **Myofibril**

- **Striations**: stripes on a muscle fibre, produced by the **regular arrangement** of many **myofibrils**. Each myofibril is made up of **parallel groups** of thick filaments that lie between groups of thin filaments.

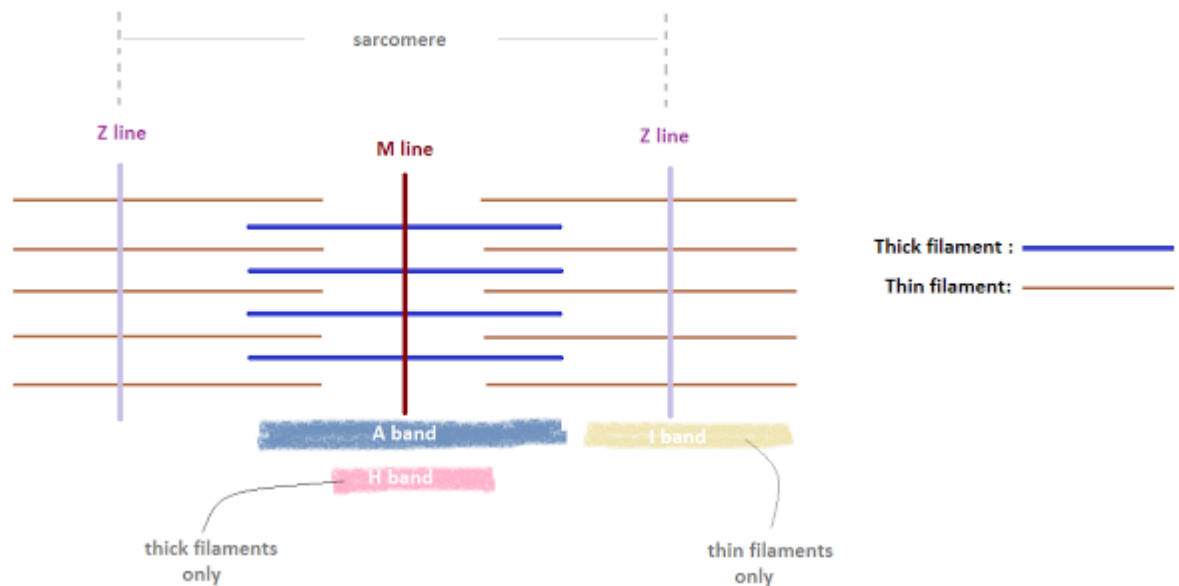

### Structure of thick and thin filaments

**Thick filaments:** made of **myosin** – a **fibrous protein** with a **globular head** that **points away** from the M-line

### Thin filaments:

- **actin:** **globular protein**. Many actin molecules link together to form a chain. **2 chains** twisted together form the thin filament
- **tropomyosin** (**fibrous protein**) twisted around the 2 chains
- **troponin:** attached to actin chain at regular intervals

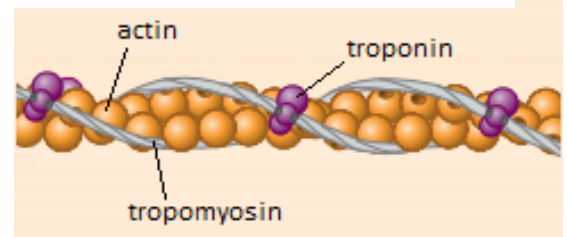

### How muscles contract

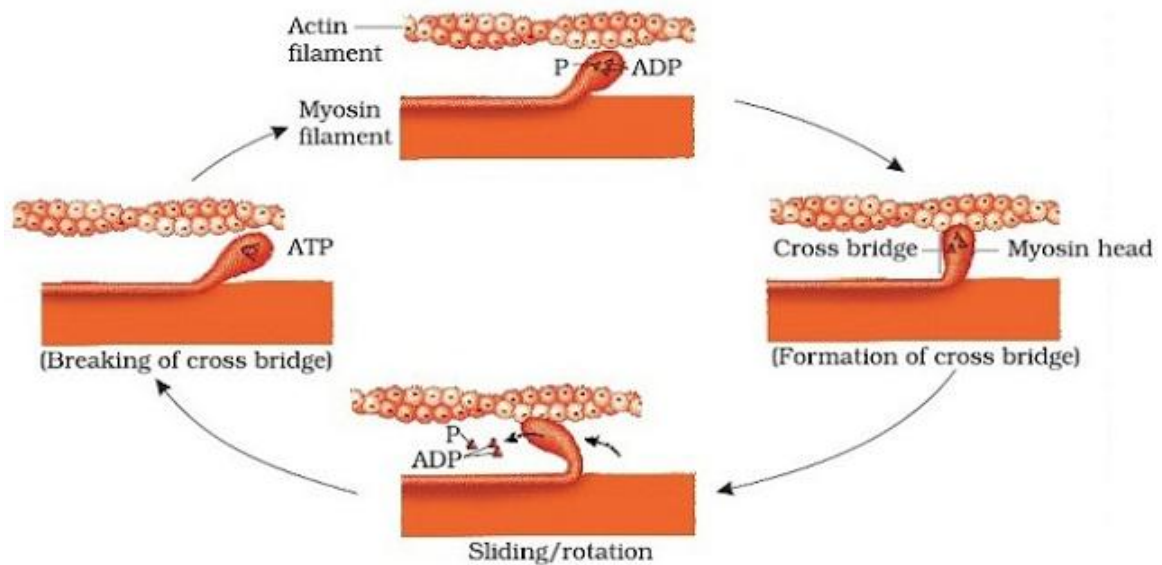

1. Muscle contracts; **Ca<sup>2+</sup> released** from stores in SR and binds to troponin
2. Troponin molecules **change shape**
3. Troponin and tropomyosin move to **different positions** on the thin filament to expose myosin-binding sites on the actin chain; **Cross-links** form between the thick and thin filaments
4. Myosin heads **tilt** and pull actin filaments **towards** the sarcomere centre
5. **ATP hydrolysis** forces heads to **let go** of actin
6. Heads spring back and the process repeats so long as:
  - troponin and tropomyosin molecules don't block the binding site
  - muscles have a supply of ATP

**Stimulating muscles to contract:**

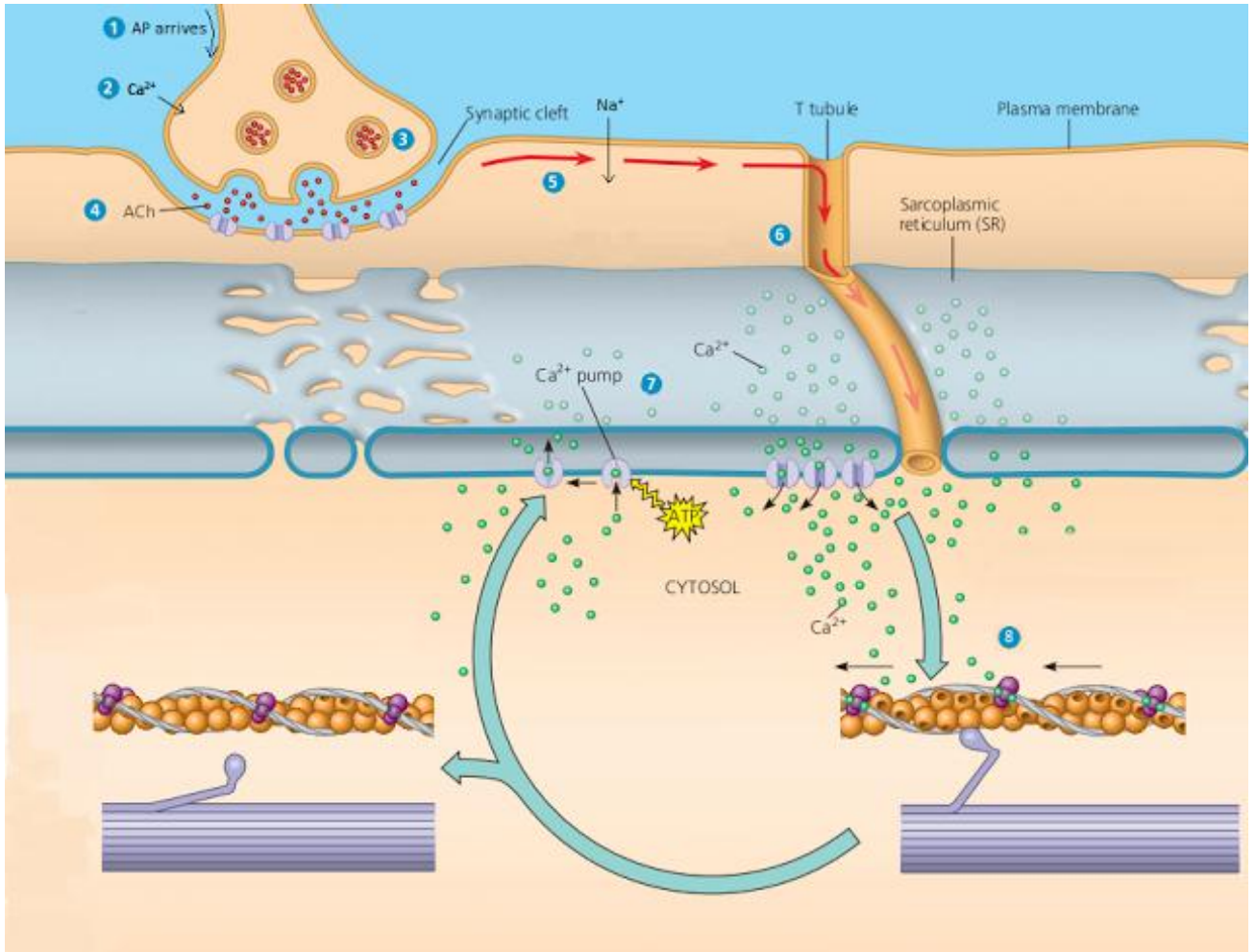

1. action potential arrives at presynaptic neurone
2. stimulates opening of **voltage-gated channels** for **Ca<sup>2+</sup>** to **diffuse** into cytoplasm
3. Ca<sup>2+</sup> cause vesicles containing acetylcholine (ACh) to move towards the presynaptic membrane
4. Vesicle **fuses** with the membrane, Ach is released and **diffuses across** the neuromuscular junction; Ach **temporarily binds** to receptor proteins on the sarcolemma; causes chemically-gated ion channels for Na<sup>+</sup> to open
5. Na<sup>+</sup> diffuse into the sarcolemma → **depolarizes membrane** → generates action potential that spreads along the membrane
6. Depolarization of sarcolemma **spreads down** to **T-tubules**
7. Channel proteins open: **Ca<sup>2+</sup>** **diffuses out** of **SR**
8. Ca<sup>2+</sup> binds to **troponin**. **Tropomyosin** moves to **expose myosin-binding sites** on actin filament; Myosin heads form cross-bridges with thin filaments → **sarcomere shortens**.

**Providing ATP for muscle contraction**

1. aerobic respiration in mitochondria
2. lactic fermentation in sarcoplasm
3. **creatine phosphate**: is stored in the sarcoplasm and acts as an immediate source of energy when ATP in the sarcoplasm runs out



- when the demand for energy is slowed down or stopped, ATP molecules **recharge** creatine



- when the demand for energy is high, but no ATP is spare to recycle creatine

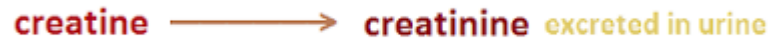

## #103 Hormonal communication

Hormones like adrenaline, insulin, glucagon and ADH

- **cell-signalling** molecules
- made in **endocrine glands**; glands are groups of cells that **secrete** (produce and release) one or more substances
- passed directly into the blood



**Steroid hormones** are lipid soluble → pass through phospholipid bilayer and binds to **receptor molecules** inside the cytoplasm/nucleus and activate processes

**Menstrual cycle:** changes that reoccur in the ovary and uterus every 28 days involving:

- **ovulation**
- **menstruation:** the breakdown and loss of the uterus lining

\* uterine cycle and ovarian cycle are **synchronized**

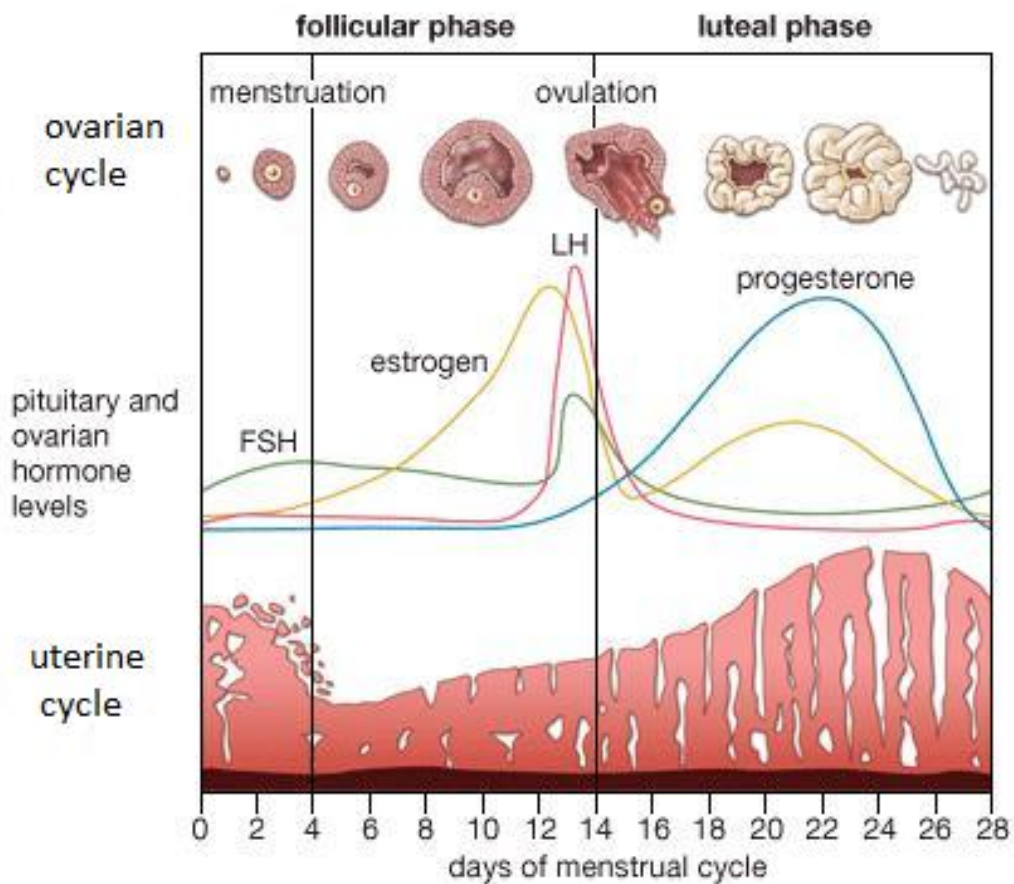

The menstrual cycle is coordinated by glycoprotein hormones secreted by the **anterior pituitary gland** and **ovaries**

1. During menstruation, the **anterior pituitary gland** secretes

- **follicle stimulating hormone (FSH)**
- **luteinising hormone (LH)**

Concentrations of FSH and LH increase over the next few days → **control activity of ovaries** – responsible for ovulation

2. In the ovary, one follicle becomes the '**dominant**' one

- the presence of FSH and LH stimulates cells surrounding the follicle to secrete **oestrogen**
- the production of oestrogen induces a **negative feedback** and decreases the production and concentration of FSH and LH

Oestrogen stimulates the endometrium to:

- grow, thicken
- develop numerous blood capillaries

3. There is a **surge of LH** secretion and a **slight increase in FSH** secretion. The high concentration of LH causes the follicle to burst and **shed the gamete** into the oviduct. The remnants of the follicle collapse and forms the **corpus luteum** (yellow body)  
Corpus luteum secretes:

- **progesterone**: inhibits the anterior pituitary gland from secreting FSH and LH → no more follicles develop
- some oestrogen

→ **maintains** the **uterus lining** so that it's ready to receive an embryo if fertilisation occurs

4. Low stimulation of the corpus luteum causes it to **degenerate**. As a result, less oestrogen and progesterone is secreted and their concentrations decrease →

- endometrium is not maintained → menstruation begins
- releases inhibition of anterior pituitary gland → FSH gets secreted → another cycle begins!

## #104 Birth control

'Birth control' means taking control over if and when a couple have a child. It may involve:

- **contraception** to prevent fertilisation
- use of **hormones** to prevent pregnancies

### 1. The birth control pill

The pill contains **steroid hormones** that **suppress ovulation**.

These **synthetic hormones** break down more slowly in the body so they act for longer; they are taken as **oral contraceptives**

- type 1: progesterone only
- type 2: progesterone and oestrogen combined

The woman takes one pill daily for 21 days and then stops for 7 days during which time menstruation occurs.

- oestrogen and progesterone **suppress** the secretion of **FSH and LH** from the **anterior pituitary gland** (negative feedback effect). This prevents the concentrations of FSH and LH from reaching levels that would stimulate ovulation.
- after 21 days, concentration of oestrogen and progesterone **fall** (inactive pills taken). The uterine lining is no longer maintained and **menstruation occurs**

Progesterone may allow ovulation to occur BUT is still a contraceptive because:

- it **decreases** the ability of sperm to fertilise egg
- it makes the **mucus** in the **cervix** **more viscous** → mucus is less easily penetrated by sperm

### 2. The morning after pill

The pill is taken up to 72 hours after a woman has had unprotected sex.

It contains a **synthetic progesterone-like hormone**:

- **decreases chances** of sperm reaching and fertilising the egg
- prevents pregnancy by **stopping** the **embryo** from **implanting** itself into the uterus lining





## #105 Venus fly trap

The Venus fly trap is a **carnivorous plant** that obtains a supply of nitrogen compounds by **trapping** and **digesting** small animals, mostly insects.

Anatomy of the Venus fly trap

- Midrib = hinge
- 2 lobes
- **glands** that secrete **digestive enzymes**
- 3 **sensory hairs** on each lobe that **respond** when they are **deflected**
- **nectar-secreting glands** to attract insects
- stiff **outer-edges** that interlock to trap insects

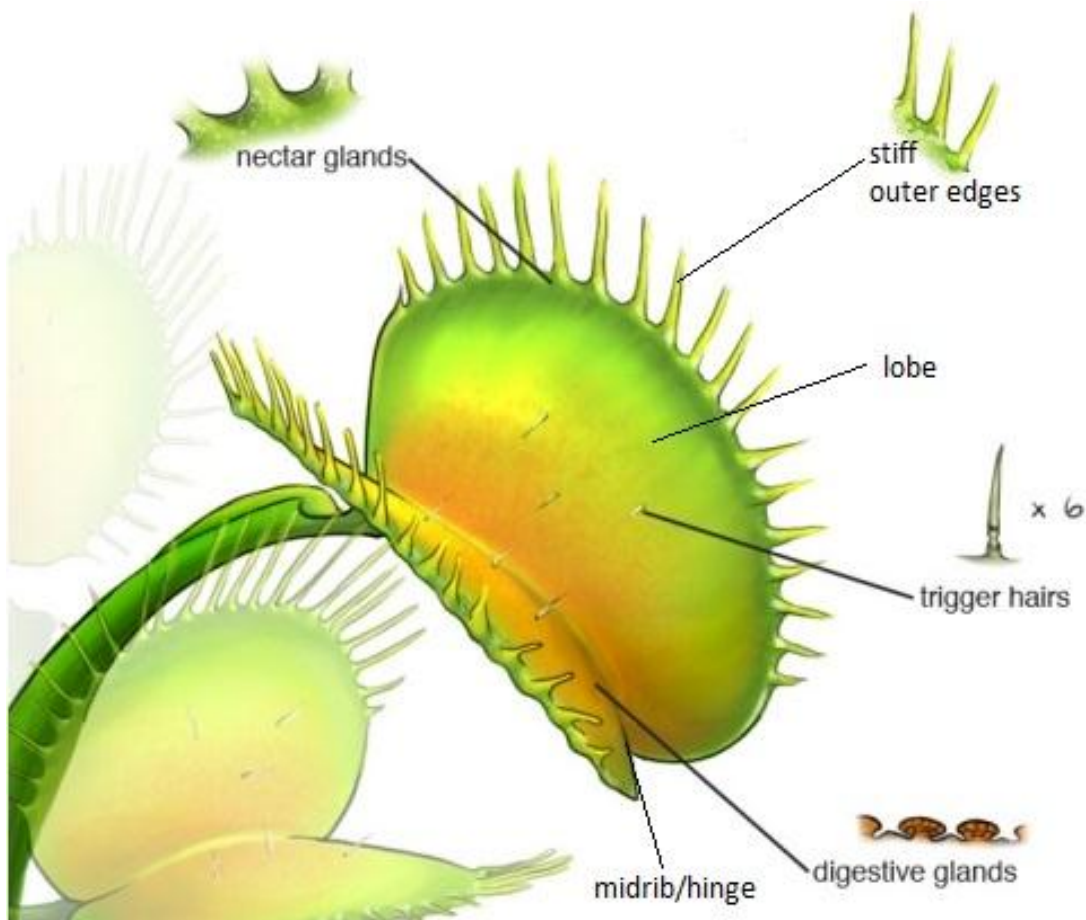
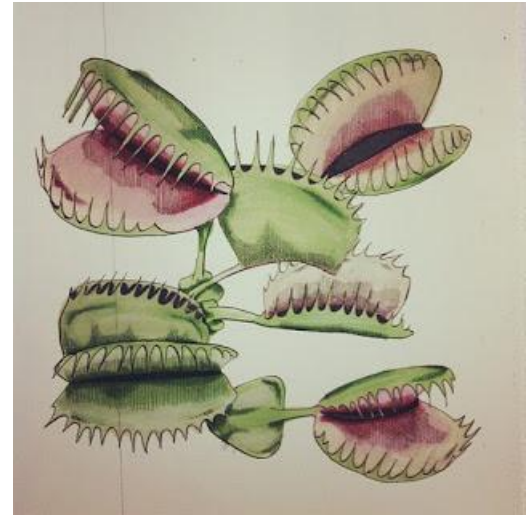

### **Electrical communication in plants**

- microelectrodes in leaf cells detect changes in potential difference.
- **depolarisation** results from the **outflow of  $\text{Cl}^-$**
- **repolarisation** is achieved by the **outflow of  $\text{K}^+$**
- action potentials travel along cell membranes, from cell to cell through **plasmodesmata**
- these action potentials last longer and travel more slowly than in animal neurones

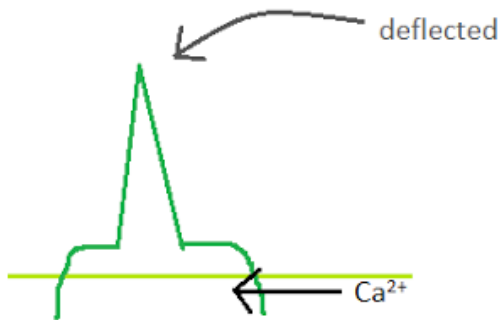

1. Sensory hair is deflected

2.  **$\text{Ca}^{2+}$  channels** at the base of the hair **opens**.  $\text{Ca}^{2+}$  flows in and generates a **receptor potential**.

3. Within 20 - 35 seconds, if **2 hairs** get stimulated or **1 hair is stimulated twice**, an action potential will spread across the lobe --> **trap closes**

Further stimulation (deflection of hairs) will force the **edges of lobes** to **seal** --> more  $\text{Ca}^{2+}$  enter cells --> stimulates the **exocytosis** of vesicles containing digestive enzymes.

Once the insect is digested, the cells on the upper surface of the midrib grow slowly so the leaf reopens and tension builds in the cell walls of the midrib so the trap is set again.

### **Adaptations to reduce waste of energy**

- **one hair stimulated** will not close the trap e.g.: wind, raindrop
- **gap** between stiff outer edges allow small insects to escape because they are not worth it

## #106 Plant hormones - Auxin

Chemical communication in plants

Plant hormones or plant growth regulators are:

- produced in a variety of tissues
- move from cell to cell (by diffusion or active transport) or carried in xylem sap and phloem sap

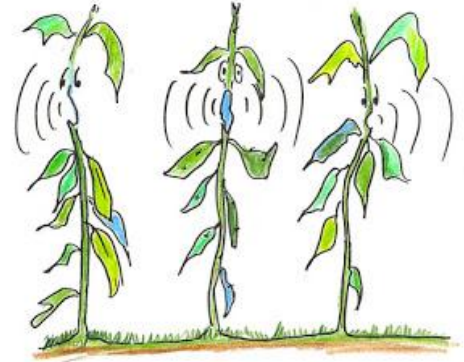

The two types we're going to look at **auxin** and **gibberellin**.

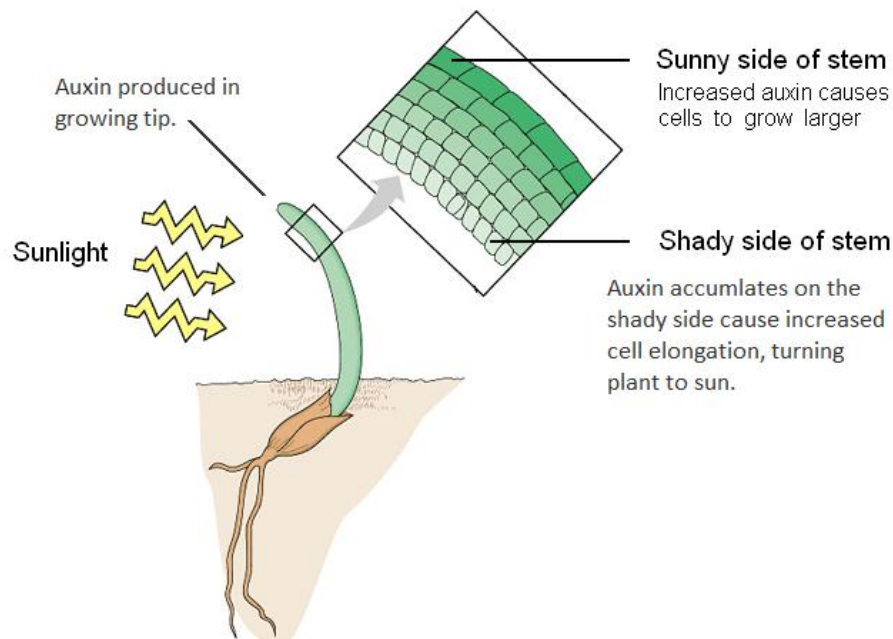

### **Auxin**

**Synthesized in meristems** (the growing tips of shoots and tips of roots, where cell division occurs). It gets actively transported away from the meristems, from cell to cell and via phloem sap.

#### **Function: controlling growth**

1. cell division: mitosis
2. **cell elongation** (by absorption of water; auxin is involved)
3. cell differentiation

### Mechanism of auxin

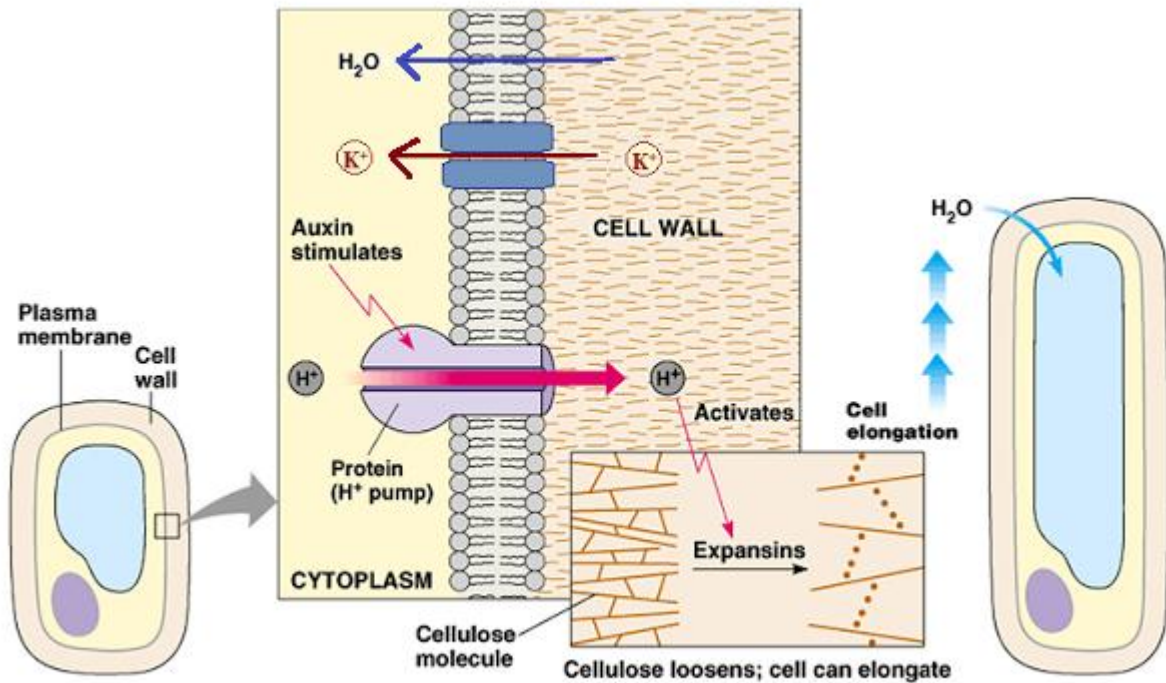

1. Auxin binds to receptor
2. Stimulates **ATPase** to pump **H<sup>+</sup>** across the cell surface membrane (from cytoplasm to cell wall, therefore lowering the pH of the cell wall)
3. Potassium ion channels stimulated to open; **K<sup>+</sup> move into** the cytoplasm, therefore **lowering the water potential inside** the cytoplasm --> **water moves into** the cytoplasm via osmosis
4. **Expansins** (proteins) are activated by the decrease in pH. Expansins **loosen linkages** between cellulose microfibrils.
5. Disruption occurs briefly --> **cells expands** without losing overall wall strength

## #107 Plant hormones - Gibberellin

Gibberellins are **plant growth regulators** that are synthesized in **most parts of plants** (mainly in young leaves and seeds and in stems). They have a role in **seed germination** and controlling **stem elongation**.



Stem elongation

The height for some plants is partly controlled by their genes. Tallness in pea plants is affected by a gene with two alleles Le/le

1. dominant allele **Le**:

- codes for the **functional enzyme** of the **active form** of gibberellin GA1 --> stimulates cell division and cell elongation
- plant grows **tall**

2. recessive allele **le**:

- caused by a substitution mutation (alanine to threonine amino acid)
- homozygous recessive **lele**: **no active form** of gibberellin
- plant remains **short**

**Seed germination:** of wheat and barley

Seeds are **dormant** (waiting for the optimum condition) when first shed from parent plant. It contains very little water and is metabolically inactive.

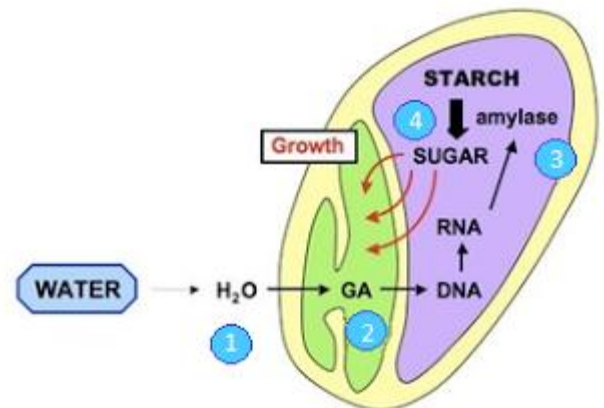

1. Absorption of **water** stimulates germination
2. Embryo **synthesizes gibberellin** in response to water uptake
3. Aleurone layer **synthesizes amylase** in response to gibberellin
4. Amylase **mobilizes energy reserves**: hydrolyses starch to maltose. Maltose is converted to glucose and respired to release ATP

## #108 Summary of Homeostasis and Co-ordination

1 Animals and plants have internal communication systems that allow information to pass between different parts of their bodies, and so help them to respond to changes in their external and internal environments.

2 Mammals keep their internal environment relatively constant, so providing steady and appropriate conditions within which cells can carry out their activities. This is known as homeostasis.

3 Homeostatic equilibrium requires receptors that detect changes in physiological parameters such as the temperature, water potential and pH of the blood. Effectors are the cells, tissues and organs that carry out the functions necessary to restore those parameters to their set points. Homeostatic control systems use negative feedback in which any change in a parameter stimulates actions by effectors to restore the parameter to its set point.

4 Excretion is the removal of toxic waste products of metabolism, especially carbon dioxide and urea. The deamination of excess amino acids in the liver produces ammonia, which is converted into urea, the main nitrogenous waste product. Urea is excreted in solution in water, as urine.

5 The kidneys regulate the concentration of various substances in the body fluids, by excreting appropriate amounts of them. Each kidney is made up of thousands of nephrons and their associated blood vessels. The kidneys produce urine by ultrafiltration and reabsorption, plus some secretion of unwanted substances. Different regions of a nephron have different functions, and this is reflected in the structure of the cells that make up their walls.

6 Blood is brought to the glomerulus in an afferent arteriole. High hydrostatic pressure in the glomerulus forces substances through the capillary walls, the basement membrane and inner lining of Bowman's capsule. The basement membrane acts as a filter, allowing only small molecules through. This filtrate collects in Bowman's capsule and then enters the proximal convoluted tubule, where most reabsorption occurs by diffusion and active transport; substances are also reabsorbed in the distal convoluted tubule and collecting duct. The loop of Henle acts as a counter-current multiplier, producing high concentrations of sodium and chloride ions in the tissue fluid in the medulla. This tissue has a very low water potential. Water is reabsorbed from fluid in the collecting duct by osmosis if the body is dehydrated.

7 The water content of the blood is controlled by changing the amount of water excreted in the urine by the kidneys. This is done by regulating the permeability of the walls of the collecting ducts to water, and hence the volume of water reabsorbed from the collecting ducts into the blood. The permeability is increased by the hormone ADH, which is secreted by the posterior pituitary gland in response to stimulation of osmoreceptors in the hypothalamus.



8 Neurones are cells adapted for the rapid transmission of electrical impulses. Sensory neurones transmit impulses from receptors to the central nervous system (brain and spinal cord); motor neurones transmit impulses from the central nervous system to effectors; intermediate neurones transmit impulses within the central nervous system. The three neurones are found in series in reflex arcs that control fast, automatic responses to stimuli. In vertebrates, the axons of many neurones are insulated by a myelin sheath, which speeds up transmission.

9 Neurones have a resting potential, which is a potential difference across their membranes, with the inside having a negative potential compared with the outside; this potential difference is about  $-65$  mV. An action potential is a rapid reversal of this potential, caused by changes in permeability of the cell surface membrane to potassium and sodium ions. Action potentials are always the same size. Information about the strength of a stimulus is given by the frequency of action potentials produced.

10 Action potentials are propagated along axons by local circuits that depolarise regions of membrane ahead of the action potential. This depolarisation stimulates sodium ion voltage-gated channels to open, so that the permeability to sodium increases and the action potential occurs further down the axon. Axons are repolarised by the opening of potassium ion voltage-gated channels that allow potassium ions to diffuse out of the axon. After a short refractory period when the sodium channels cannot open, the membrane is able to respond again. Refractory periods determine the maximum speed of impulses.

11 Action potentials may be initiated within the brain or at a receptor. Receptors respond to information from the environment. Environmental changes result in permeability changes in the membranes of receptor cells, which in turn produce changes in potential difference across the membrane. If the potential difference is sufficiently great and above the threshold for the receptor cell, this will trigger an action potential in a sensory neurone. Receptors are transducers converting the energy of stimuli into electrical impulses.

12 A synapse is a junction between two neurones or between a motor neurone and a muscle cell. At cholinergic synapses, a transmitter substance, acetylcholine, is released when action potentials arrive. Impulses pass in one direction only, because transmitter substances are released by exocytosis by the presynaptic neurone to bind to receptor proteins that are only found on the postsynaptic neurone.

13 Any one neurone within the central nervous system is likely to have at least several hundred synapses with other neurones, some of which will be stimulatory and some inhibitory. This allows integration within the nervous system, resulting in complex and variable patterns of behaviour, and in learning and memory.

14 Hormones are chemicals that are made in endocrine glands and transported in blood plasma to their target cells, where they bind to specific receptors and so affect the behaviour of the cells.

15 The concentration of glucose in the blood is controlled by the action of insulin and glucagon, which are secreted by the islets of Langerhans in the pancreas and affect

liver and muscle cells. The use of negative feedback keeps the blood glucose concentration near the set point.

16 Plants produce several chemicals known as plant growth substances that are involved in the control of growth and responses to environmental changes. Auxin is synthesised mainly in growing tips of shoots and roots, and appears to be involved in preventing the growth of lateral buds when an intact and active apical bud is present. Gibberellin is synthesised in young leaves and in seeds. It stimulates growth of stems and germination of seeds such as those of wheat and barley. Abscisic acid is synthesised by any cells in a plant that contain chloroplasts or amyloplasts, especially in stress conditions. The presence of large concentrations of abscisic acid in leaves causes stomata to close.

### 1. End-of-chapter questions

1 Which of the following is an incorrect statement about the endocrine system?

- A All hormones bind to receptors on the cell surface of their target cells.
- B Endocrine glands are ductless.
- C Endocrine glands secrete hormones into the blood.
- D Hormones are transported in the blood plasma.

2 Glucose is small enough to be filtered from the blood in glomeruli in the kidney, but is not normally found in the urine. This is because glucose is:

- A reabsorbed in distal convoluted tubules
- B reabsorbed in proximal convoluted tubules
- C reabsorbed along the whole length of the nephrons
- D respired by cells in the kidney

3 Which of the following is responsible for saltatory conduction in myelinated neurones?

- A axon membranes
- B nodes of Ranvier
- C Schwann cells
- D voltage-gated channel proteins

4 Which of the following correctly identifies the effects of the three plant hormones, abscisic acid (ABA), auxin and gibberellin?



	Abscisic acid	Auxin	Gibberellin
A	apical dominance	stomatal closure	stem elongation
B	stimulates synthesis of amylase in seed germination	stem elongation	apical dominance
C	stomatal closure	apical dominance	stimulates synthesis of amylase in seed germination
D	stem elongation	apical dominance	stomatal closure

5 The figure shows the changes in potential difference across the membrane of a neurone over a period of time. The membrane was stimulated at time A and time B with stimuli of different intensities.

a Stimulus B resulted in an action potential. Describe what is occurring at C, D and E. [6]

b Suggest why stimulus A did not result in an action potential being produced whereas stimulus B did.

[2]

[Total: 8]

[Cambridge International AS and A Level Biology 9700104, Question 8, October/November 2007]

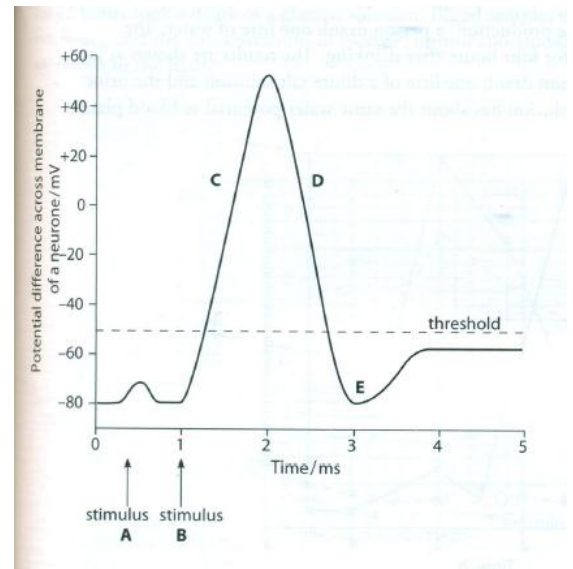

6 a Explain the meaning of the term excretion. [3]

b The figure is a photomicrograph of part of the kidney.

i Name A, B, C and D. [4]

ii Identify the region of the kidney shown in the figure and give a reason for your identification. [2]

iii Calculate the actual maximum width of the structure labelled A. Show your working. [2]

[Total: 11]

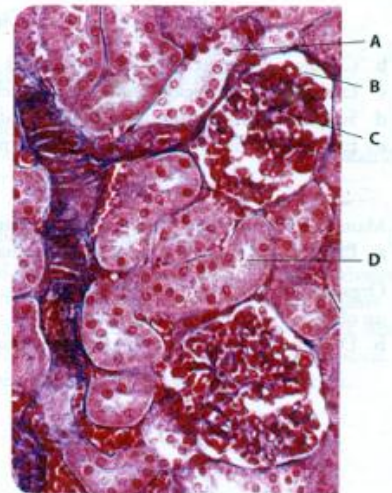
Magnification:  $\times 180$ 

7 The control of the water content of the blood is an example of homeostasis.

a Name the part of the body that monitors the water potential of the blood. [1]

In an investigation of the factors that influence urine production, a person drank one litre of water. The person's urine was collected at half-hourly intervals for four hours after drinking. The results are shown as line A on the figure. On the following day, the same person drank one litre of a dilute salt solution and the urine was collected in the same way (line B). Dilute salt solution has about the same water potential as blood plasma.

**b** Calculate how much urine was produced in the two hours after drinking the litre of water. [1]

**c** Explain why the person produced so much urine after drinking the litre of water. [4]

**d** Suggest why the results during the second day were so different from those on the first day. [2]

**e** Explain why negative feedback, and not positive feedback is involved in homeostatic mechanisms.

**[Total: 13]**

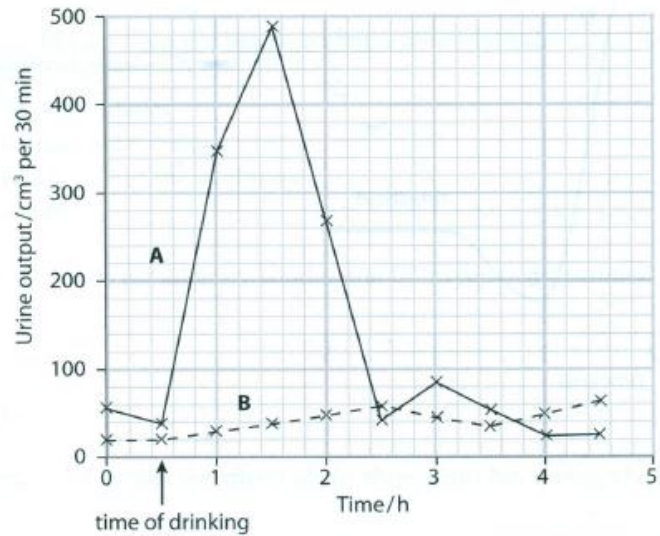

**8** Mammals have internal communication systems for signalling between cells.

**a** Explain why animals such as mammals have internal communication systems. [4]

Organs that secrete substances through ducts are known as exocrine glands. Most of the pancreas is made up of exocrine tissue. The rest, about 2%, is endocrine tissue which secretes insulin and glucagon.

**b** Describe the structure of the endocrine tissue in the pancreas. [5]

An investigation was carried out to determine the response of pancreatic cells to an increase in the glucose concentration of the blood. A person who had been told not to eat or drink anything other than water for 12 hours took a drink of a glucose solution. Blood samples were taken from the person at one hour intervals for five hours, and the concentrations of glucose, insulin and glucagon in the blood were determined. The results are shown in the figure.

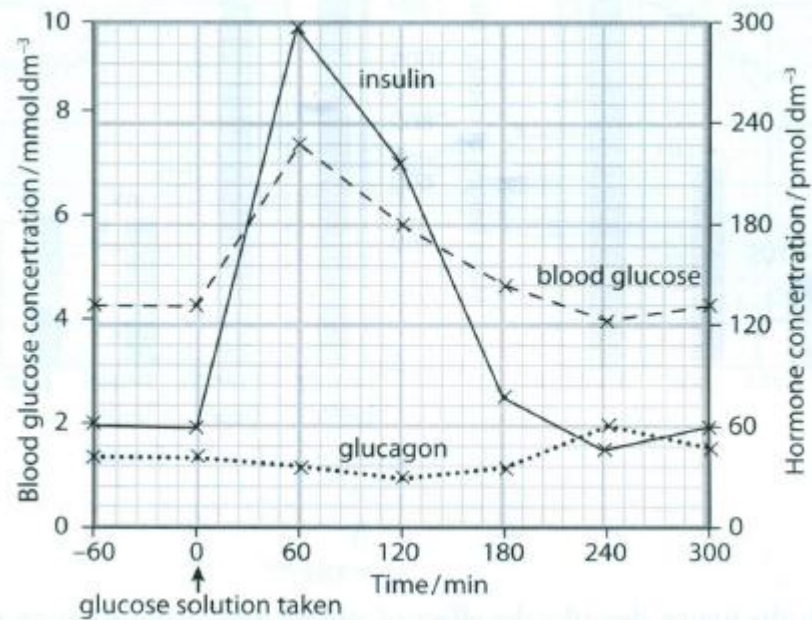

- c** i Explain why the person was told not to eat or drink anything other than water for 12 hours before having the glucose drink. [3]
- ii Use the information in the figure to describe the response of the pancreatic cells to an increase in the glucose concentration. [4]
- iii Outline the role of insulin when the glucose concentration in the blood increases. [5]

**[Total: 21]**

**9** Gibberellin is a plant growth regulator.

- a** Outline the role of gibberellin in the germination of seeds such as those of wheat and barley. [5]

In an investigation of the effects of gibberellin, plants of short-stemmed and long-stemmed varieties of five cultivated species were grown from seed. The young plants of each species were divided into two groups. One group of plants was sprayed with a solution of gibberellin each day. A control group was sprayed with the same volume of water. After eight weeks, the stem length of each plant was measured and means calculated for each group of plants. A statistical test was carried out to determine whether the difference between the treatments for each species was significant.

The results are shown in the figure. The p value for each species is given.

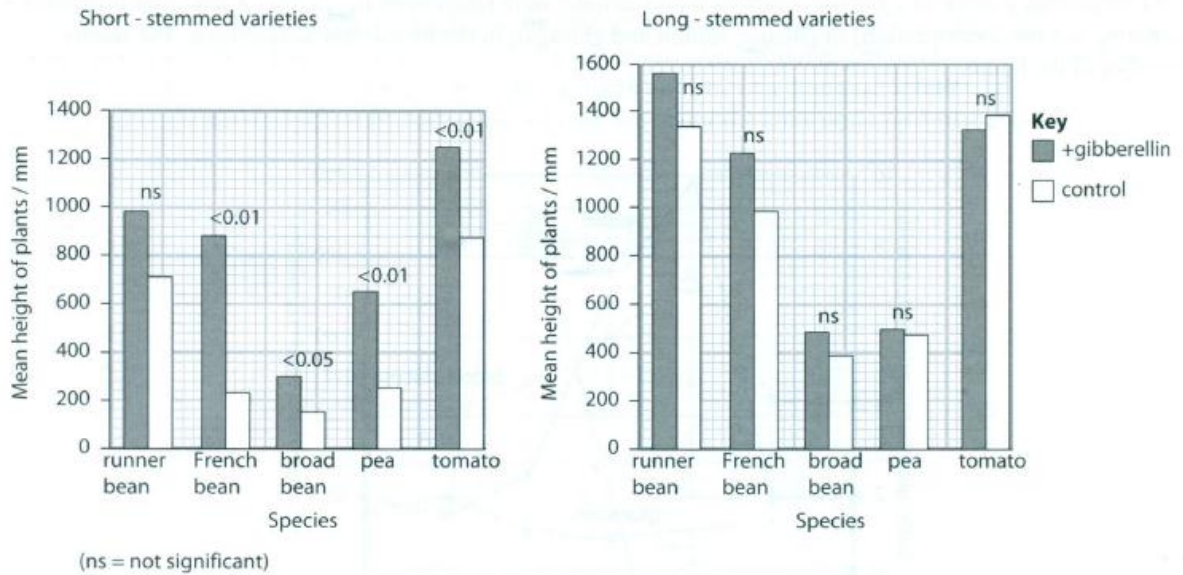

b Using the information in the figure, describe the effect of adding gibberellin solution to the two varieties of the five species. [5]

c Explain why the short-stemmed variety of pea showed a more significant growth in height when treated with gibberellin than the long-stemmed variety. [3]

d Suggest the advantages of cultivating crops of short-stemmed varieties of peas and beans rather than long-stemmed varieties. [3]

[Total: 16]

**10** Abscisic acid (ABA) is a weak acid. Its structure can be represented as ABA-H. It dissociates into positively charged H<sup>+</sup> ions (protons) and negatively charged ABA<sup>-</sup> ions as shown:



The following observations have been made by scientists:

light stimulates proton (H<sup>+</sup> ion) uptake into the grana of chloroplasts;  
ABA-H can diffuse into and out of chloroplasts, but ABA<sup>-</sup> cannot.

This information is summarised in the figure.

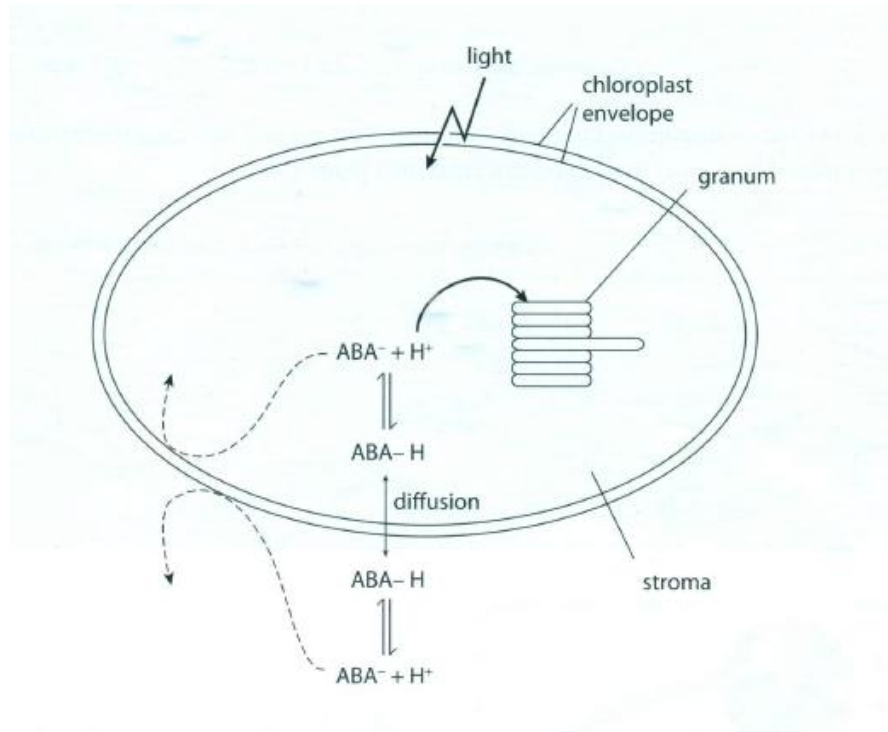

- a** Using all the information provided, predict what happens to the pH in the stroma in the light. [1]
- b i** When light shines on the chloroplast, dissociation of ABA-H is stimulated. Explain why this happens. [2]
- ii** Explain the effect that this will have on diffusion of ABA-H into or out of the chloroplast. [2]

When the mesophyll cells of leaves become dehydrated, some of the ABA stored in the chloroplasts is released into the transpiration stream in the apoplast,

**c** ABA travels in the apoplast pathway to the guard cells. Explain why this is an advantage when the leaf is dehydrated. [2]

[Total: 7]

- 11 a** Explain how a nerve impulse is transmitted along a motor neurone. [9]
- b** Describe how an impulse crosses a synapse. [6]

[Total: 15]

- 12 a** Describe a reflex arc and explain why such reflex arcs are important. [7]
- b** Describe the structure of a myelin sheath and explain its role in the speed of transmission of a nerve impulse. [8]

[Total: 15]

[Cambridge International AS and A Level Biology Paper 41, Question 10, October/November 2009]

- 13 a** Compare the roles of the endocrine and nervous systems in control and coordination in animals. [8]

**b** Describe the part played by auxins in apical dominance in a plant shoot. [7]

[Total:15]

[Cambridge International AS and A Level Biology 9700/04, Question 10, May/June 2008]

## 2. End-of-chapter answers

Cambridge International Examinations bears no responsibility for the example answers to questions taken from its past question papers which are contained in this publication.

1 A 2 B 3 B 4 C

**5 a** C: depolarisation/the inside of the membrane becomes more positive/less negative; sodium ions/Na<sup>+</sup>, flow in;  
 D: repolarisation/inside of the membrane becomes more negative/less positive; potassium ions/K<sup>+</sup>, flow out;  
 E: hyperpolarisation/refractory period; more negative than resting potential; [6]

**6 a** excretion: removal from the body; of waste products of metabolism; carbon dioxide/nitrogenous waste/urea/uric acid/ any other example; substances in excess of requirements; water/salts/sodium ions/potassium ions/any other example; [max. 3]

**b i** A: distal convoluted tubule;  
 B: Bowman's capsule;  
 C: glomerulus/capillary;  
 D: proximal convoluted tubule; [4]

**ii** cortex; glomeruli/convoluted tubules, are only found in the cortex; [2]

$$\begin{aligned}
 \text{iii} \quad \text{distance} &= 10\text{mm} \\
 &= 10\,000\ \mu\text{m} && [2] \\
 \text{actual distance} &= \frac{10\,000}{180} && [\text{Total: 11}] \\
 &= 56\ \mu\text{m}
 \end{aligned}$$

**7 a** hypothalamus; [1]

**b** 1555 cm<sup>3</sup> (or any answer within the range 1150 to 1160 cm<sup>3</sup> or equivalent in dm<sup>3</sup>); **[1]**

**c** any four from:

water was absorbed into the blood;  
 water increases the water potential of the plasma;  
 any effect of an increase in water potential of the plasma on, cells/tissues, e.g. water enters cells by osmosis/cells will swell/decreases efficiency of reactions inside cells/cells may burst; osmoreceptors detect increase in water potential; do not, secrete/release, ADH; collecting ducts remain impermeable to water; excess water lost in urine; until water potential returns to normal/  
 set point;

**[max. 4]**

**d** (after absorption of dilute salt solution) no change in water potential of blood plasma; water and salt is not lost in the urine, so must remain in the body; giving an increase in volume, of blood or body fluids; body tolerates changes in blood volume, but not its water potential; **[max. 2]**

**e** homeostasis is maintenance of constant internal conditions;

**negative feedback:** a deviation from the set point;

is detected by a receptor; a control centre instructs effector to carry out an action; to reverse the change/return factor to set point;

**positive feedback:** any (small) deviation in a factor leads to an increase in the change (not a reversal); e.g. opening of voltage-gated sodium ion channels in rising phase of action potential; **[max. 5]**

**[Total: 13]**

**8 a** animals are multicellular/complex organisms;

cells are long distances apart;

coordination;

of cells/tissues/organs, so that they work together;

regulation of internal environment/ refer to homeostasis;

response to, changes in the environment/external stimuli;

any

example;

**4]**

**[max.**

**b** islets of Langerhans;

small groups of cells;

scattered among the exocrine tissue;

blood spaces/ capillaries, in between the cells;

$\alpha$  cells;

$\beta$  cells;

cells full of vesicles containing (molecules of), hormones/protein;

cells with rough endoplasmic

reticulum;

**[max. 5]**

**c i** glucose concentration may already be high;  
 if person had eaten within 12 hours;  
 effect of sudden increase would not be seen/so there was a sudden increase;  
 may already be a high concentration of  
 insulin; **[max. 3]**

**ii**  $\beta$  cells secrete insulin; concentration of insulin increases over first hour after taking the  
 glucose solution;  
 insulin concentration increases from 60 to 300 pmol dm<sup>-3</sup> ;  
 $\alpha$  cells do not secrete glucagon;  
 glucagon concentration, remains constant/decreases;  
 from 42 to 36 pmol dm<sup>-3</sup>  
 ; **[max. 4]**

**iii** insulin: stimulates, liver/muscle, cells;  
 increase in uptake of glucose from the blood;  
 stimulates enzymes; to increase conversion of glucose to glycogen;  
 brings about a decrease in the blood glucose  
 concentration; **[5]**

**[Total: 21]**

**9 a** gibberellin secreted by embryo;  
 stimulates cells in the aleurone layer;  
 stimulates protein synthesis;  
 to make amylase;  
 to break down starch in the endosperm;  
 mobilises glucose;  
 for respiration;  
 to provide energy for  
 germination; **[max. 5]**

**b** gibberellin increases the mean length of the stem in the short-stemmed varieties of  
 all species;  
 figures for any one species;  
 increase is significant in all but one species;  
 gibberellin increases the mean length of the stem in the long-stemmed varieties of  
 four of the species; not tomato;  
 increases are not significant; **[max. 5]**

**c** short-stemmed plants do not make (much) gibberellin;  
 (because) they do not have the allele for the enzyme that makes gibberellin;  
 long-stemmed variety has dominant allele for gibberellin synthesis;  
 gibberellin supplied each day promotes growth of  
 stems; **[max. 3]**

**d** less energy used for growth of stem; (therefore) more energy in, peas/beans/seeds;  
 plants do not need (as much) support; less likely to be damaged by wind; less plant  
 material to harvest/less wastage at harvest ; **[max. 3]**

**[Total: 16]**



**10****a** increases;**[1]**

**b i** concentration of protons in the stroma decreases (as enter grana); shifts equilibrium to the right;

**[2]**

**ii** increases diffusion into the chloroplast; as concentration of ABA-H decreases; so maintaining a concentration gradient into the chloroplast;

**[max. 2]**

**c** ABA stimulates closure of stomata; less water vapour is lost;

**[2]****[Total: 7]****11 a** resting potential;anything in the range  $-60$  to  $-70$  mV;sodium-potassium pump uses ATP to pump  $\text{Na}^+$  out and  $\text{K}^+$  in;many anions inside the neurone; resting potential is due to leakage of  $\text{K}^+$  out;

action potential is depolarisation of membrane;

up to  $+40$  mV;

opening of voltage-gated sodium ion channels/ sodium ions flow in;

closing of voltage-gated sodium ion channels;

voltage-gated potassium ion channels open;

 $\text{K}^+$  flow out; resting potential restored;

local circuits depolarise next part of, membrane/ axon;

refractory period ensures impulse does not travel backwards;

saltatory conduction in myelinated neurones;

action potential only at nodes of Ranvier;

**[max. 9]**

**b** action potential arrives at presynaptic membrane; voltage-gated calcium ion channels open; calcium ions enter to stimulate vesicles to move to membrane;

vesicles fuse with membrane/ exocytosis, to release (named) neurotransmitter;

(named) neurotransmitter diffuses across (synaptic) cleft;

binds with receptor on postsynaptic membrane;

stimulates opening of sodium ion channel proteins;

sodium ions flow in through postsynaptic membrane/depolarisation of postsynaptic membrane;

**[max. 6]****[Total: 15]****12 a** reflex arc: to max 5 – *these points may be on a diagram:*

strong stimulus in receptor/AW;

action potential/impulses, along sensory neurone;

dorsal root of spinal nerve; into spinal cord; synapse with intermediate neurone;

(then) motor neurone;

action potential/impulses, to effector;

action potential/impulses, to brain;

response; e.g. knee jerk;

other points which may also be given on a diagram: fast/immediate;

stops/limits, damage/danger;  
 automatic/no conscious thought;  
 innate/stereotyped/instinctive;

[max. 7]

**b** myelin sheath: Schwann cells;

wrap around axon;

sheath mainly lipid;

(sheath) insulates axon (membrane);

$\text{Na}^+ / \text{K}^+$ , cannot pass through sheath/can only pass through membrane at nodes;

depolarisation (of axon membrane) cannot occur where there is sheath/only at nodes of Ranvier;

local circuits between nodes;

action potentials 'jump' between nodes;

saltatory conduction;

increases speed/reduces time, of impulse transmission;

up to  $100 \text{ m s}^{-1}$  ;

speed in non-myelinated neurones about  $0.5 \text{ m s}^{-1}$

[max. 8]

[Total: 15]

**13 a** endocrine system: uses hormones;

which are chemical messengers/chemicals that transfer messages;

secreted/released, into blood by ductless glands;

influence target/organs/cells;

which have receptors on cell membranes;

an example of named hormone and effect;

e.g. insulin, stimulates decrease in blood glucose concentration nervous system: use impulses/action potentials;

not electrical, signals/current along neurones/nerve fibres;

not nerves synapse (at target cell)/neuromuscular junction;

named neurone;

e.g. receptor/sensory/motor/ eff ector/intermediate/relay

**differences between the two systems:** endocrine has slow effect/nervous is fast;

endocrine has long-lasting effect/nervous has short-term effect;

endocrine has widespread effect/nervous has very localised effect;

any other detail;

e.g. extra detail of synapse, such as

neurotransmitters

[max. 8]

**b auxins:** indole 3-acetic acid (IAA/plant growth regulator);

synthesised in, growing tips/apical buds/meristems;

moves by diffusion;

from cell to cell;

also, by mass flow/in phloem;

stimulates cell elongation;

not cell enlargement inhibits, side/lateral, buds/ growth accept inhibits branching plant grows, upwards/ taller;

accept stem elongates interaction between IAA and other plant growth regulators;

**AVP;** e.g. role of abscisic acid (ABA) and lateral bud inhibition

**AVP;** e.g. cytokinins antagonistic to IAA/ gibberellins enhance IAA [max. 7] [Total: 15]

## CHAPTER 17 – INHERITANCE

### #109 Gametogenesis

Diploid organisms contain pairs of homologous chromosomes.

Homologous chromosomes:

- a pair of chromosomes in a **diploid cell**
- same structure, genes, loci
- pair together to form **bivalent** during the first division of meiosis

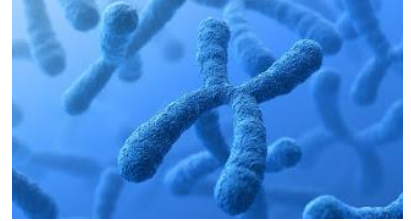

Haploid: possesses **1** complete set of chromosomes: **n**

Diploid: possesses **2** complete sets of chromosomes: **2n**

Meiosis: reduction division

- number of chromosomes **would double** without meiosis
- introduces **genetic variation** → mutation

### Gametogenesis in mammals

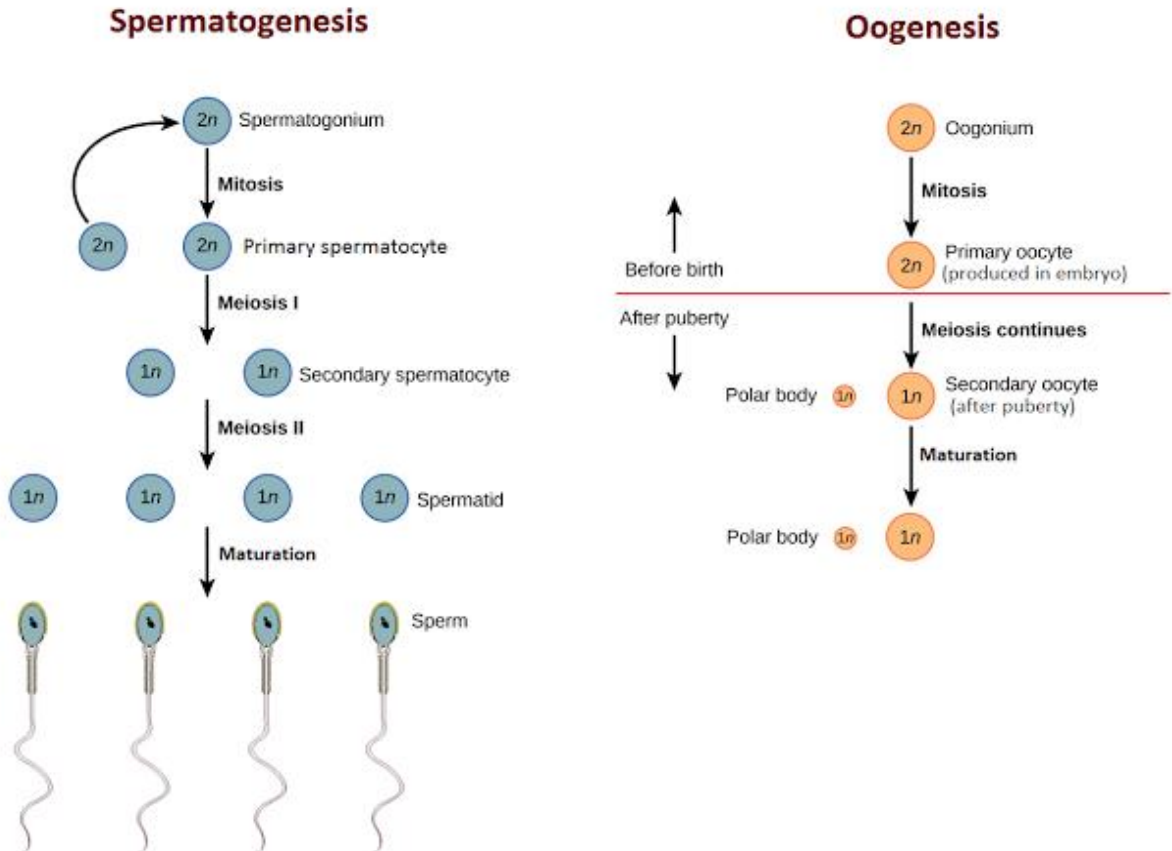

**Gametogenesis in plants**

**Development of pollen grain**

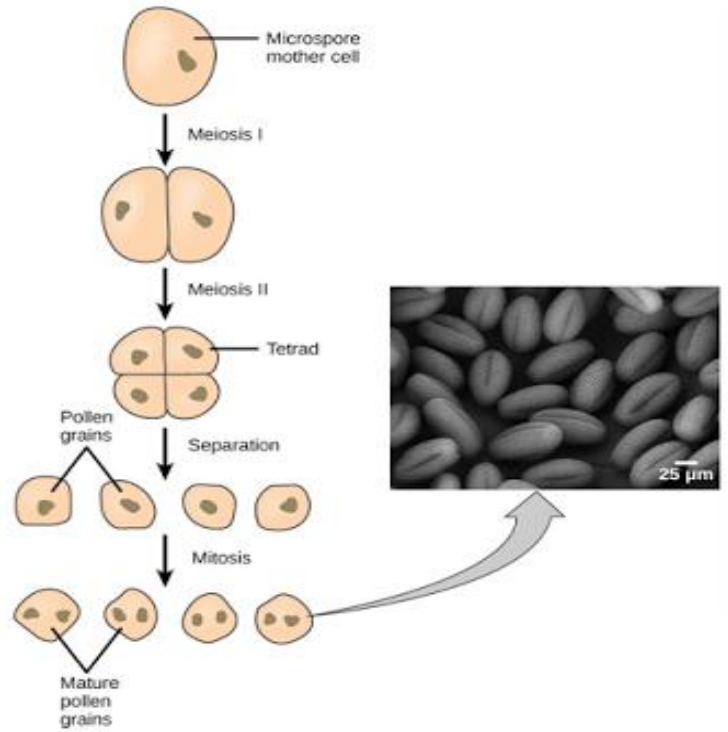
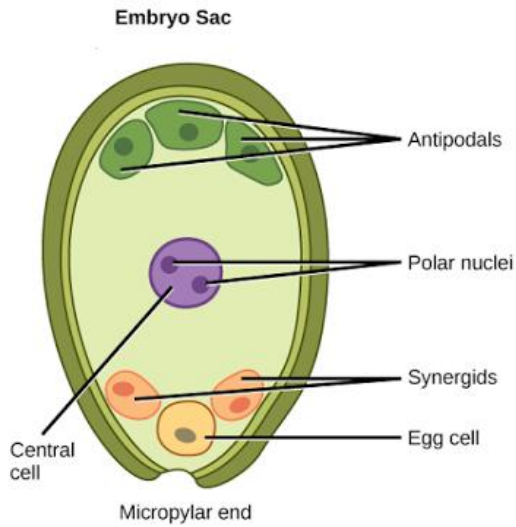

**Development of embryo sac**

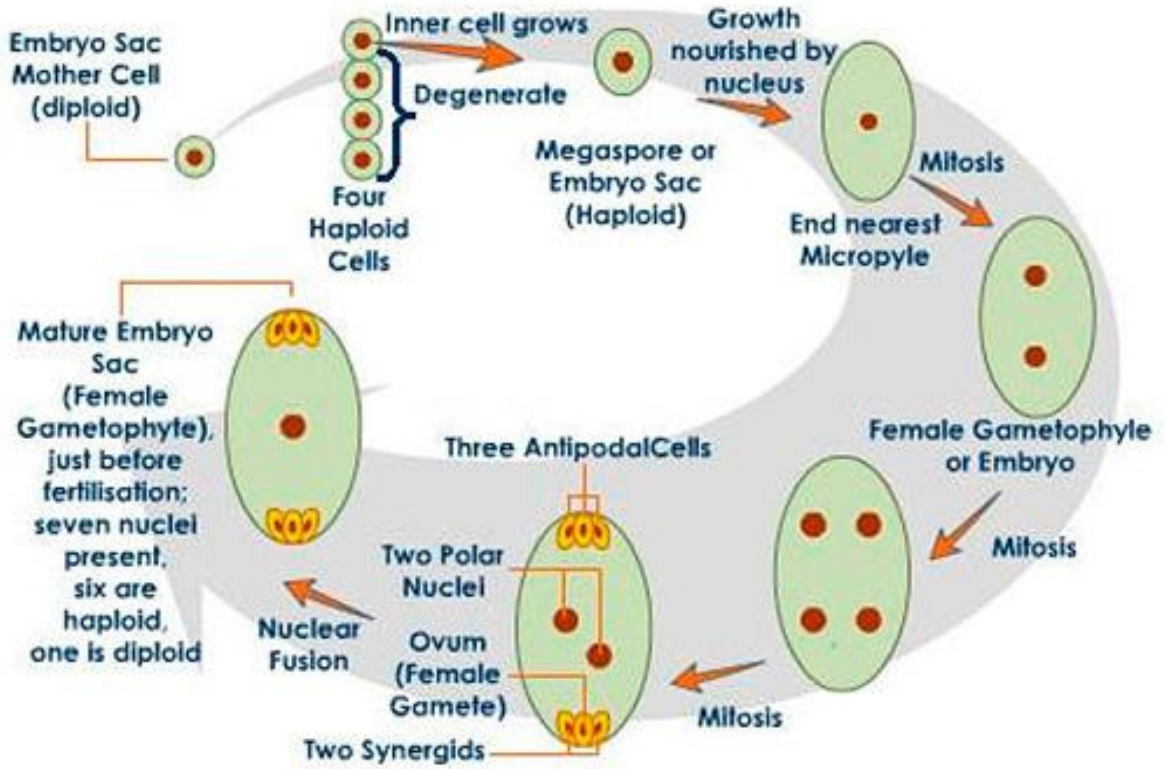

## #110 Meiosis

Meiosis involves **two divisions**, called meiosis I and meiosis II.



### Meiosis I:

- **reduction** division
- resulting in 2 daughter nuclei (haploid) **half** the number of chromosomes of the parent nucleus

### Meiosis II:

- behaves like **mitosis**
- results in total of **4 haploid nuclei**

### Meiosis I

#### 1. Prophase I

- **centrosomes divide** and move to opposite poles of nucleus --> spindle formation
- homologous chromosomes pair up --> **crossing over** and form **bivalents**
- nucleus disappears
- nuclear envelope breaks down

#### 2. Metaphase I

- bivalents **line up** at equator
- spindles attach to centromere

#### 3. Anaphase I

- whole chromosomes move to **opposite poles** of spindle
- pulled by **microtubules**

#### 4. Telophase I

- nuclear envelope reforms
- nucleolus reform

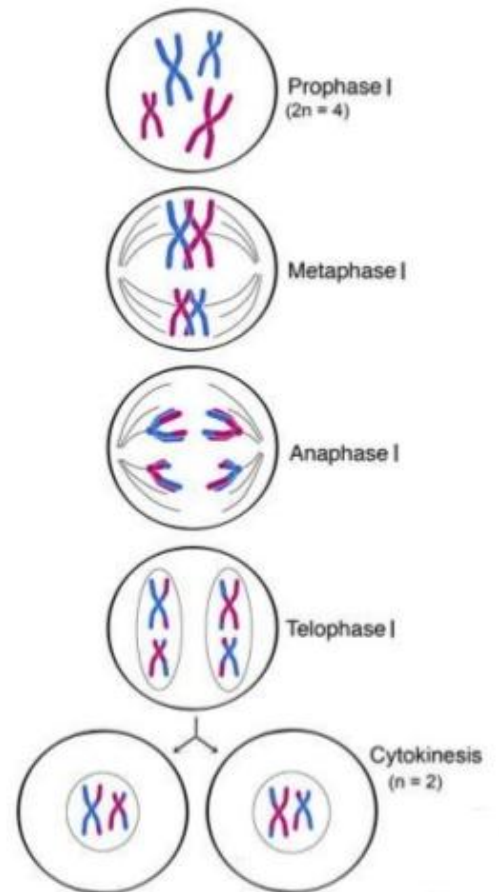

## Meiosis II

### 5. Prophase II

- nuclear envelope breaks down
- nucleolus disappears
- centrosomes and centrioles **replicate**; move to opposite poles

### 6. Metaphase II

- chromosomes **line up** separately across equator of spindle

### 7. Anaphase II

- centromeres divide
- spindle microtubules pull **chromatids** to opposite poles

### 8. Telophase II

- **4 haploid** daughter cells

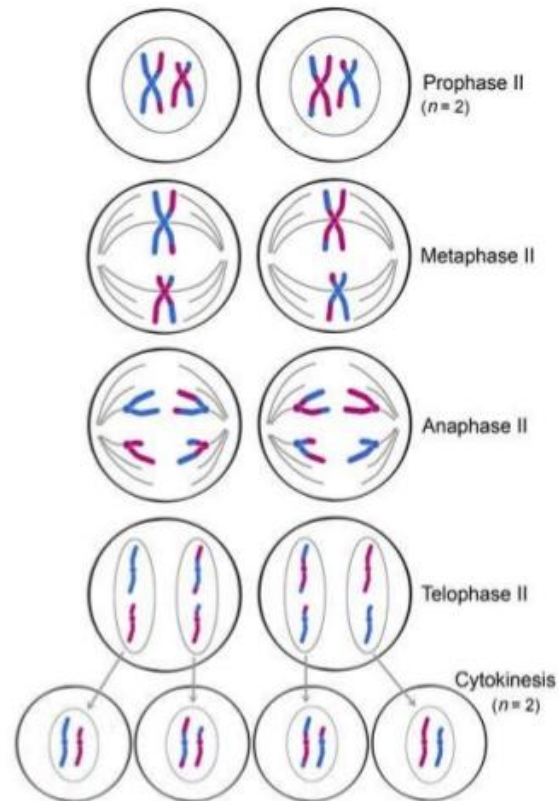

## How meiosis causes variation

### Crossing over:

- **prophase of meiosis I**
- chromatids of 2 homologous chromosomes **break and rejoin** --> part of one chromatid swaps places with the same part of the other (exchange of gene loci between a maternal and paternal chromatid)
- chiasmata: point where crossing over occurs

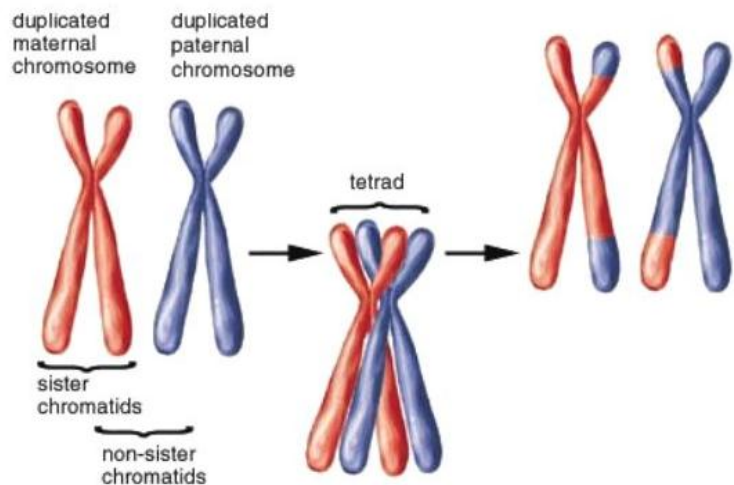

Recombinant organisms result from crossing over and so 'recombines' the characteristics of the parent organisms. The cross over value is the percentage of offspring that belong to the recombinant class.

### Independent assortment:

- **random alignment** of bivalents on the equator during meiosis I
- different alleles of genes on different chromosomes may end up in **any combination** in gametes

## #111 Terms for human genetics

Studies of human genetic conditions have revealed the links between genes, enzymes and the phenotypes.



- **gene:** length of DNA that codes for a particular protein/polypeptide
- **locus:** position at which a particular gene is found on a particular chromosome; same gene on same locus
- **allele:** particular variety of a gene
- **dominant:** the allele whose effect on the phenotype of a heterozygote is identical to its effect on a homozygote
- **recessive:** the allele that is only expressed when no dominant allele is present
- **codominant:** alleles that both have an effect on the phenotype of a heterozygous organism
- **linkage:** the presence of 2 genes on the same chromosome so that they tend to be inherited together and do not assort independently
- **test cross:** a genetic cross in which an organism showing a characteristic caused by a dominant allele is crossed with an organism that is homozygous recessive -- > phenotype of offspring is a guide to whether the 1st organism is homozygous or heterozygous
- **F1:** generation of offspring produced from homozygous dominant x homozygous recessive genotype
- **F2:** generation of offspring produced from cross between 2 F1 organisms
- **phenotype:** organisms' characteristics; often resulting from an interaction between its genotype and the environment
- **genotype:** alleles possessed by an organism

Genotype	Phenotype
Hb <sup>A</sup> Hb <sup>A</sup>	normal
Hb <sup>A</sup> Hb <sup>S</sup>	normal, but with sickle cell trait (carrier)
Hb <sup>S</sup> Hb <sup>S</sup>	sickle cell anaemia

- **homozygous:** having 2 identical alleles of a gene
- **heterozygous:** having 2 different alleles of a gene

## #112 Genetic diagrams

Patterns of **inheritance** are explained by using **genetic diagrams**. Genetic diagrams are the standard way of showing the genotypes of offspring that might be expected from 2 parents.



In sexual reproduction, haploid gametes are made following meiosis. Each gamete contains 1 pair or chromosomes = one copy of each gene.

**Monohybrid inheritance:**  
inheritance of **1 gene**

**Genetic Diagram**

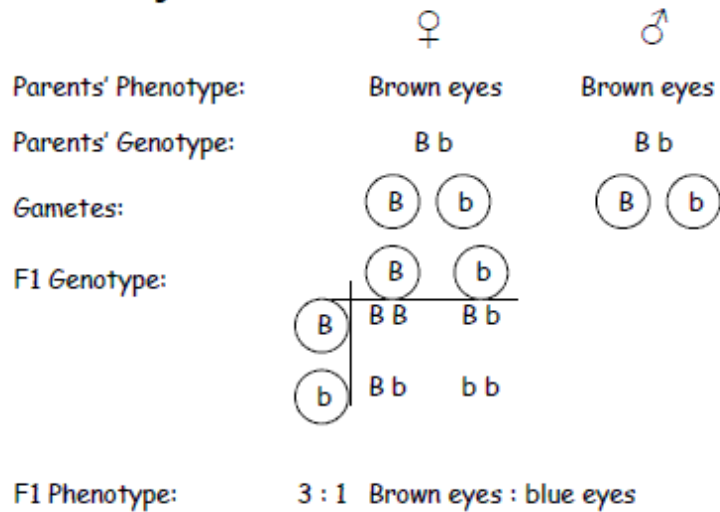

Genotype	Phenotype
$C^R C^R$	red coat
$C^R C^W$	pink coat
$C^W C^W$	white coat

**Codominance:** alleles both have an **effect** on the **phenotype** of a heterozygous organism.

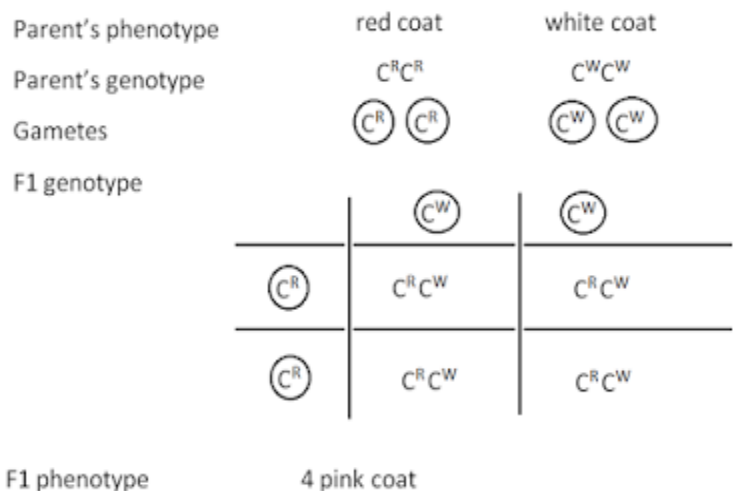



**Multiple alleles:** As the name suggests, when a gene has **more than 2** alleles

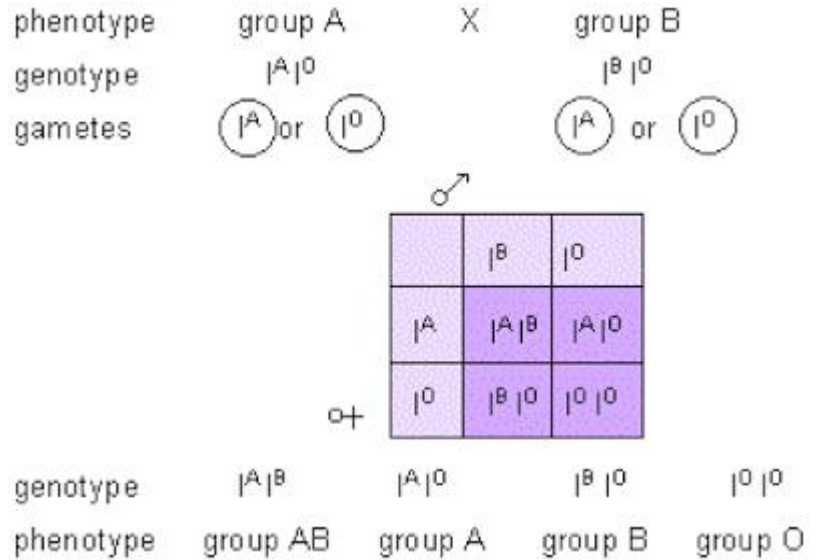

**Sex linkage** - a sex linked gene is a gene that is **present on the X chromosome** and not the Y chromosome  
e.g.: colour blindness

A : normal allele

a: allele for colour blindness

Parent's phenotype	normal vision	normal vision
Parent's genotype	$X^A X^a$	$X^A Y$
Gametes	$X^A$ $X^a$	$X^A$ $Y$

F1 phenotype

	$X^A$	$X^a$
$X^A$	$X^A X^A$ female normal	$X^A X^a$ female normal
$Y$	$X^A Y$ male normal	$X^a Y$ male colour blind

**Dihybrid inheritance:** inheritance of **2 genes**

**Independent assortment** of homologous chromosomes during meiosis I results in a variety of genotypes in the gametes formed.

ratio **9 : 3 : 3 : 1** of dihybrid cross between 2 heterozygotes

- alleles of both genes show complete dominance
- genes are on different chromosomes

**Interactions between loci** - where **different loci** interact to affect **one phenotypic character**

e.g.: alleles on 2 separate loci both affect the colour of feathers on a bird

**Autosomal linkage**

Genes are linked when two or more genes are **present on the same chromosome** => they tend to be **inherited together** and do not assort independently.

e.g.: Drosophila colour gene and shape gene  
Body colour gene:

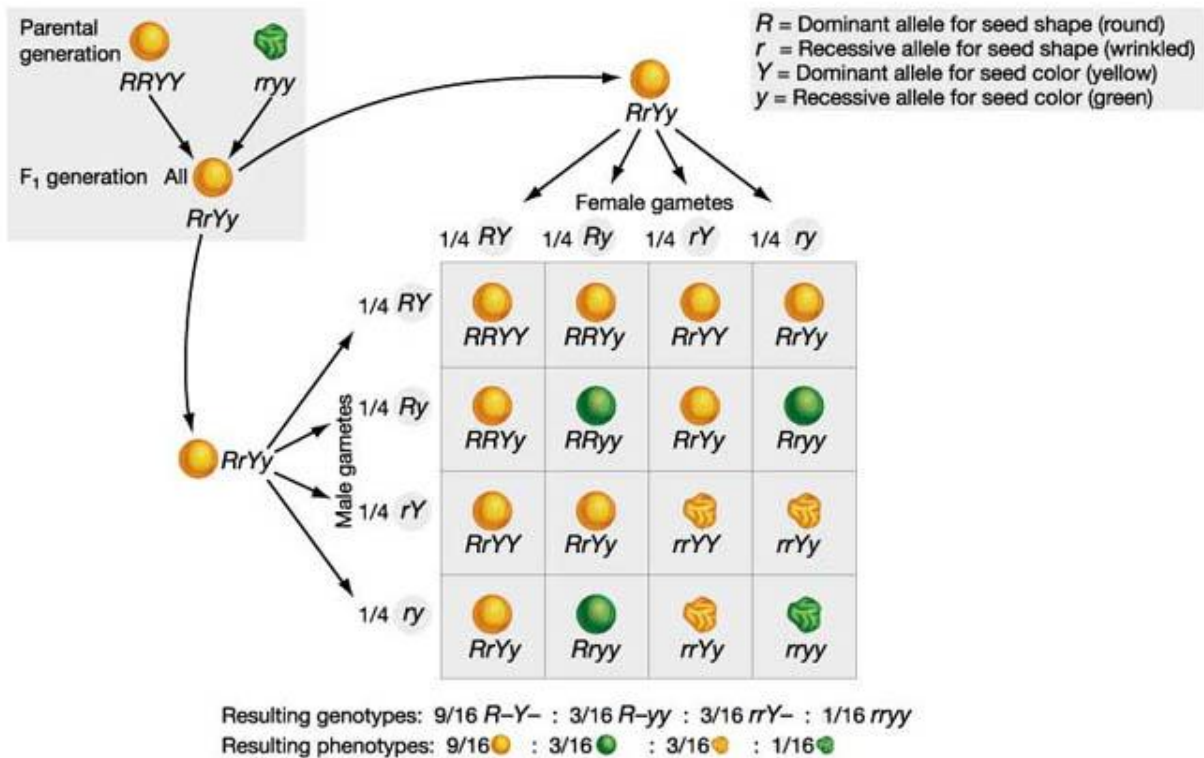

- $E$  = allele for striped body
- $e$  = allele for ebony body

Antennal shape gene:

- $A$  = allele for normal antennae
- $a$  = allele for aristopedia antennae

EEAA = genes not on same chromosome

(EA)(EA) = genes on the same chromosome

- Parental genotype (EA)(EA) => gametes EA only
- Parental genotype (EA)(ea) => gametes EA or ea
- Parental genotype (ea)(ea) => gametes ea only

## #113 Genetic mutations

A mutation is an **unpredictable change** in the genetic material of an organism.

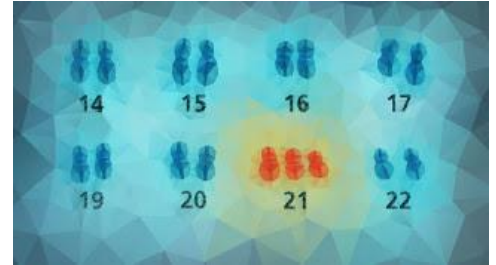

**Gene mutation:** change in the structure of a DNA molecule, producing a **different allele** of a gene.

**Chromosome mutation:** changes in the structure or number of **whole chromosomes** in a cell.

**Sources/ mutagens :** increase chances of a mutation occurring

- random
- environmental factors (ionising radiations alpha, beta, gamma; UV radiation; chemicals)

### Gene mutations

Types:

- base substitution
- base addition
- base deletion

Consequences:

- **silent:** same amino acid; a mutation that has no apparent effect on the organism
- **missense:** different amino acid; no apparent effect
- **nonsense:** introduce a 'stop' triplet
- **frame shift:** protein that is made becomes totally useless

Original sequence



Base substitution

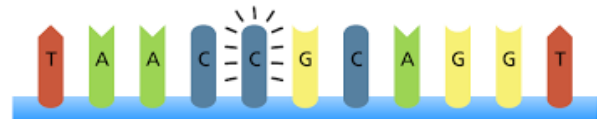

Base addition

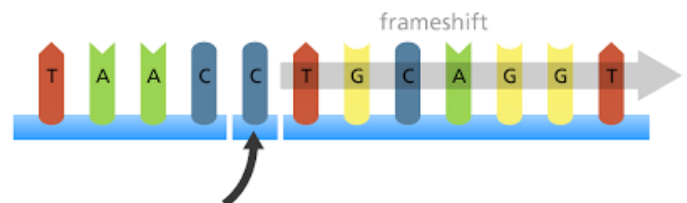

Base deletion

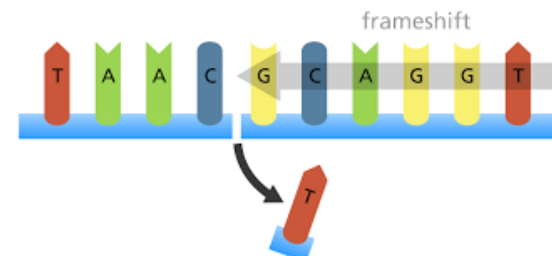

	substitution	addition	deletion
silent	×		
missense	×		
nonsense	×	×	×
frame shift		×	×

Base additions and deletions usually have a very significant effect on the structure and therefore the function of the polypeptide that the allele codes for.

### 1. Sickle cell anaemia

Base **substitution** in the gene that codes for the amino acid sequence in the  $\beta$ -globin  
Glutamic acid --> valine; **Hb<sup>A</sup>** allele --  
> **Hb<sup>S</sup>** allele

Effects: Haemoglobin molecule becomes much less soluble

- molecules stick together and form **long fibres** inside red blood cells
- rbc are pulled out of shape, into a **half-moon** or sickle shape
- distorted cells become **stuck in small capillaries** and so cannot transport oxygen, block normal rbc's getting through

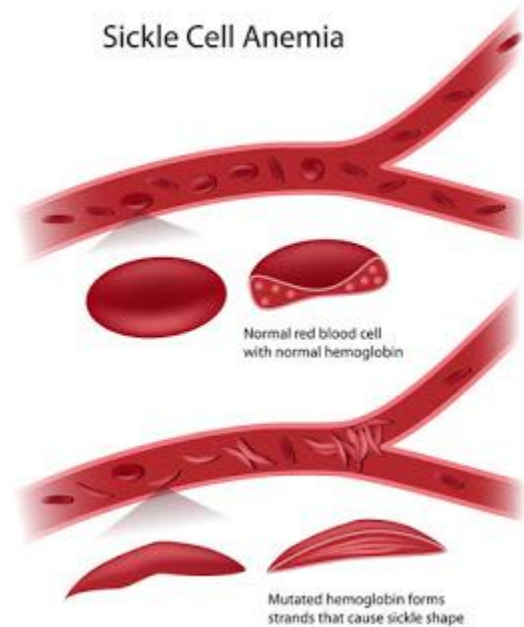

### 2. Albinism

- Classic form - **Autosomal recessive** mutation: individuals that are homozygous for the recessive allele show albinism
- Other forms - mutation at several loci; sex-linked

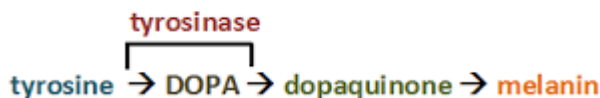

Mutation in the gene for **tyrosinase**:

- absence of tyrosinase
- presence of inactive tyrosinase

Effects:

- dark pigment **melanin** partially/totally missing from eyes, skin or hair
- poor **vision**; rapid, jerky eye movement; avoids bright light

### 3. Huntington's disease:

Mutation **inherited** as a **dominant allele**. The mutation is an unstable segment in a gene on chromosome 4 coding for a protein called huntingtin.

- Non-sufferers: small number of repeats of the triplet of bases CAG
- Sufferer: '**stutter**' - larger number of CAG  
repeats CAG CAG CAG CAG CAG CAG CAG

Effects:

- HD is a **neurological disorder** resulting in involuntary movements (chorea) and progressive mental deterioration.
- The age of onset is variable, but occurs most commonly in **middle age**.
- The more CAG stutters, the earlier the age of onset.

#### 4. Haemophilia

- Mutation is **sex-linked** (gene on the X chromosome)
- Gene codes for the production of protein for blood-clotting '**factor VIII**'

- H: dominant allele
- h: recessive allele - blood fails to clot properly



## #114 Gene control in prokaryotes (lac operon)

In both prokaryotes and eukaryotes, transcription of a gene is controlled by **transcription factors**.

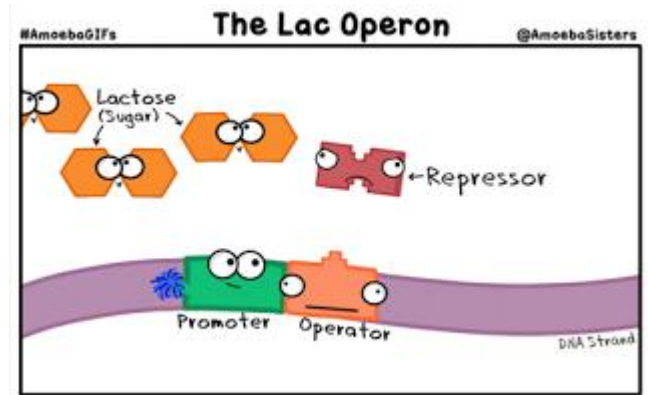

Transcription factors are:

- proteins that bind to a specific DNA sequence
- **control** the **formation of mRNA** --> control the flow of information from DNA to RNA

**Structural** genes code for **proteins required** by a cell.

**Regulatory** genes code for **proteins** that **regulate** the expression of other genes.

The synthesis of **repressible enzymes** can be prevented by binding a **repressor protein** to the operator (a specific site) on the bacterium's DNA.

The synthesis of **inducible enzymes** occur when its **substrate** is present.

### Prokaryotic lac operon

operon: a length of DNA making up a unit of gene expression in a bacterium.

The *lac* operon consists of a length of DNA with **operator** and **promoter** regions and a cluster of **3 structural genes**:

- *lacZ* - coding for  $\beta$ -galactosidase (hydrolyses lactose to glucose + galactose)
- *lacY* - coding for permease (allows lactose to enter cell)
- *lacA* - coding for transacetylase

Close to the promoter, although not part of the operon, is the **regulatory gene** for the *lac* operon.

### Lactose absent

- regulatory gene codes for **repressor protein**\*
- repressor binds to **operator region**, close to *lacZ*

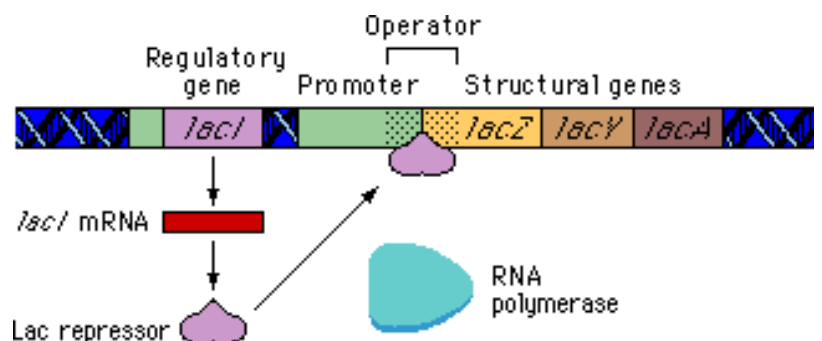

- RNA polymerase **can't bind** to DNA at promoter region
- **no transcription** of the 3 structural genes

\*repressor protein is allosteric (has 2 binding sites). The repressor binds to DNA with one site and binds to lactose with another site.

### Lactose present:

- lactose taken up by bacterium
- lactose **binds to repressor protein**, distorts shape and prevents it from binding to the operator region on the DNA (**closes DNA-binding site**)
- transcription no longer inhibited
- **mRNA produced** from 3 structural genes

This makes sure that the bacterium can produce  $\beta$ -galactosidase, permease and transacetylase only when **lactose is available** in the surrounding medium.

This **avoids waste of energy and materials**.

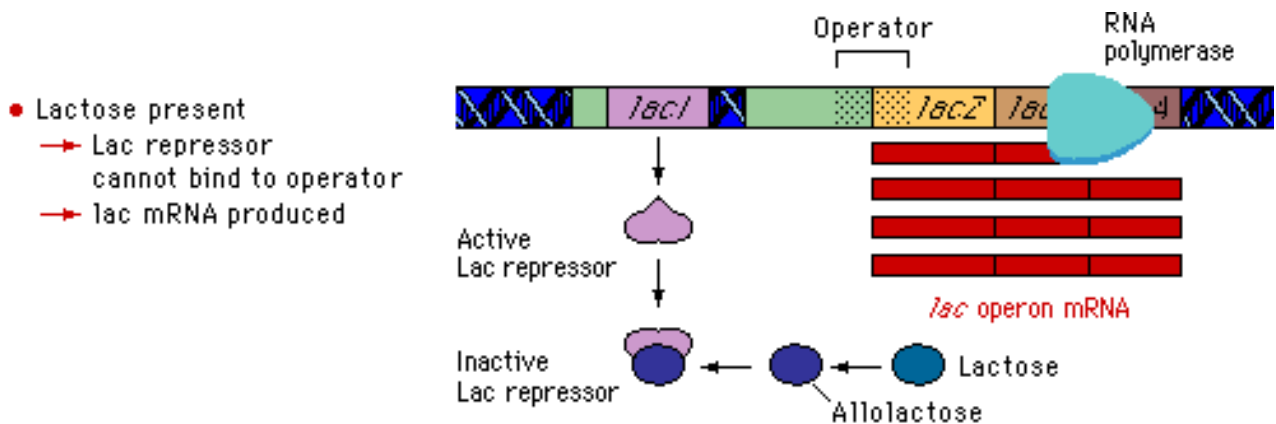

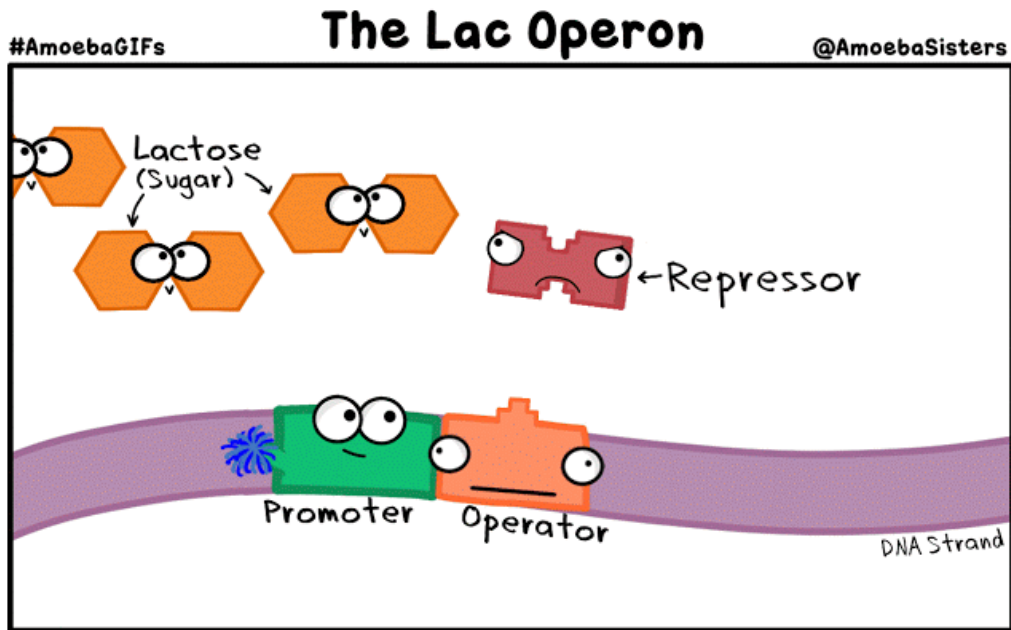

**Question 10a from 2016 specimen paper**

**10 (a)** Explain how the *lac* operon is involved in the metabolism of lactose in *Escherichia coli*. [9]

1. regulatory gene codes for repressor protein ;
2. (repressor protein) binds to operator region ;
3. (repressor protein) blocks promoter region ;
4. lactose binds to repressor protein which changes shape ;
5. (repressor protein with bound lactose) breaks away from operator region ;
6. promoter region now unblocked, so RNA polymerase binds to promoter region ;
7. structural genes transcribed ;
8. and translated ;
9. enzymes formed ;
10. ref. lactose permease and uptake of lactose from medium ;
11. ref.  $\beta$ -galactosidase and breakdown of lactose ;
12. into, glucose / galactose ;

[http://papers.gceguide.com/A%20Levels/Biology%20\(9700\)/9700\\_y16\\_sp\\_4.pdf](http://papers.gceguide.com/A%20Levels/Biology%20(9700)/9700_y16_sp_4.pdf)

[http://papers.gceguide.com/A%20Levels/Biology%20\(9700\)/9700\\_y16\\_sm\\_4.pdf](http://papers.gceguide.com/A%20Levels/Biology%20(9700)/9700_y16_sm_4.pdf)



## #115 Gene control in eukaryotes

Some genes are **transcribed** all the time to produce constitutive proteins; others are only '**switched on**' when their protein products are required.

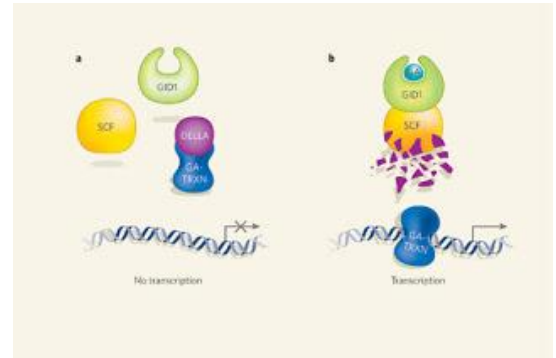

Transcription factors bind to the **promoter region** of a gene. This may increase or decrease the transcription of the gene. Their roles are to make sure that genes are expressed in the **correct cell** at the correct **time** and to the correct **extent**.

Effects of transcription factors:

- form part of the **protein complex** that binds to the promoter region of the gene
- **activate** appropriate genes in sequence
- determination of **sex** in animals
- allow **responses** to environmental stimuli
- regulate **cell cycle**, **growth** and **apoptosis**
- give **hormones** their effect

**Gibberellin** (a plant hormone) controls **seed germination** in plants such as wheat and barley by stimulating the **synthesis of amylase**.

- DELLA protein inhibits the binding of a transcription factor to the gene promoter PIF
- gibberellin causes the **breakdown of DELLA** protein
- gibberellin allows PIF to bind to its **target promoter**
- **transcription** of the gene can take place
- increases **amylase production**

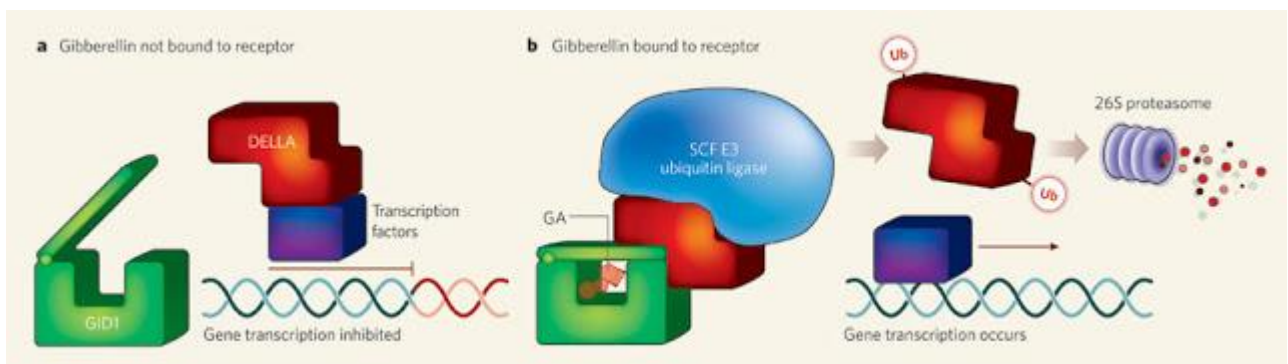

## #116 Summary of Inherited change

1 Meiosis consists of two divisions. The first division, **meiosis I**, separates the homologous chromosomes, so that each cell now has only one of each pair. The second division, meiosis II, separates the chromatids of each chromosome. Meiotic division therefore produces four cells, each with one complete set of chromosomes.

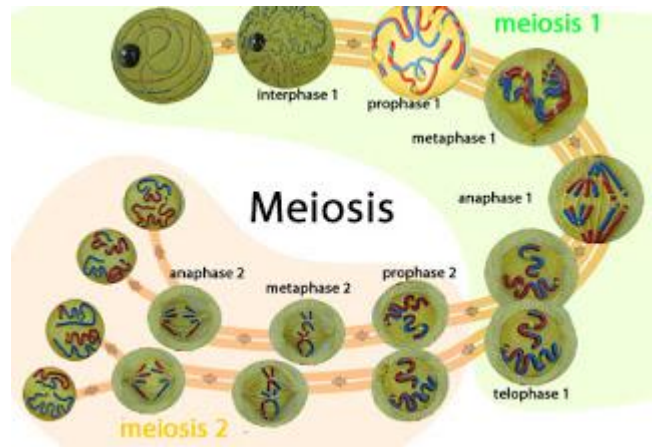

2 Diploid organisms contain two copies of each gene in each of their cells. In sexual reproduction, gametes are formed containing one copy of each gene. Each offspring receives two copies of each gene, one from each of its parents.

3 The cells produced by meiosis are genetically different from each other and from their parent cell. This results from independent assortment of the chromosomes as the bivalents line up on the equator during metaphase I, and also from crossing over between the chromatids of homologous chromosomes during prophase I.

4 Genetic variation also results from random fertilisation, as gametes containing different varieties of genes fuse together to form a zygote.

5 An organism's genetic constitution is its genotype. The observable expression of its genes is its phenotype.

6 Different varieties of a gene are called alleles. Alleles may show dominance, codominance or recessiveness. An organism possessing two identical alleles of a gene is homozygous; an organism possessing two different alleles of a gene is heterozygous. If a gene has several different alleles, such as the gene for human blood groups, these are known as multiple alleles.

7 The position of a gene on a particular chromosome is its locus.

8 A gene found on the X chromosome but not on the Y chromosome is known as a sex-linked gene.

9 The genotype of an organism showing dominant characteristics can be determined by looking at the offspring produced when it is crossed with an organism showing recessive characteristics. This is called a test cross.

10 Monohybrid crosses consider the inheritance of one gene. Dihybrid crosses consider the inheritance of two different genes.

11 The  $\chi^2$  test can be used to find out whether any differences between expected results and observed results of a genetic cross are due to chance, or whether the difference is significant.

12 The genotype of an organism gives it the potential to show a particular characteristic. In many cases, the degree to which this characteristic is shown is also affected by the organism's environment.

13 Mutation can be defined as an unpredictable change in the base sequence in a DNA molecule (gene mutation) or in the structure or number of chromosomes (chromosome mutation). New alleles arise by gene mutation. Gene mutations include base substitutions, deletions or additions. The HbS (sickle cell) allele arose by base substitution. Such mutations may affect the organism's phenotype.

### 1. End-of-chapter questions

1. A cell in the process of meiosis was seen to have a spindle with sister chromatids being drawn towards opposite poles of the cell. In what stage of meiosis was the cell?

- A anaphase I
- B anaphase II
- C metaphase I
- D metaphase II

2. All the offspring of a cross between pure-bred red-flowered and pure-bred white-flowered snapdragons were pink.

Two of these pink-flowered plants were interbred. What proportion of the offspring were pink?

- A 25%
- B 33%
- C 50%
- D 100%

3. A man has haemophilia. Which statement correctly describes the inheritance of the gene causing his condition?

- A He inherited the recessive allele from his mother.
- B He inherited the dominant allele from his father.
- C He can pass the recessive allele to a son.
- D He can pass the dominant allele to a daughter.

4 The diploid ( $2n$ ) chromosome number of *Drosophila* is 8. Copy and complete the table to show the different outcome of mitotic and meiotic division of a *Drosophila* cell.

	Mitosis	Meiosis
number of division cycles		
number of daughter cells		
number of chromosomes per nucleus in daughter cells		

5 Copy and complete the table to compare meiosis with mitosis.

Mitosis	Meiosis
maintains the chromosome number	
does not involve crossing over or independent assortment	
gives daughter nuclei that are genetically identical (apart from mutation) to one another and to the parent nucleus	

6 a Describe the essential difference between meiosis I and meiosis II.  
b State the similarity between meiosis II and mitosis.

7 There is no crossing over during meiosis in male *Drosophila*. Assuming that no mutation occurs, the only source of genetic variation is independent assortment. Given that the diploid ( $2n$ ) chromosome number is 8, calculate the number of genetically different spermatozoa that can be produced.

8 Distinguish between the following pairs of terms.

a **genotype** and **phenotype**

b **homozygous** and **heterozygous**

9 In sweet-pea plants, the gene **A/a** controls flower colour. The dominant allele gives purple flowers and the recessive allele red flowers.

A second gene, **B/b**, controls the shape of the pollen grains. The dominant allele gives elongated grains and the recessive allele spherical grains.

A plant with the genotype **AaBb** was test-crossed by interbreeding it with a plant with red flowers and spherical pollen grains.

Copy and complete the table to show that the expected ratio of phenotypes of the offspring of this cross. The gametes from one parent are already in the table.

Gametes	
AB	genotype: phenotype:
Ab	genotype: phenotype:
aB	genotype: phenotype:
ab	genotype: phenotype:

[5]

**10 a** The fruit fly, *Drosophila melanogaster*, feeds on sugars found in damaged fruits. A fly with normal features is called a wild type. It has a striped body and its wings are longer than its abdomen. There are mutant variations such as an ebony-coloured body or vestigial wings. These three types of fly are shown in the figure.

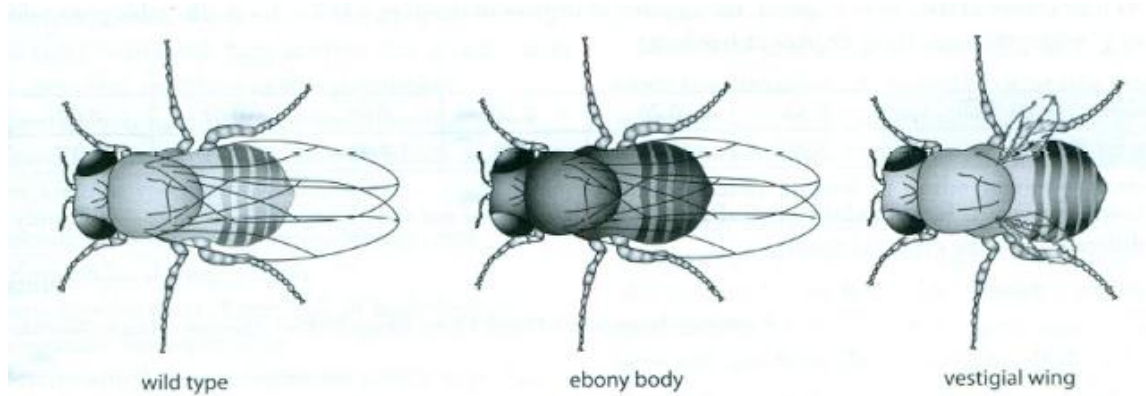

Wild-type features are coded for by dominant alleles: **A** for wild-type body and **B** for wild-type wings. Explain what is meant by the terms **allele** and **dominant**. [2]

**b** Two wild-type fruit flies were crossed. Each had alleles A and B and carried alleles for ebony body and vestigial wings.

Draw a genetic diagram to show the possible offspring of this cross. [6]

$$\chi^2 = \sum \frac{(O - E)^2}{E}$$

where:

$\Sigma$  = sum of

O = observed value

E = expected value

**c** When the two heterozygote flies in **b** were crossed, 384 eggs hatched and developed into adult flies. A chi-squared ( $\chi^2$ ) test was carried out to test the significance of the differences between observed and expected results:

**i** Copy and complete the table.

	Phenotypes of <i>Drosophila melanogaster</i>			
	grey body long wing	grey body vestigial wing	ebony body long wing	ebony body vestigial wing
Observed number (O)	207	79	68	30
Expected ratio	9	3	3	1
Expected number (E)	216	72	72	24
O - E	-9	.....	-4	6
(O - E) <sup>2</sup>	81	.....	16	36
(O - E) <sup>2</sup> /E	0.38	.....	0.22	1.50

**ii** Calculate the value for  $\chi^2$

[1]

The table below relates  $X^2$  values to probability values.

As four classes of data were counted, the number of degrees of freedom was  $4 - 1 = 3$ . The table gives values of  $X^2$  where there are three degrees of freedom.

Probability greater than	0.50	0.20	0.10	0.05	0.01	0.001
Values for $\chi^2$	2.37	4.64	6.25	7.82	11.34	16.27

iii Using your value for  $X^2$  and the table above, explain whether or not the observed results were significantly different from the expected results. [2]

[Total: 14]

[Cambridge International AS and A Level Biology 9700/41, Question 7, October/November 2009]

## 2. End-of-chapter answers

1 B 2 C 3 A

4

	Mitosis	Meiosis
number of division cycles	1	2
number of daughter cells	2	4
number of chromosomes per nucleus in daughter cells	8	4

5

Mitosis	Meiosis
maintains the chromosome number	halves the chromosome number
does not involve crossing over or independent assortment	involves both crossing over and independent assortment
gives daughter nuclei that are genetically identical (apart from mutation) to one another and to the parent nucleus	gives daughter cells that are genetically different from each other and from the parent nucleus

6 a **meiosis I**: separates homologous chromosomes;

**meiosis II**: separates sister chromatids;

b both separate sister chromatids;

7 ( $2^n$ , where  $n = 4$ )  $2 \times 2 \times 2 \times 2 = 16$

8 a **genotype**: the genetic constitution of an organism with respect to a gene or genes;

**phenotype**: the physical, detectable expression of the particular alleles of a gene or genes present in an individual;

b **homozygous**: describes a diploid organism that has the same allele of a gene at the gene's locus on both copies of the homologous chromosome;

9

Gametes	ab
AB	<i>genotype:</i> AaBb <i>phenotype</i> purple flowers and elongated pollen
Ab	<i>genotype:</i> Aabb <i>phenotype</i> purple flowers and spherical pollen
aB	<i>genotype:</i> aaBb <i>phenotype</i> red flowers and elongated pollen
ab	<i>genotype:</i> aabb <i>phenotype</i> red flowers and spherical pollen

[5]

homologous chromosomes;

10 a **allele:** variant form of a gene;**dominant:** allele that always expresses itself in the phenotype when present; [2]b **parental phenotypes:** wild type × wild type;**parental genotypes:** AaBb × AaBb;**gametes:** AB, Ab, aB, ab × same;**offspring genotypes;****offspring phenotypes;****heterozygous:** describes a diploid organism that has different alleles of a gene at the gene's locus on the

Gametes	AB	Ab	aB	ab
AB	AABB wild type	AABb wild type	AaBB wild type	AaBb wild type
Ab	AABb wild type	AAbb grey body vestigial wings	AaBb wild type	Aabb grey body vestigial wings
aB	AABB wild type	AaBb wild type	aaBB ebony body long wings	aaBb ebony body long wings
ab	AaBb wild type	Aabb grey body vestigial wings	aaBb ebony body long wings	aabb ebony body vestigial wings

[6]

c i

	Phenotypes of <i>Drosophila melanogaster</i>			
	grey body long wing	grey body vestigial wing	ebony body long wing	ebony body vestigial wing
<b>Observed number (O)</b>	207	79	68	30
<b>Expected ratio</b>	9	3	3	1
<b>Expected number (E)</b>	216	72	72	24
<b>O – E</b>	–9	7;	–4	6
<b>(O – E)<sup>2</sup></b>	81	49;	16	36
<b><math>\frac{(O - E)^2}{E}</math></b>	0.38	0.68;	0.22	1.50

ii 2.78; [1]

[3]

iii  $\chi^2$  value represents probability of > 0.05; difference in observed and expected results is not significant and is due to chance; [2]

[Total: 14]

## CHAPTER 18 – SELECTION AND EVOLUTION

### #117 Genetic variation

The variation that exists within a species is categorised as **continuous** and **discontinuous**.

The **environment** has considerable influence on the expression of features that show continuous (or quantitative) variation.



#### Discontinuous variation

- qualitative differences
- genetic basis:

- different alleles at a single gene locus have **large effects** on the phenotype
- different genes have quite different effects on the phenotype

- e.g.: eye colour

#### Continuous variation

- quantitative differences
- genetic basis:

- different alleles at a single gene locus have **small effects** on the phenotype
- different genes have the **same/additive** effect on the phenotype
- **polygenes** - large number of genes have a combined effect on a particular phenotypic trait

- e.g.: height; weight

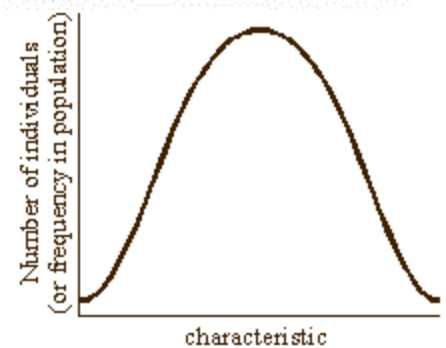
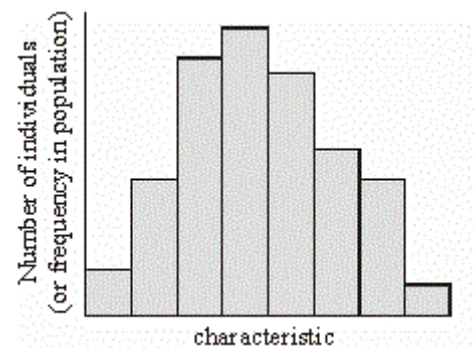

#### Environmental effects on phenotype

e.g.: hair colour of Himalayan rabbits, Siamese and Burmese cats  
 - development of dark extremities: tips to ears, nose, paws and tail  
 - caused by an allele that allows formation of dark pigments only at low temperature

e.g.: cob length of Black Mexican and Tom Thumb maize plants  
 - difference in light intensity and nutrients will lead to different growth of plants with the same genetic contribution  
 - use t-test to compare variation of the 2 different populations



**Importance of genetic variation in selection** - Genetic variation provides the raw material on which **natural selection** can act.

Variation within a population means that some individuals have **features** that give them an **advantage** over other members of that population.



## #118 Natural selection

Populations of organisms have the potential to produce large numbers of offspring, yet their numbers remain fairly constant year after year.

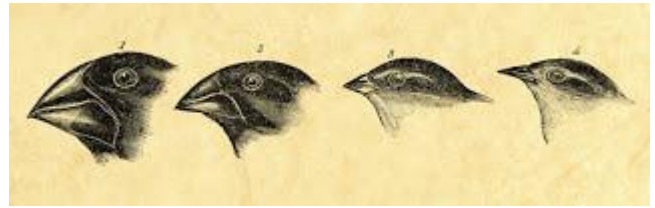

Natural selection occurs as populations have the capacity to produce many offsprings --> **compete** for resources --> individuals **best adapted** to survive breed and **pass on** their **alleles**.

**Variation** means some individuals in a population will have features which give them an **advantage** in the 'struggle for existence'.

### Environmental factors

- **biotic**: caused by other organisms  
e.g.: predation, food competition, infection by pathogens
- **abiotic**: caused by non-living components of the environment  
e.g.: water supply, nutrient level of soil

**Selection pressures** control the chances of some alleles being passed on to the next generation.

e.g.: predators - individuals that can better camouflage themselves survive more, pass on alleles

The effects of such selection pressures on the frequency of alleles in a population is called **natural selection**. The frequency of advantageous alleles increase, the frequency of disadvantageous alleles decrease.

### Types of selection

**Stabilising selection**: the status quo is maintained because the organisms are already well adapted to their environment

- acts **against extremes**
- favours the environment
- e.g.: birth weight

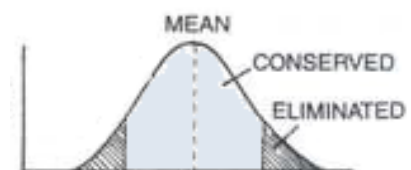

**Directional selection**: the most common varieties of an organism are selected against --> change in the features of the population

- favours variants of **1 extreme** when new allele appears or new environmental factor occurs
- e.g.: peppered moths



**Disruptive selection:** favours the survival of individuals at 2 different points within the range of variation, resulting in 2 different phenotypes

- conditions favour **both extremes** --> maintain different phenotypes in the population
- e.g.: Galapagos finches

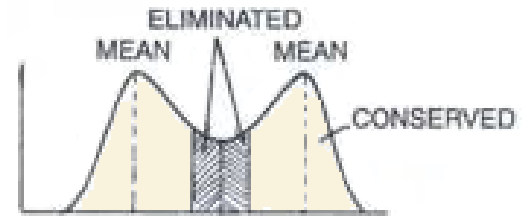

### Genetic drift

- a **change in allele frequency** of a small population
- occurs by chance, because only some of the organisms of each generation reproduce.

**The founder effect** occurs in small, isolated populations

- results from the **colonization** of a new location by a small number of individuals
- further genetic drift occurs in the small population
- evolution of this population may take a different direction from the larger population

### The Hardy-Weinberg principle

- when a particular phenotypic trait is controlled by 2 alleles of a single gene A/a
- genotypes: AA, Aa, aa
- calculate proportion of these genotypes in a large, randomly mating population

Equation 1:  $p + q = 1$

$p$  = frequency of dominant allele A

$q$  = frequency of recessive allele a

Total of whole population = 1

- chance of offspring inheriting dominant allele =  $p \times p = p^2$
- chance of offspring inheriting recessive allele =  $q \times q = q^2$
- chance of inheriting both dominant and recessive allele =  $2(p \times q) = 2pq$

Equation 2:  $p^2 + 2pq + q^2 = 1$

## #119 Artificial selection

Humans use **selective breeding** (artificial selection) to improve features in ornamental plants, crop plants, domesticated animals and livestock.

- selective pressure: humans
- individuals with **desirable features** are chosen to interbreed = **selective breeding**
- some of these desirable alleles are passed onto offspring
- offspring with the most desirable features are chosen to interbreed
- this is repeated **over many generations**

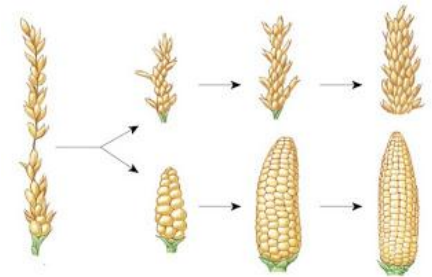

Over many generations, alleles deemed desirable by the breeder increase in frequency, while the 'disadvantageous' ones may completely disappear over time.

### Dairy cattle

- desirable features: docility, fast growth rates, high milk yield
- cows with desirable features are chosen to interbreed, and so are their offspring. This is repeated over many generations.

Bulls cannot be assessed for milk production as this is a sex-limited trait. Therefore, **progeny testing** is used: the performance of the bull's female offspring is looked at to see whether or not to use the bull in further crosses

- **background genes** (alleles of genes that help an organism adapt to its particular environment) are also considered during artificial selection



Belgian Blue cattle have been bred for increased meat production

### Crop improvement

- Introduction of **disease resistance** to varieties of wheat and rice to reduce loss of yield resulting from such infections
- Incorporate **mutant alleles for gibberellin synthesis** into dwarf varieties --> increase proportion of energy put into each grain --> increase yield
- Inbreeding and hybridisation:

- When maize plants are inbred, the plants in each generation become progressively smaller and weaker. This **inbreeding depression** occurs because, in maize, **homozygous** plants are less vigorous than heterozygous plants.
- Challenge when growing maize: heterozygosity and uniformity
- Solution: **Hybridisation** - cross between **2 homozygous** maize varieties --> find best hybrids

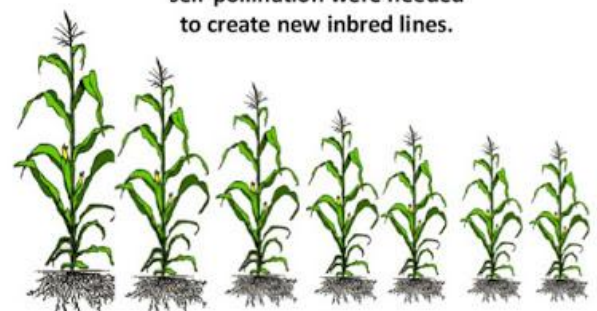

Historically 7+ generations of self-pollination were needed to create new inbred lines.

Inbreeding depression

## #120 Evolution and Extinction

General **theory of evolution**: organisms have changed over time.



### Molecular comparison between species

#### 1. Comparing amino acid sequences of proteins

Number of **difference** in the **nucleotide sequences** measure how closely related the species are.

HUMAN	KKASKPKKAASKAPT	KKPKATPVKKAKKK	LAATPKKAKKPK	TVKAKPVKASKPKKAKPVK
MOUSE	KKAAKPKKAASKAPS	KKPKATPVKKAKKK	PAATPKKAKKPK	VVKVPVKASKPKKAKTVK
RAT	KKAAKPKKAASKAPS	KKPKATPVKKAKKK	PAATPKKAKKPK	IVKVPVKASKPKKAKPVK
COW	KKAAKPKKAASKAPS	KKPKATPVKKAKKK	PAATPKKTKKPK	TVKAKPVKASKPKKTKPVK
CHIMP	KKASKPKKAASKAPT	KKPKATPVKKAKKK	LAATPKKAKKPK	TVKAKPVKASKPKKAKPVK

#### 2. Comparing nucleotide sequences of mitochondrial DNA

Human **mtDNA**:

- inherited through the **female line**
- zygote contains the mitochondria of the ovum
- mtDNA is circular so can't undergo any form of crossing over, changes in nucleotide sequence can only arise by **mutation**

Different human populations show differences in mitochondrial DNA sequences. This provides evidence for the origin of different populations --> '**molecular clock**' hypothesis:

- there is a **constant rate** of mutation over time
- the **greater** the number of differences in the sequence of nucleotides, the **longer ago** those individuals shared a common ancestor
- 'clock' can be estimated from fossil evidence

**A. Nuclear DNA is inherited from all ancestors.**

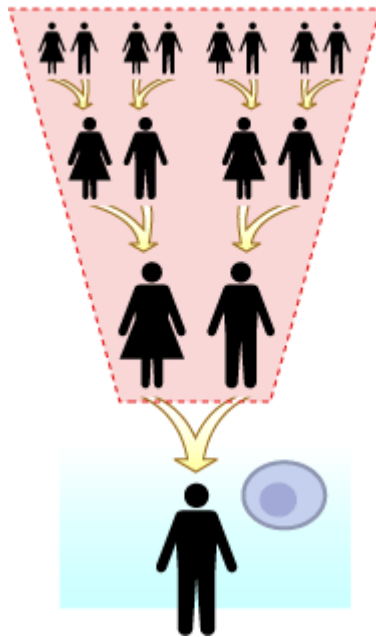

**B. Mitochondrial DNA is inherited from a single lineage.**

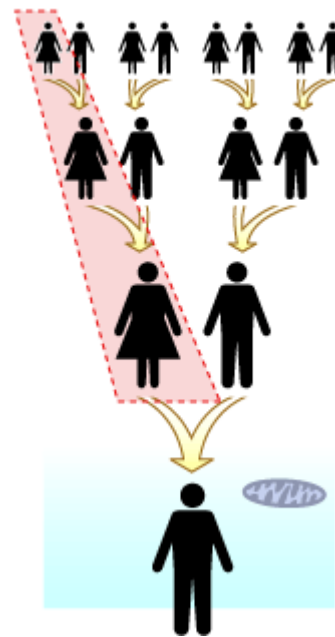

## Extinction

Species can become extinct through a variety of mechanisms.

- climate change
- increased **competition** from better adapted species
- human causes:
  - **loss of habitat**: draining wetlands, cutting down rainforests, pollution of air, water and soil
  - **killing**: for sports or for food
- **mass extinctions**:
  - sudden change in the environment: large asteroid colliding with the Earth

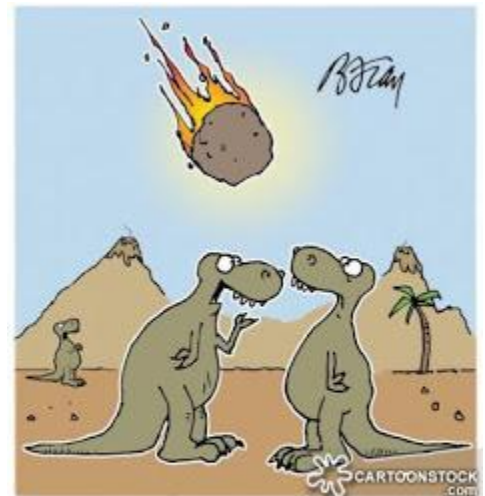

"SO, NO MATTER HOW BAD THINGS MAY LOOK, YOU JUST HAVE TO SAY TO YOURSELF, 'HEY, IT'S NOT THE END OF THE WORLD!'"

## #121 Species and speciation

Isolating mechanisms can lead to the accumulation of different genetic information in populations, potentially leading to new species.

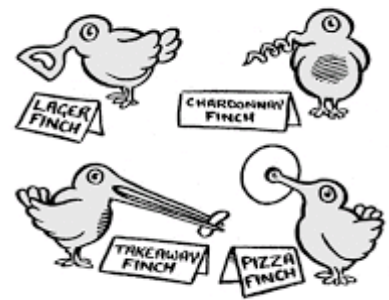

### Species and speciation

**species:** a group of organisms with

- similar morphological, physiological, biochemical and behavioural features
- can interbreed to produce **fertile offspring**
- **reproductively isolated** from other species

**speciation:** the production of new species

#### 1. Allopatric speciation

##### - geographical isolation

- population of species split and move to different areas
- each new population experiences **different selective pressures** --> features change over time, mutations occur
- when the different populations are reintroduced, they can no longer interbreed --> new species have **evolved**

#### 2. Sympatric speciation

- ecological and behavioural separation
- sympatric speciation usually occurs through **polyploidy**

- polyploidy organism: has more than 2 complete sets of chromosomes
- happens when meiosis goes wrong when forming gametes
- **tetraploidy**:  $2+2 = 4$ ; tetraploids are often sterile as 4 sets of chromosomes try to pair up during Meiosis I and get muddled up --> can reproduce **asexually**; usually happens in plants
- **triploidy**:  $1+2 = 3$ ; triploidy are always **sterile** as 3 sets of chromosomes can not be shared evenly between daughter cells
- the original diploid plant and tetraploid plant can no longer interbreed --> **new species** formed

## Kind of polyploidy

- **autopolyploid**: all sets of chromosomes from the same species

- **allopolyploid**: different sets of chromosomes from different but related species

Meiosis happens more easily in an **allopolyploid** than an autopolyploid (e.g.:

allotetraploid and autotetraploid) because the chromosomes from each species are not quite identical.

--> allotetraploid can be fertile

## Reproductive isolation

- the **inability** of 2 groups of organisms of the same species to **interbreed**

- due to geographical separation or behavioural differences

### 1. Prezygotic isolation

- individuals not recognizing each other as potential mates
- animals being physically unable to mate
- incompatibility of pollen and stigma
- inability of a male and female gamete fusion

### 2. Postzygotic isolation

- failure of cell division in the zygote
- non-viable offspring
- viable, but sterile offspring

\*postzygotic isolation is more wasteful of energy

## #122 Summary of Selection and Evolution

1 Genetic variation within a population is the raw material on which natural selection can act.

2 Meiosis, random mating and the random fusion of gametes produce genetic variation within populations of sexually reproducing organisms. Variation is also caused by the interaction of the environment with genetic factors, but such environmentally induced variation is not passed on to an organism's off spring. The only source of new alleles is mutation.



3 All species of organisms have the reproductive potential to increase the sizes of their populations, but, in the long term, this rarely happens. This is because environmental factors come into play to limit population growth. Such factors decrease the rate of reproduction or increase the rate of mortality so that many individuals die before reaching reproductive age.

4 Within a population, certain alleles may increase the chance that an individual will survive long enough to be able to reproduce successfully. These alleles are therefore more likely to be passed on to the next generation than others. This is known as natural selection.

5 Normally, natural selection keeps allele frequencies as they are; this is stabilising selection. However, if environmental factors that exert selection pressures change, or if new alleles appear in a population, then natural selection may cause a change in the frequencies of alleles; this is directional selection.

6 Over many generations, directional selection may produce large changes in allele frequencies. This is how evolution occurs.

7 The evolution of antibiotic resistance in bacteria and the spread of industrial melanism in moths are examples of changes in allele frequencies. The role of malaria in the global distribution of sickle cell anaemia is an example of how two strong opposing selection pressures can counterbalance each other in maintaining two alleles within certain populations.

8 A species can be defined as a group of organisms with similar morphology, behaviour, physiology and biochemistry that are capable of interbreeding to produce fertile off spring. In practice, however, it is not always possible to determine whether or not organisms can interbreed.

9 New species arise by a process called speciation. In allopatric speciation, two populations become isolated from one another, perhaps by some geographical feature, and then evolve along different lines until they become so different that they can no longer interbreed. In sympatric speciation, new species may arise through polyploidy.



10 Artificial selection involves the choice by humans of which organisms to allow to breed together, in order to bring about a desirable change in characteristics. Thus artificial selection, like natural selection, can affect allele frequencies in a population.

### 1. End-of-chapter questions

1 Which of the following gives rise to genetic variation in a population?

- 1 crossing over and independent assortment in meiosis
- 2 different environmental conditions
- 3 random mating and fertilisation
- 4 mutation

A 1,2,3 and 4      B 1, 2 and 3 only      C 1, 3 and 4 only      D 2, 3 and 4 only

2 A species of finch living on an isolated island shows variation in beak size. Birds with larger beaks can eat larger seeds.

After a period of drought on the island, large seeds were more plentiful than small seeds and the average size of the finches' beaks increased.

What explains this increase in size of beak?

- A artificial selection acting against finches with small beaks
- B directional selection acting against finches with small beaks
- C increased rate of mutation resulting in finches with larger beaks
- D stabilising selection acting against finches with the smallest and largest beaks

3 Which effect of natural selection is likely to lead to speciation?

- A Differences between populations are increased.
- B The range of genetic variation is reduced.
- C The range of phenotypic variation is reduced.
- D Favourable alleles are maintained in the population.

4 There are three genotypes of the gene for the  $\beta$ -globin polypeptide: HbAHbA, HbAHbs and HbsHbs.

Copy and complete the table to show which genotypes have a selective advantage or disadvantage in different regions of the world.

	Region with no malaria	Region with malaria
Genotype(s) with selective advantage		
Genotype(s) with selective disadvantage		

5 The wings of butterflies are covered with microscopic scales that give them their colour and also provide waterproofing.

The wings of

some species have large transparent areas through which the colour of the vegetation on which the butterfly has settled can be seen. Because they lack scales, these areas have poor waterproofing. The butterflies are eaten by birds.

a Describe two selection pressures that are likely to control the size of the transparent areas of the wings of these butterflies.

b In what circumstances might there be selection for larger transparent areas in the wings?

6 Rearrange the order of the following statements to give a flow diagram showing the evolution of resistance to the antibiotic streptomycin by the bacterium *Escherichia coli*.

1. Most of the population of *E. coli* is resistant to streptomycin.
2. A mutation in a DNA triplet of a plasmid, changing TTT to TTG, gives an *E. coli* bacterium resistance to streptomycin.
3. The resistant bacterium divides and passes copies of the R plasmid to its offspring.
4. Sensitive bacteria die in the presence of streptomycin as a selective agent.
5. The frequency of the mutated gene in the population increases.
6. The resistant bacterium has a selective advantage and survives.

7 Copy and complete the table to compare artificial selection with natural selection.

Natural selection	Artificial selection
the selective agent is the total environment of the organism	
adaptations to the prevailing conditions are selected	
many different traits contributing to fitness are selected	

8 Pale and dark peppered moths were collected and placed on pale and dark areas of bark on trees in a park in Liverpool, England. Some of the moths were predated by birds. The results of the investigation are shown in the table.

Colour of moth	Percentage of moths taken by birds	
	from pale bark	from dark bark
pale	20	44
dark	40	15

a 40 dark moths were placed on dark bark. Calculate the number of moths taken by birds. Show your working. [2]

- b** Suggest an explanation for the differences in the numbers of moths taken by birds. [4]

[Total: 6]

**9** The snail *Cepaea nemoralis* may have a yellow, pink or brown shell. Each colour shell may have up to five dark bands, or have no bands. Both shell colour and number of bands are genetically controlled. The snails are eaten by birds such as thrushes, which hunt by sight.

The following observations were made:

- Most snails living on a uniform background, such as short grass, have no bands.
- Most snails living on a green background, such as grass, are yellow.
- Most snails living on a non-uniform background, such as rough vegetation, have bands.

- a** Suggest an explanation for these observations. [4]  
**b** Predict the phenotype of snails living on a dark background of dead leaves. [2]  
**c** Suggest what will happen, during the course of a year, to the frequencies of the different alleles controlling shell colour and banding in a snail population living in deciduous woodland. (Deciduous trees shed their leaves in autumn. The background for the snails will be made up of dead leaves in the autumn and winter, and green vegetation in the spring and summer.) [4]

[Total: 10]

**10** The heliconid butterflies of South America have brightly coloured patterns on their wings. A hybrid between two species, *Heliconius cydno* and *H. melpomene*, has wing patterns that are different from both parental species.

An investigation was carried out to see whether the hybrid was a new species.

Separate groups of four butterflies, each consisting of a male and female of one of the parental species and a male and female of the hybrid, were placed together and their choices of mates recorded. The results are shown in the table.

	Number of matings	
	<i>H. melpomene</i> male	hybrid male
<i>H. melpomene</i> female	15	0
hybrid female	0	15
	<i>H. cydno</i> male	hybrid male
<i>H. cydno</i> female	5	3
hybrid female	0	5

- a** With reference to the information in the table, explain whether or not the results of the investigation suggest that the hybrid butterfly is a separate species. [4]
- b** Suggest how the hybrid could be reproductively isolated from the two parent species of butterfly. [2]
- c** Briefly describe how allopatric speciation can occur. [4]

[Total: 10]

## 2. End-of-chapter answers

1 C

2 B

3 A

4

	Region with no malaria	Region with malaria
Genotype(s) with selective advantage	Hb <sup>A</sup> Hb <sup>A</sup> Hb <sup>A</sup> Hb <sup>S</sup>	Hb <sup>A</sup> Hb <sup>S</sup>
Genotype(s) with selective disadvantage	Hb <sup>S</sup> Hb <sup>S</sup>	Hb <sup>A</sup> Hb <sup>A</sup> Hb <sup>S</sup> Hb <sup>S</sup>

**5 a** predation by birds, tending to increase the size of the transparent areas of the wings as they increase camoufl age;  
rainfall, because smaller transparent areas give an advantage;

**b** increased predation/drier conditions;

6 2, 4, 6, 3, 5, 1

1 mark for every 2 correct answers

7

Natural selection	Artificial selection
the selective agent is the total environment of the organism	the selective agent is humans
adaptations to the prevailing conditions are selected	phenotypes wanted by humans are selected
many different traits contributing to fitness are selected	selection may be for a single trait (which may not be advantageous for the organism)

**8 a**  $40 \times 40 \div 100 = 16$ ; [2]

**b** pale moths are camouflaged on pale bark, and dark moths on dark bark;  
predators/birds, hunt by sight;  
fewer moths taken that match bark;

refer to figures: 20% v. 44% of pale moths/15% v. 40% of dark moths; [4]

**[Total: 6]**

**9 a** camouflage from bird predators hunting by sight;  
yellow blends into grass but pink or brown are easily seen;  
bands break up outline against rough vegetation;  
yellow or pink without bands are easily seen; [4]

**b** brown/five bands; [2]

**c** selection favours alleles for brown shell and for bands in autumn and winter;  
selection favours alleles for yellow shell and few or no bands in spring and summer;  
gradual change in selection pressures as seasons change;  
keeps all alleles in the population; [4]

**[Total: 10]**

**10 a** behaves as good species with no intermating in relation to *H. melpomene*;  
15 matings between *H. melpomene* males and females and between hybrid males  
and females; behaves as less good species in relation to *H. cydno*;  
no matings between *H. cydno* males and hybrid females;  
but three matings between *H. cydno* females and hybrid males; [max. 4]

**b** select mates on basis of wing colours and patterns;  
hybrid wing pattern sufficiently different from parent species to give good isolation  
from *H. melpomene*; [2]

**c** needs geographical separation;  
selection pressure different in the separated populations;  
different alleles selected for;  
in time the differences between the two populations are so great that they do not  
interbreed should they happen to meet; [4]

**[Total: 10]**

## CHAPTER 19 – BIODIVERSITY

### #123 Biodiversity

Biodiversity is much more than a list of all the species in a particular area.

**species:** a group of organisms with

- similar morphological, physiological, biochemical and behavioural features
- can interbreed to produce **fertile offspring**
- **reproductively isolated** from other species



**ecosystem:** a relatively self-contained, **interacting** community of organisms, and the environment in which they live in and with which they interact

**niche:** role of an organism in an ecosystem

**habitat:** where a species lives within an ecosystem

**Biodiversity:** degree of **variation** of life forms in an ecosystem:

- variation in ecosystems or habitats
- number of species and their relative abundance
- genetic variation within each species

#### Species diversity

- species **richness:** number of species in a community

- species **diversity:** species richness and a measure of the **evenness of abundance** of different species

Ecosystems with high species diversity tend to be more **stable** --> more able to resist changes

- some ecosystems are dominated
- the tropics are important centres for diversity

#### Genetic diversity

genetic **diversity:** diversity of **alleles** within the genes in the genome of a single species; calculated

- what proportion of genes have different alleles
- how many alleles there are per gene

There is genetic diversity:

- between populations
- within each population

WWF Reports Global Biodiversity Down 30% In Only 40 Years

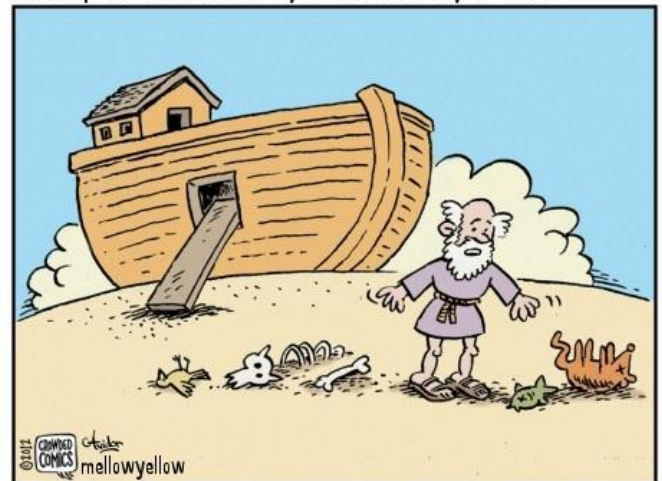

*I don't think we can blame this one on God.*

## #124 Assessing species diversity

There are 2 types of sampling: random sampling and systematic sampling.

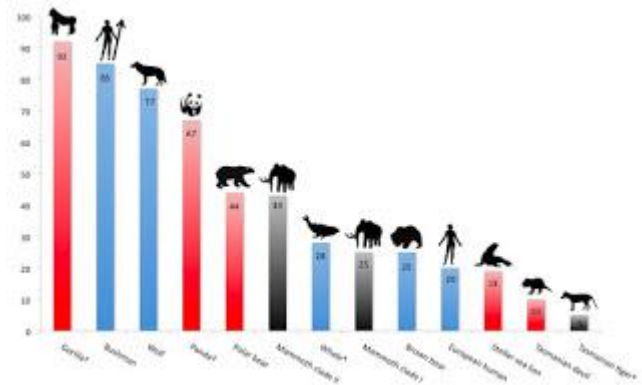

### Random sampling

- should be used when an area looks reasonably **uniform**
- there is no clear pattern to the way the species are distributed

--> avoids bias

#### a) Quadrats

- a square frame that marks off area of ground or water
- used to identify the different species present and/or to measure abundance
- use results to calculate:



- **species frequency**: measure of chance of a particular species being found within any one quadrat
- **species density**: measure of how many individuals there are per unit area

- use results to estimate:

- **percentage cover**: the percentage of area inside the quadrat that is occupied by each species
- abundance scale (e.g.: Braun-Blanquet scale) for number and plant cover

**b) Mark-release-recapture**: estimating the **population size** of mobile organisms

1. As many individuals caught as possible
2. Individuals get marked (in a way that will not affect its future chances of survival)
3. Marked individuals are counted (**a**)
4. Marked individuals are returned to their habitats to mix randomly with their population

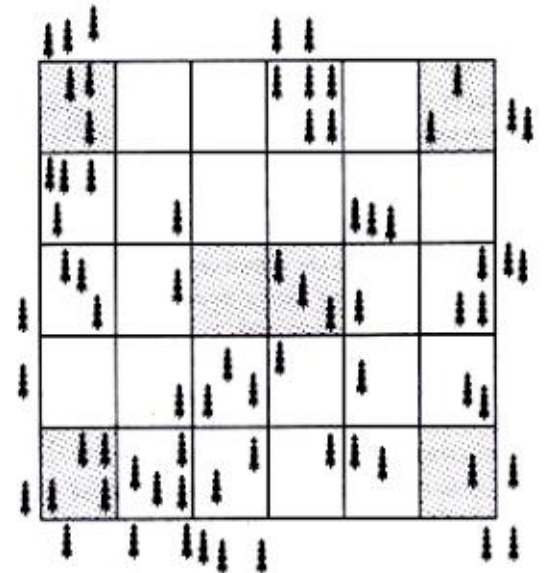
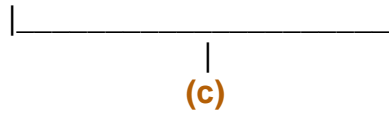

Fig: 6.4. Quadrat sampling method for population estimation.

5. After enough time has elapsed (at least 24 hours, maximum \_\_\_ hours), a large sample is recaptured

6. Number of marked (**b**) and unmarked individuals are counted



$$\text{Estimated number in the population} = \frac{a \times c}{b}$$

### Systematic sampling

- investigate species distribution where **physical conditions change**
- e.g.: altitude, soil moisture content, soil pH, exposure/ light intensity

#### a) Line transect

- record identity of organisms that touch the line at set distances
- data shown as a drawing



#### b) Belt transect

- place quadrats at regular intervals along line --> record abundance of species within quadrat
- data plotted as bar chart or kite diagram

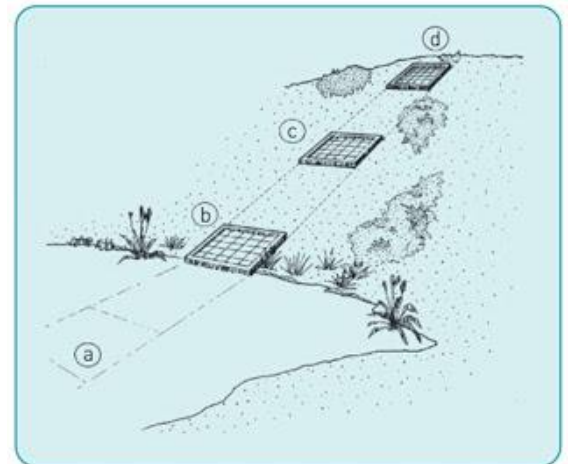

**Correlation** - plot a scatter graph or calculate **correlation coefficient** ( $r$ )

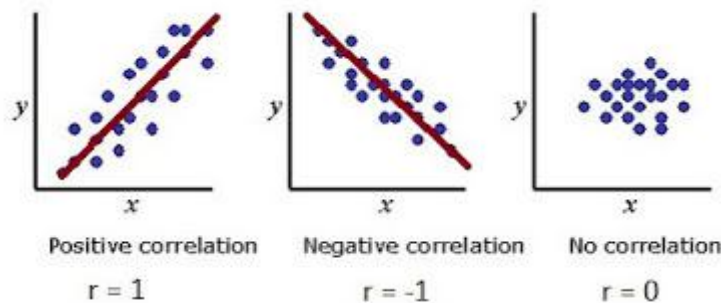



\*strength of correlation = how close the points are to the straight line

### 1. Pearson's correlation coefficient

$$r = \frac{\sum xy - n\bar{x}\bar{y}}{n s_x s_y}$$

use with 2 sets of data when data:

- continuous data has been collected
- must be normally distributed
- may be a linear correlation (draw scatter diagram first)
- quantitative data collected as measurements/counts
- number of paired observations is at least 5, ideally 10 or more

### 2. Spearman's rank correlation

use when data:

- data points are independent of each other
- data is correlated, but not linear (draw scatter diagram first)
- number of paired observations: at least 5, ideally between 10 and 30

$$r_s = 1 - \left( \frac{6 \times \sum D^2}{n^3 - n} \right)$$

$n$  number of pairs of items in the sample

$D$  difference between each pair of ranked measurements

- rank data for each variable and assess the difference between the rankings

- make a **null hypothesis**

### Simpson's Index of Diversity

When you have collected information about the abundance of the species in the area you are studying, use the results to calculate a value for **species diversity** in that area

$$D = 1 - \left( \sum \left( \frac{n}{N} \right)^2 \right)$$

- $n$  = total number of organisms in one species
- $N$  = total number of organisms of all species
- $D$  = Index of Diversity

## #125 Classification

Classification is arranging different kinds of organisms into groups.

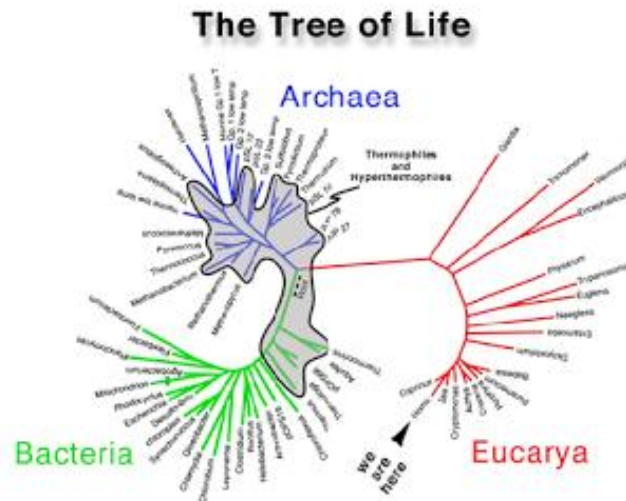

### Taxonomy

Taxonomy is the study and practice of **classification**, which involves **placing organisms** in a series of taxonomic units, or taxa.

#### How animals are classified

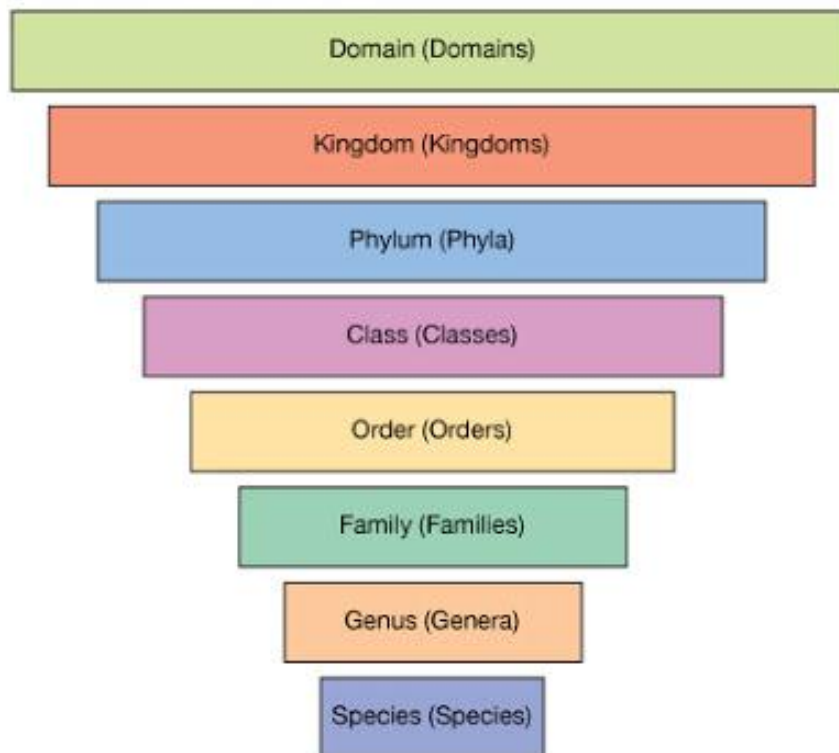

	<b>Bacteria</b>	<b>Archaea</b>	<b>Eukarya</b>
	prokaryotic		eukaryotic
<b>nucleus</b>	<b>absent</b>		<b>present</b>
<b>membrane-bound organelles</b>	<b>absent</b>		<b>present</b>
<b>DNA</b>	- circular "chromosome" - no histone proteins associated - smaller circular DNA molecules: plasmid		- inside the nucleus - arranged as linear chromosomes - has histone proteins - mitochondria and chloroplasts have circular DNA
<b>ribosomes</b>	70S < eukaryotes	70S < eukaryotes similar features	80S in cytosol > prokaryotes
<b>cell wall</b>	<b>present</b> , peptidoglycan	<b>present</b> , no peptidoglycan	some do, some don't
<b>cell division</b>	binary fission		mitosis
<b>reproduction</b>			sexually/asexually
<b>unique</b>		extremophiles – inhabit extreme environments	great diversity of forms - unicellular - colonial - multicellular organisms

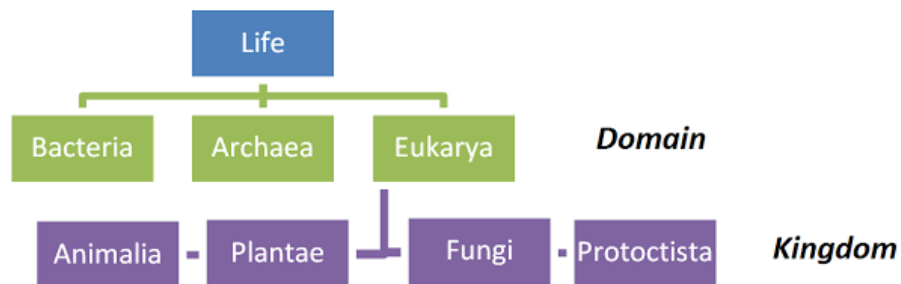

### 1. Kingdom Protocista (eukaryotic)

- mostly single-celled or groups of similar cells
- some are **protozoa**: have animal-like cells (no cell walls)
- some are **algae**: have plant-like cells (cellulose cell wall and chloroplasts)

## 2. Kingdom Fungi (eukaryotic)



- no chlorophyll --> does not photosynthesise
- **heterotrophic** nutrition: use organic compounds (carbon) made by other organisms as its source of energy and molecules for metabolism from - dead and decaying - feeding as parasites on living organisms
- reproduce by **spores**
- simple body form: unicellular or made of long threads called hyphae (with or w/o cross walls)
- cell walls of **chitin** (not cellulose)
- no cilia or flagella

Kingdom	Plantae	Animalia
	- multicellular eukaryotes - cells differentiated to form tissues and organs	
<b>specialised cells</b>	few types	many types
<b>chloroplasts</b>	✓ photosynthetic organism	*
<b>vacuole</b>	- large, permanent - for support	- small, temporary
<b>nutrition</b>	<b>autotrophic</b>	<b>heterotrophic</b>
	cells sometimes contain flagella	cells sometimes contain cilia and flagella
<b>unique</b>	- complex bodies - highly branched above and below ground	- communication by nervous system

## Virus

- microorganisms, only visible under an electron microscope
- **acellular** (cellular structure unlike bacteria and fungi)
- show none of the features traditionally used for classification

Some features:

- have particles made of protein and nucleic acid
- in free environment, viruses are **infectious**, but have **no metabolism**
- when viruses infect cells --> use biochemical machinery of host cell to copy their nucleic acid and make proteins to **destroy the host cell**
- energy provided by **respiration in host cell**

Taxonomy system - classified by:

- which **disease** the virus causes
- type of **nucleic acid** (RNA or DNA)
- whether nucleic acid is single or double stranded

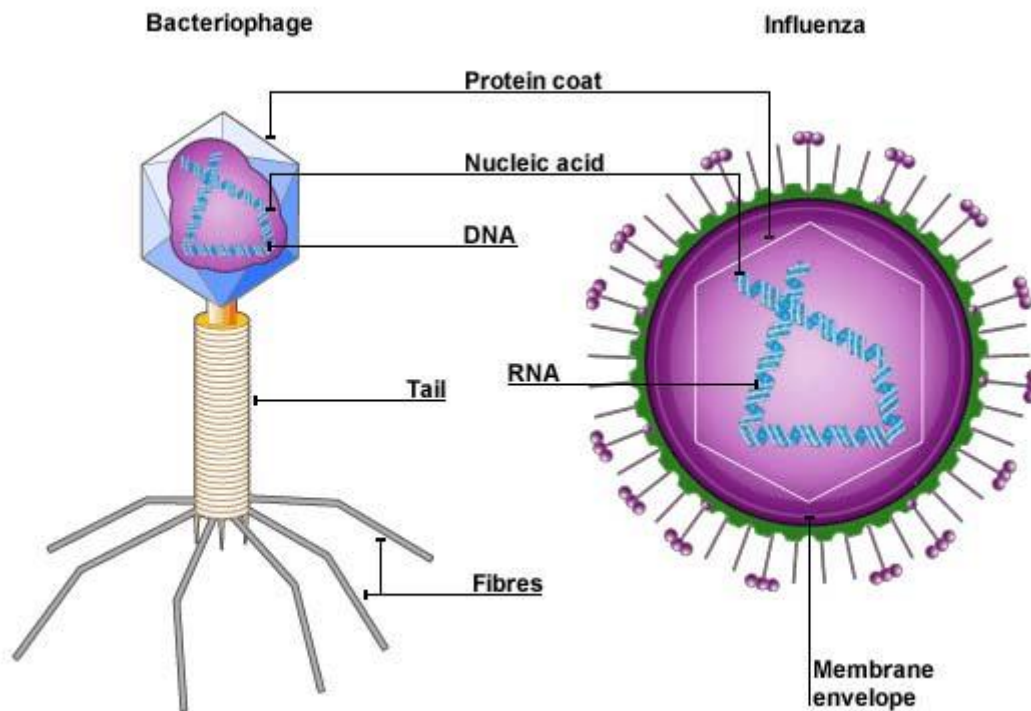

## #126 Threats to biodiversity

Biodiversity is under threat in many **aquatic** and **terrestrial** ecosystems as human population continues to increase and we take more resources from the environment and produce more waste.



### Threats to biodiversity:

- habitat loss and degradation of the environment
- climate change
- excessive use of fertilisers --> pollution
- overexploitation and unsustainable use of resources
- alien species invasion on native species

#### 1. Habitat loss

- **destruction of natural environment**: land clearing for agriculture, housing, transport,...

- e.g.: deforestation --> soil erosion --> severe land degradation

=> **habitat fragmentation** (habitats become divided)

- most at risk of extinction: endemic species on small islands

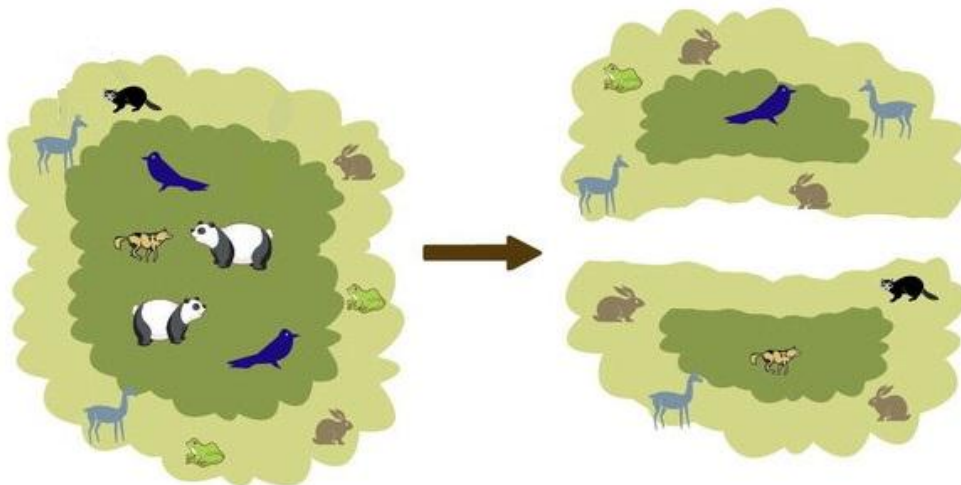

#### 2. Climate change

**Air pollution**: combustion of fuel with high sulfur content leads to high concentrations of atmospheric  $\text{SO}_2$

SO<sub>2</sub> in atmosphere + H<sub>2</sub>O = **acid rain**

- destroys vegetation
- acidification of aquatic ecosystems: animals can't breed/survive in waters of low pH

Industrialisation, extraction and combustion of fossil fuels

increases concentration of CO<sub>2</sub> and CH<sub>4</sub> in the atmosphere = **greenhouse gas** --> climate change

---> **global warming**

- change in **distribution** of terrestrial ecosystems: organisms will migrate north or south to cooler and higher latitudes. There will also be competition between migrating organisms
- **acidification** of the oceans: destroy CaCO<sub>3</sub> mollusc shells
- rise in sea levels
- increase in the **frequency** of natural catastrophies (hurricane, flooding,...)

e.g.: flooding: increases the concentration of nutrients in coastal waters --

> increases growth of phytoplanktons which provides food for starfish larvae --> adult starfish eats the coral

- coral bleaching: corals provide protection for many coastlines. Corals are very sensitive to temperature increases --> die

# CORAL BLEACHING

Have you ever wondered how a coral becomes bleached?

### HEALTHY CORAL

1 Coral and algae depend on each other to survive.

Corals have a symbiotic relationship with microscopic algae called zooxanthellae that live in their tissues. These algae are the coral's primary food source and give them their color.

### STRESSED CORAL

2 If stressed, algae leaves the coral.

When the symbiotic relationship becomes stressed due to increased ocean temperature or pollution, the algae leave the coral's tissue.

### BLEACHED CORAL

3 Coral is left bleached and vulnerable.

Without the algae, the coral loses its major source of food, turns white or very pale, and is more susceptible to disease.

### WHAT CAUSES CORAL BLEACHING?

- Change in ocean temperature**  
Increased ocean temperature caused by climate change is the leading cause of coral bleaching.
- Runoff and pollution**  
Storm generated precipitation can rapidly dilute ocean water and runoff can carry pollutants — these can bleach near-shore coral.
- Overexposure to sunlight**  
When temperatures are high, high solar irradiance contributes to bleaching in shallow water corals.
- Extreme low tides**  
Exposure to the air during extreme low tides can cause bleaching in shallow corals.

NOAA's Coral Reef Conservation Program  
<http://coral.reef.noaa.gov/>

### 3. Fertilisers and pollution

\*pollutant: substances that animal bodies are unable to metabolise or excrete

- **factory wastes** flow into rivers without any treatment --> substance persists --> enters food chains --> weakening of immune systems and reduction in fertility in birds and mammals
- marine pollutant: **non-biodegradable plastic**

e.g.: - animals (dolphins) get caught in discarded fishing nets and die  
- turtles eat plastic bags, mistaken then for jellyfish --> chokes



- **excess fertilisers** (not absorbed by crop plants) drain into river --> **extra nutrients** cause growth of producers, such as algae:
  - produce toxic substances
  - algae growth unbalances food web



## #127 The need to maintain biodiversity

For some people, the **safety of biodiversity** is simply a moral or ethical issue. For others it may be for ecological reasons, aesthetic reasons, social and commercial reasons or for other services.



### Ecological reasons

- the higher the **diversity** of an ecosystem, the less likely it is to be unbalanced by changes in conditions or threats such as pollution
- ecosystems are of **direct value** to humans

e.g.: - antibiotics from fungi, bacteria  
 - anti-cancer drugs isolated from plants

### Aesthetic reasons

- people **gain pleasure** from studying or just appreciating the natural world (inspiration to artists, poets, photographers,...)
- **ecotourism**: wildlife = source of income --> provides employment; contributes to economies

### Social and commercial reasons

- wild plants species that are **resistant** to large numbers of disease of rice known as bacterial blight --> interbreed with cultivated rice (crop plants don't have much genetic diversity as their wild relatives, because it has been lost by selective breeding for uniform, high-yielding crops)
- **microorganisms** = source of useful products

e.g.: *Taq* polymerase used for PCR in forensic and DNA analysis

### Other services

- forests absorb **CO<sub>2</sub>** --> lowers the effect of high CO<sub>2</sub> concentration in the atmosphere
- **organic waste** added in water gets broken down by microorganisms
- **transpiration of plants**: contribute to the water cycle - provides water for drinking and irrigation
- termites, ants, fungi, bacteria recycle elements (C,H,O,N,...)

## #128 Protecting endangered species

An endangered species is one that is threatened with extinction. The best way to conserve any species is to keep it in its **natural habitat**.



**National parks** - conservation areas with strict limits to protect wildlife and the environment

- **alien** animal species are **removed**; invasive plants are dug up and destroyed
- restriction on human activities; **tourism** raises money and awareness
- marine parks: conserve fragile ecosystems and areas at risk of overfishing, dredging, pollution

**Zoos** - protection for **endangered** and vulnerable species; provides enjoyment and interest for visitors

- **captive breeding programmes**: help reintroduce animals to their natural habitats
- problems:
  - **inbreeding**, when breeding animals from a small population
  - some captive bred animals don't know how to avoid predators, find food, rear young
  - animals refuse to breed in captivity; hard to recreate suitable habitat --> animal can't be returned to the wild
- for **research**: understand breeding habits, habitats, how to increase genetic diversity, solution in inbreeding problems

### Botanic gardens

- seeds/cuttings are collected from species in the wild and are used to build up a population of plants that can one day be reintroduced into the wild
- sample of cells grown on agar (in sterile conditions)
  - > cells divide by mitosis to give a mass of cells which can be cloned
  - > cells transferred to a medium contain an appropriate mixture of plant hormones
  - > grow stems, roots
  - > transferred to soil

Roles of botanic gardens:

- **protect** endangered plant species
- **research** methods of reproduction and growth
- research conservation methods
- **reintroduce** species to habitats
- **educate** the public (roles of plants in the ecosystem; economic value)



### Frozen zoo

Holds **genetic resources** for endangered species in the form of eggs, sperms and embryos

- more genetic **diversity**
- **genetic material** is kept for longer periods of time

\*eggs are more difficult to freeze as they are more likely damaged by freezing and thawing

### Seed banks

Seeds of the **same species** are collected from **different sites**, so that the stored samples contain a good proportion of the **total gene pool** of that species --> genetic diversity is not lost

"Recalcitrant" seeds cannot be dried and frozen. These include seeds of economically important tropical species e.g.: rubber, coffee, cocoa. The only ways to keep the genetic diversity of these species are to

- collect seeds and grow successive generations of plants
- keep as tissue culture

\* seeds can be stored for a long time with **little maintenance**, anywhere in the world

\* seeds are germinated every few years to:

- check if seeds are still viable
- produce new plants to collect new seeds
- find conditions for breaking seed dormancy



## #129 Assisted reproduction and problems of successful conservation

Assisted reproduction is a solution to the problem of **inbreeding**.

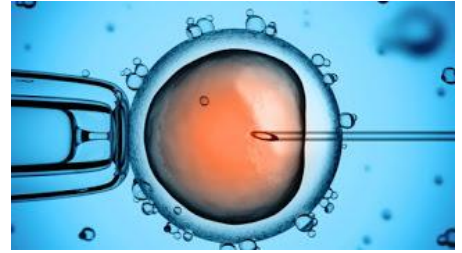

### Assisted reproduction

**Sperm bank** - freezing collected semen

Sperm samples are **collected** from males, checked for sperm activity and then **diluted** with a medium containing a **buffer solution** and albumen. Small volumes of semen are put into **straws** (thin tubes) and are stored in **liquid nitrogen** at -196 degrees Celcius.



### Artificial insemination (IA)

- a straw is placed into warm water to activate sperm
- the **straw** is placed into a **catheter** --> inserted into the vagina, through the cervix, into the uterus
- resulting embryos are 'flushed out' of the uterus
- **embryo transfer**: embryo gets transferred to other females (**surrogate mothers**) that had had hormonal treatment to prepare for pregnancy

- protects endangered animals from pregnancy
- the endangered female becomes the source of many offspring

### In-vitro fertilisation (IVF)

- oocyte collected by inserting needle into ovaries --> withdraw **mature follicles**
- oocyte cultured in a medium --> mixed with semen
- resulting zygotes divide --> form embryos --> cultured for several days
- **embryo is placed** into the mother or into several females of same or different species

### Problems of successful conservation

- organism is saved from extinction has increased in numbers beyond the capacity of the ecosystem to sustain such numbers.
- **culling**: aim - to reduce numbers

- transferring animals to places with small populations
- birth control: **chemical contraceptives**: vaccine that targets the region surrounding layer of glycoprotein around egg (vaccine produces immune response --> produce antibodies against glycoproteins)

- antibodies attach to glycoprotein and block sperms from fertilising egg
- 90% success rate



## #130 Controlling alien species

Alien or **invasive species** are those that have moved from one ecosystem to another where they were previously unknown.

### Causes:

- humans **trading** animals and plants
- introduced as biological **control agents** to control pests
- **escapees**
- animals introduced for **sport**



### Effects:

- become successful **predators**
- compete effectively with native organisms of the **same niche**, pushing them to extinction
- introduce **diseases** --> spread to organisms that have been exposed to that pathogen



### Examples:

#### Water hyacinth:

- grow successfully --> covers huge areas of land and water
  - > blocks sunlight from reaching native aquatic plants
  - > reduce concentration of oxygen in the water
  - > kills fish
- habitat for mosquito larvae



**Japanese knotweed:**

- vigorous root systems --> forces its way through concrete and damaged buildings, roads, walls
- outcompetes native species by reducing space where they grow

**Cane toad:**

- introduced to Queensland, Australia from Hawaii in 1935
- aim: control insect pest of cane sugar
- the cane toad bred rapidly, spreading across the country
- has few predators in Australia as the toad produces a toxin that kills animals that eat it

**Red lionfish:**

- native to seas of South-East Asia
- escapee from the Caribbean
- becomes a predator in its new environment; eats local species of coral reefs

**Indian mongoose:**

- introduced to Jamaica in 1872
- aim: control rats in cane fields
- the mongoose did so well it became a predator to other animal

## #131 International conservation and restoring degraded habitats

Non-governmental organisations, such as the World Wide Fund for Nature (**WWF**) and the Convention on International Trade in Endangered Species of Wild Fauna and Flora (**CITES**), play important roles in local and global conservation.

An important part of conservation is **restoring degraded habitats** so that they may support a flourishing community with high biodiversity.



### NGOs in local and global conservation

**CITES** - Convention on International Trade in Endangered Species of Wild Fauna and Flora

- a signed agreement to **control trade** of endangered species and their products
  - e.g.: fur, skin, ivory,...
- considers **evidence** presented to it about endangered species
  - > assigns to 1 of 3 appendices with given criteria and trading regulations
- sometimes CITES listings don't benefit the species:
  - species trade becomes **illegal** --> price for products increase --> **more trade** occurs



**WWF** - World Wide Fund for Nature - the #1 campaigning group for wildlife

- "to **stop degradation** of the planet's natural environments
  - build future where humans and nature live **in harmony**."
- funds conservation projects
  - publicises environmental issues and campaigns





## Restoring degraded habitats

so they may support a flourishing community with **high biodiversity**

- degradation: human activity or natural catastrophe

- **restoration:**

- e.g.: small scale - farmer plants trees on land that is no longer needed for food production
- e.g.: replanting mangrove forests
  - provides protection against storm damage, flooding, rising sea levels
  - important nursery grounds for young fish
  - Planting trees in Haiti
  - after deforestation, soil erosion,....
  - Eden project, UK
  - reclamation project
  - educated people in plant biodiversity and the need for conservation



## #132 Summary Biodiversity and conservation

1 All living organisms may be classified into one of the five kingdoms: prokaryotes, protocists, fungi, plants and animals.

2 Biodiversity includes the range of habitats (environments) and species in an area, and the genetic diversity within a species.

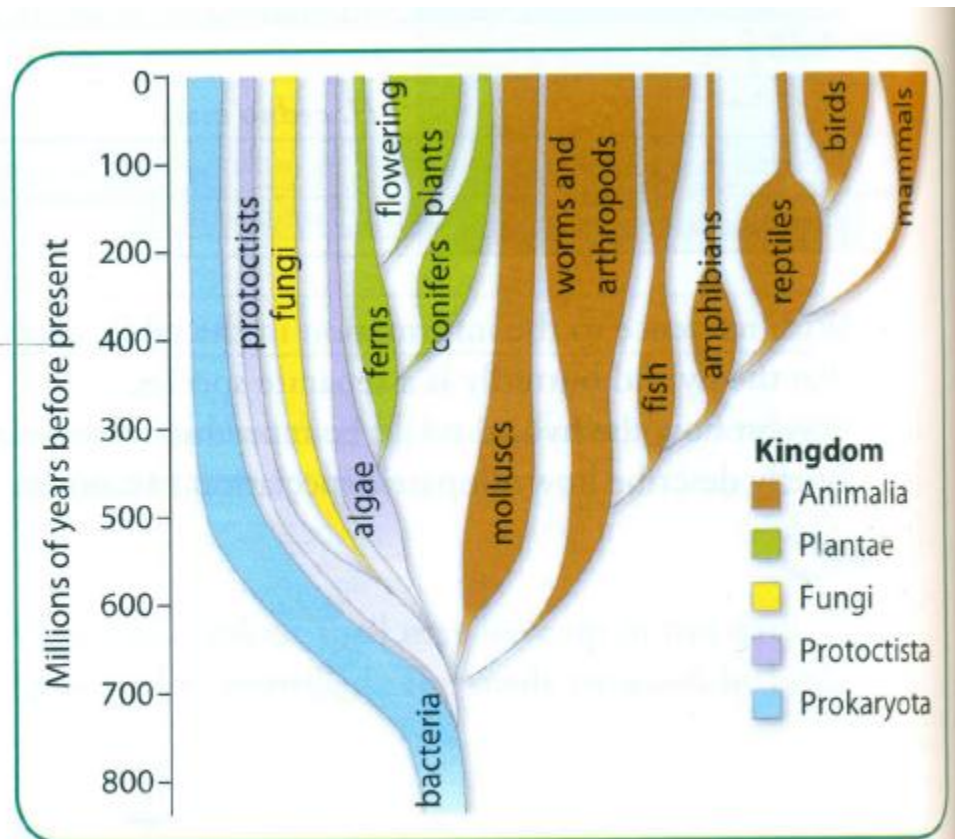

Possible evolutionary relationships of the five kingdoms.

3 There are moral and ethical reasons for maintaining biodiversity, and also more practical ones. For example, we may be able to use plants to provide medicines, and animals to provide alleles to use in animal breeding.

4 Species may become in danger of extinction through habitat loss, change to their environment (perhaps as a result of pollution) and overexploitation by humans.

5 Conservation of an endangered animal species may involve captive breeding programmes, in which viable populations are built up in zoos and wildlife parks. These programmes try to ensure that the gene pool is maintained and inbreeding is avoided. At the same time, attempts are made to provide a suitable habitat in the wild, so that captive-bred animals can eventually be re-released into the wild. Local people are involved, because this increases acceptance of the project and the chances of its success.

6 Botanic gardens and seed banks help to conserve threatened plant species by breeding them for reintroduction into an appropriate habitat. Seed banks provide suitable conditions to keep different types of seeds alive for as long as possible. Samples of the seeds are grown into adult plants every now and then, so that fresh seed can be collected.

7 Many countries have protected areas called national parks, which often cover large areas. These are set up to conserve rare and endangered species and to maintain their habitats. Often legislation is passed to ensure their protection. In such areas, agriculture is controlled and building, mining and other industries strictly regulated. Access is often limited but not forbidden, as one aim of most such parks is to educate people about the importance of conservation. 8 Other, smaller, conservation areas may be created to protect particular species and habitats.

### 1. End-of-chapter questions

Which organism is a fungus?

Key: ✓ = present ✗ = absent

Organism	Ribosomes		Cell walls			
	70S	80S	none	cellulose	chitin	peptidoglycan
A	✓	✗	✗	✗	✗	✓
B	✗	✓	✓	✗	✗	✗
C	✗	✓	✗	✓	✗	✗
D	✗	✓	✗	✗	✓	✗

2 Which of the statements about Protoctista are correct?

- 1 a eukaryote that is not a fungus, plant or animal is a protoctist
- 2 an organism with cellulose cell walls and chloroplasts may be a protoctist
- 3 an organism existing as a group of similar cells may be a protoctist
- 4 a single-celled heterotrophic eukaryote is a protoctist

**A** 1,2,3 and 4      **B** 1, 2 and 4 only      **C** 2 and 3 only      **D** 3 and 4 only

3 A gene bank is a store of the genetic variation of a species. Which of the following are gene banks?

- 1 captive animals in a zoo

- 2 plants in a botanic garden
- 3 seeds in a seed bank
- 4 plant cells growing in tissue culture
- 5 frozen sperm, eggs or embryos

**A** 1, 2, 3, 4 and 5    **B** 1, 2 and 3 only    **C** 2, 3 and 4 only    **D** 3, 4 and 5 only

**4** Copy and complete the table to show the features present in the five different classificatory Kingdoms of living organisms. Use a tick (✓) to show the presence of a feature and a cross (x) to show its absence.

Feature	Kingdom				
	Prokaryota	Protocista	Fungi	Plantae	Animalia
autotrophic					
heterotrophic					
cells have nuclei in nuclear envelopes					
cells have internal membranes					
cells are differentiated to form tissues					

Add caption

- 5** Distinguish between orthodox and recalcitrant seeds.
- 6 a** Explain what is meant by biodiversity. [2]
- b** Over half of the living species of plants and animals live in tropical rainforests. Suggest why this is so. [4]
- c** Some rainforest species, for example the squirrel monkey in Costa Rica, are endangered. Suggest four ways to conserve an animal species such as the squirrel monkey. [4]
- d** List four practical reasons why humans should try to maintain biodiversity. [4]

**[Total: 14]**

**7 a** In many cases, the reason for an organism becoming endangered is the loss of its habitat as a result of human activity. List four ways in which human activity causes habitat loss. [4]

**b** In 1973, the population of African elephants in Kenya was about 167000 animals, but by 1989 the population had dropped to about 16000 animals. In 2010 the population had risen to about 36000 animals. Suggest explanations for these changes. [6]

**c** Explain:

**i** how captive breeding of animals, such as the scimitar-horned oryx, can help conserve an endangered species; [3]

ii how genetic diversity can be maintained during a captive breeding programme. [3]

[Total: 16]

8 The American crocodile, *Crocodylus acutus*, was classified as an endangered species by the USA in 1975. It is found in estuarine regions of southern Florida.

The salinity of the water was thought to play a part in the distribution of the American crocodile. The figure shows the number of American crocodile nest sites in areas with water of varying salinity in southern Florida.

a Describe the results shown in the figure. [3]

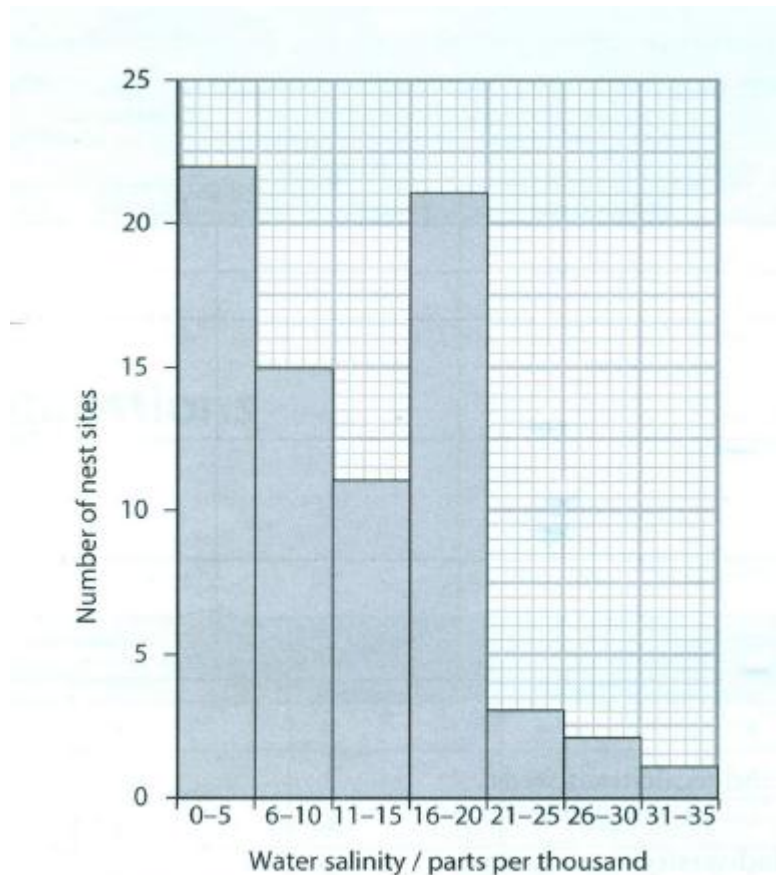

b Much conservation work has been done in the Everglades National Park in Florida, which is a large wetland area. As a result, the number of nest sites increased from eight in 1975 to 31 in 2000. This led to a rise in the number of crocodiles.

i Calculate the percentage increase in nest sites between 1975 and 2000. Show your working. [2]

ii Suggest two reasons why the population of crocodiles in the Everglades National Park has increased.[2]

[Total: 7]

[Cambridge International AS and A Level Biology 9700/42, Question 1, May/June 2010,]

## 2. End-of-chapter answers

1 D 2 A 3 A

4

Feature	Kingdom				
	Prokaryota	Protoctista	Fungi	Plantae	Animalia
autotrophic	✓	✓	✗	✓	✗
heterotrophic	✓	✓	✓	✗	✓
cells have nuclei in nuclear envelopes	✗	✓	✓	✓	✓
cells have internal membranes	✗	✓	✓	✓	✓
cells are differentiated to form tissues	✗	✗	✗	✓	✓

**5 orthodox seeds:** can be dehydrated and frozen for long-term storage;

**recalcitrant seeds:** cannot be dehydrated and frozen;

**6 a biodiversity:**

range/variety, of, species/communities/ecosystems;

the genetic variation within a species;

the genetic variation between species; [max. 2]

**b** high rate of photosynthesis/rapid growth of plants; allows large number of plant species;

available throughout the year;

provides niches for large number of animal species; [4]

**c** maintain as a captive population in a zoo/captive breeding;

set up conservation area/protect habitat from clearance;

ban, hunting/capture;

educate public/introduce ecotourism; [4]

**d** as resource for, food/materials;

as source of alleles for breeding to improve agricultural species;

as potential medicines; for ecotourism/leisure;

to maintain, food webs/nutrient cycles; [max. 4]

[Total: 14]

- 7 a** clearing land for agriculture;  
clearing land for housing;  
clearing land for industrial building;  
clearing land for, road building/railways/pipelines/  
other infrastructure;  
mining;  
logging;  
pollution/global warming; **[max. 4]**
- b** fall from 167 000 to 16 000 due to a combination of factors including:  
ivory hunting;  
game hunting;  
hunting for meat;
- killing after damage to village crops;  
habitat loss;  
rise after 1989 due to ban on ivory trading;  
rise only to 36 000 because other factors still apply: habitat loss;  
poaching;  
killing after damage to village crops; **[max. 6]**
- c i** bred in several places so not all at risk from same disease;  
increased numbers of animals;  
allows return of animals to wild; **[3]**
- ii** close relatives are not interbred; e.g. siblings/father with daughter;  
in-vitro fertilisation used to breed from distant animals;  
refer to embryo donation and use of surrogates; **[max. 3]**

**[Total: 16]**

- 8 a** more nests in less saline areas;  
22 nests at 0–5 parts per thousand compared with 1 at 31–35 parts per thousand;  
anomalous result for 16–20 parts per thousand; **[3]**

$$\begin{aligned} \mathbf{b\ i} \quad & \frac{31-8}{8} \times 100; \\ & = 288; \end{aligned}$$

**[2]**

- ii** more fresh water/lower salinity;  
sites protected;  
ecotourism encouraged;  
ban on hunting;  
less pollution; **[max. 2]**

**[Total: 7]**

## CHAPTER 20– GENETIC TECHNOLOGY

### #133 Genetic engineering basics

Genetic engineering involves the manipulation of naturally occurring processes and enzymes.

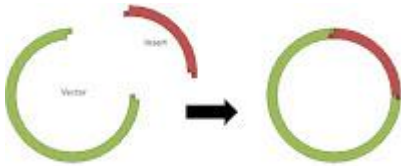

Recombinant DNA (**rDNA**): DNA made by joining pieces from two or more **different sources**

Genetic engineering:

- **extraction/syntheses** a gene(s) from one organism
- **transfer** gene(s) into another organism (of same or different species)
- --> gene is **expressed** in new host

#### Plasmids as vectors in gene cloning

Plasmids are small, circular pieces of double-stranded DNA

- **small** --> easy to use
- **exist naturally** in bacteria --> bacteria take up plasmids from surroundings
- can be produced **artificially**
- double stranded: can **insert genes** from prokaryotes and eukaryotes
- **replicate independently** in bacteria
- can be **transferred** between different bacterial species

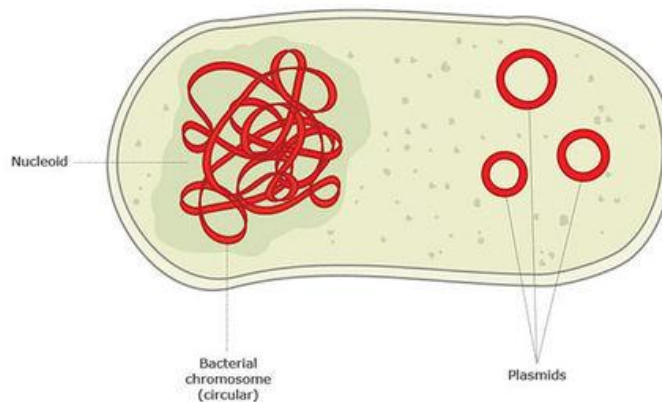



**Promoters** - control **expression** of genes --> ensure high levels of gene expression

Promoter binds to DNA strand

- allows RNA polymerase to bind to DNA
- ensures RNA polymerase recognizes which is the template strand

--> promoter region = transcription startpoint

### Enzymes:

**Restriction endonuclease:** restrict viral infections by recognising and breaking down DNA of invading viruses.

--> binds to **specific target site** on DNA (sequence of bases) --> **cut sugar-phosphate backbone:**

- straight across = blunt ends
- staggered fashion = sticky ends\*

\* **sticky ends:** short lengths of unpaired bases; easily form hydrogen bonds with complementary base sequences on other fragments of DNA cut with the **same restriction enzyme**

### Reverse transcriptase:

- uses single-stranded **mRNA** as the **template**
- reverses the transcription process: produces single stranded DNA
- single-stranded DNA + DNA polymerase = double-stranded complementary DNA (**cDNA**)

**DNA ligase:** links together **sugar-phosphate backbones** of DNA molecules and plasmid --> produces a closed circle of double-stranded DNA containing the new gene = "recombinant DNA"

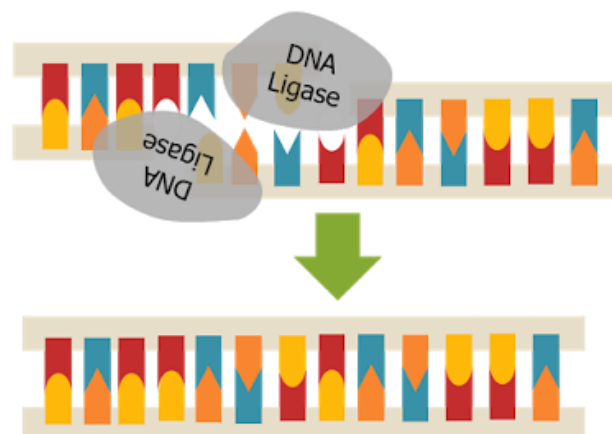

## #134 PCR and gel electrophoresis

The polymerase chain reaction (PCR) and gel electrophoresis both work with molecules. Both these procedures are needed for forensic science.



**Polymerase chain reaction (PCR)** - rapid production of a **large number of copies** of a particular DNA fragment

1. DNA is **denatured** at 95 degrees Celcius --> separate DNA strands to expose bases
2. attach **primers** to ends of single-stranded DNA at 65 degrees Celcius
3. **elongation**: DNA polymerase builds new strands of DNA against exposed ones at 72 degrees Celcius

- \* **Taq polymerase** - 1st heat-stable polymerase used in PCR
  - not destroyed in denaturation: no need to be replaced after each cycle
  - high optimum temperature to maximize efficiency
  - > temperature doesn't need to be dropped for annealing process

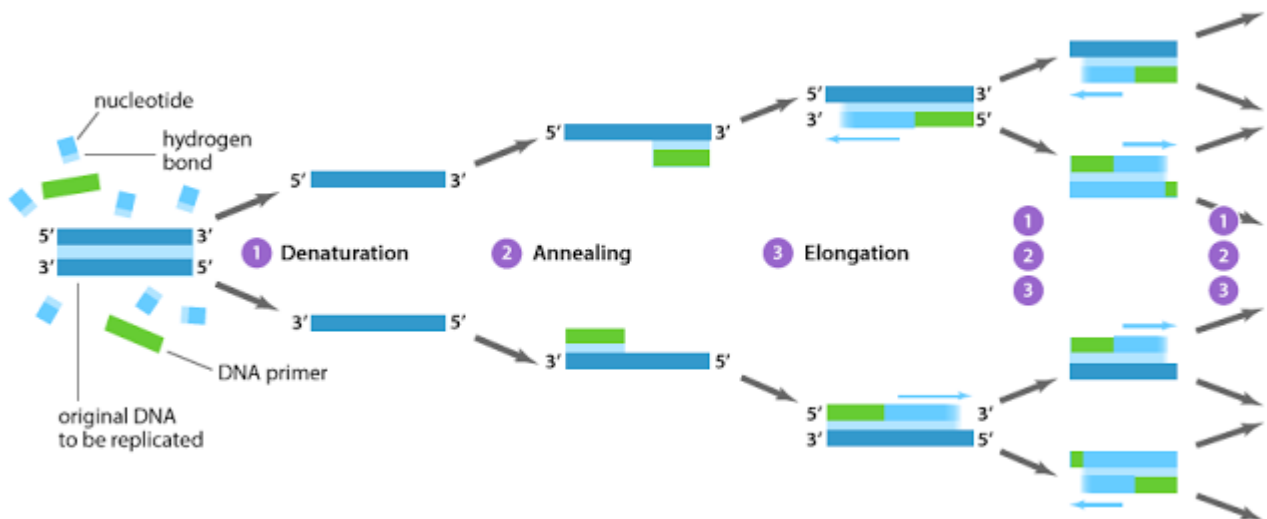

**Gel electrophoresis** - to **separate** different molecules; **analysis** of proteins and DNA)

- place mixture of molecules into wells cut in **agarose gel** --> apply electric field
- factors affecting movement speed of molecules:

- net charge of molecules

- size of molecule
- composition of gel: size of 'pores' within gel

### Electrophoresis of proteins

- separates **polypeptides** produced by different alleles of many genes

- charge on protein is dependent on the ionisation of the R groups on the amino acid residues
- charge depends on pH --> use buffer solution to keep constant pH
- proteins are usually negatively charged
- polypeptides separate due to different net charges

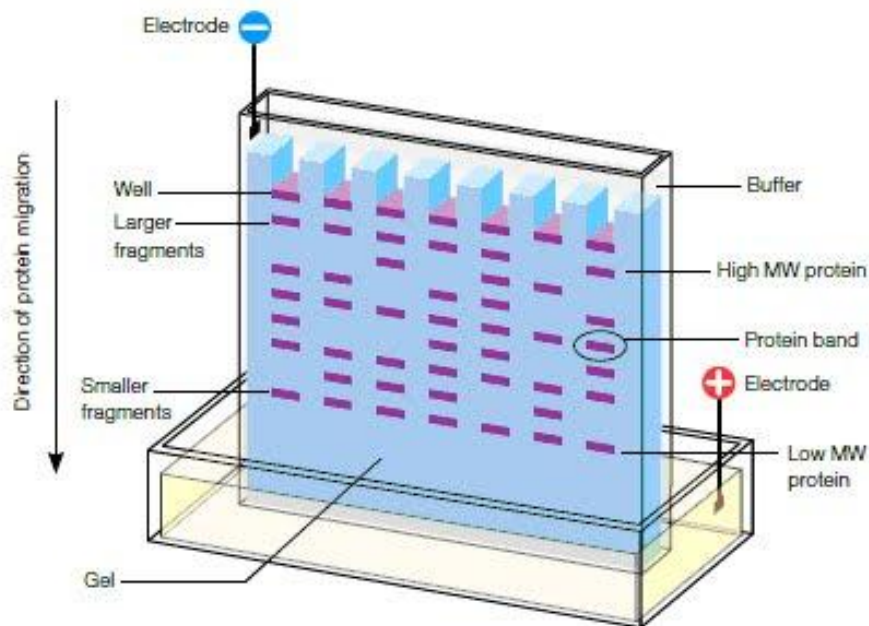

### Electrophoresis of DNA

- a region of DNA is chosen
- DNA is extracted
- DNA is chopped into pieces using **restriction endonucleases**
- fragments are transferred to absorbent paper --> placed onto gel --> heated to separate DNA strands
- "**probes**" (short sequences of single-stranded DNA) are added. They contain radioactive P isotopes --> X-ray results --> darken film, the separated fragments become visible

## #135 Genetic markers and microarrays

Genetic markers uses enzymes that produces **fluorescent** substances. There used to be **antibiotic resistance** gene markers, but there was the chance that they would spread the antibiotic resistance to other new strains of bacteria.

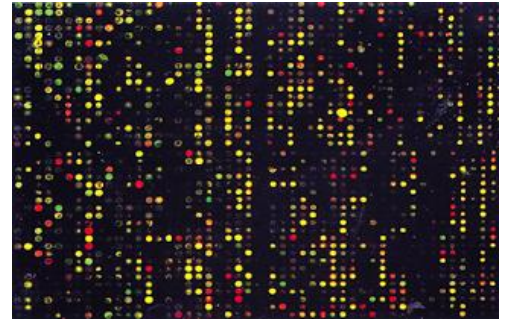

### Genetic markers

**Green fluorescent protein (GFP)** from jellyfish:

- gene inserted into plasmid --> taken up by bacteria
- shine **UV** light --> identify genetically modified bacteria

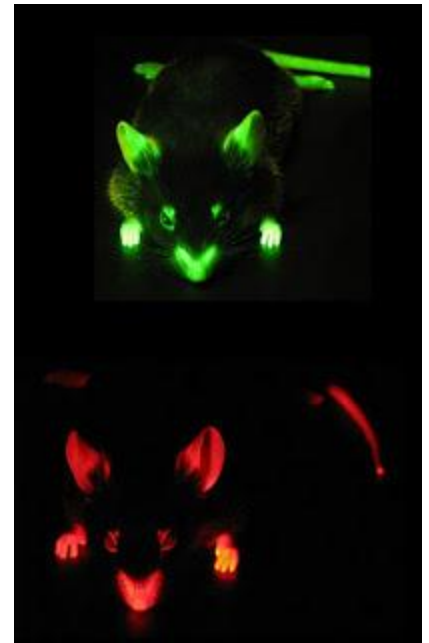

**$\beta$ -glucuronidase (GUS)** from E.coli:

- transform into incubated with colourless/non-fluorescent substrate
- > transform into coloured/fluorescent products
- > detect **activity** of inserted genes

### Microarray

- identify **genes** present in an organism's genome
- find out which genes are **expressed** within cells
- > microarrays contain thousands of gene probes

**1. Genome analysis:** **compare genes** present in two different species

- DNA collected from each species, cut to **fragments** and **denatured, labelled** with fluorescent tags
- DNA samples are mixed together and **hybridised** with DNA **probes** on the microarray --> inspected with **UV light**, causing the tags to fluoresce
  - colour: DNA has hybridised with probe
  - no colour: DNA not hybridised, gene not present

## 2. Gene expression - detecting mRNA

- to identify genes that are being transcribed to mRNA

- mRNA collected --> reverse transcriptase --> **cDNA**
- cDNA labelled with fluorescent tags, denatured, hybridised with probes on microarray
- spots that fluoresce microarrays show transcribed genes

\* **intensity** of light emitted from spots = level of activity of genes

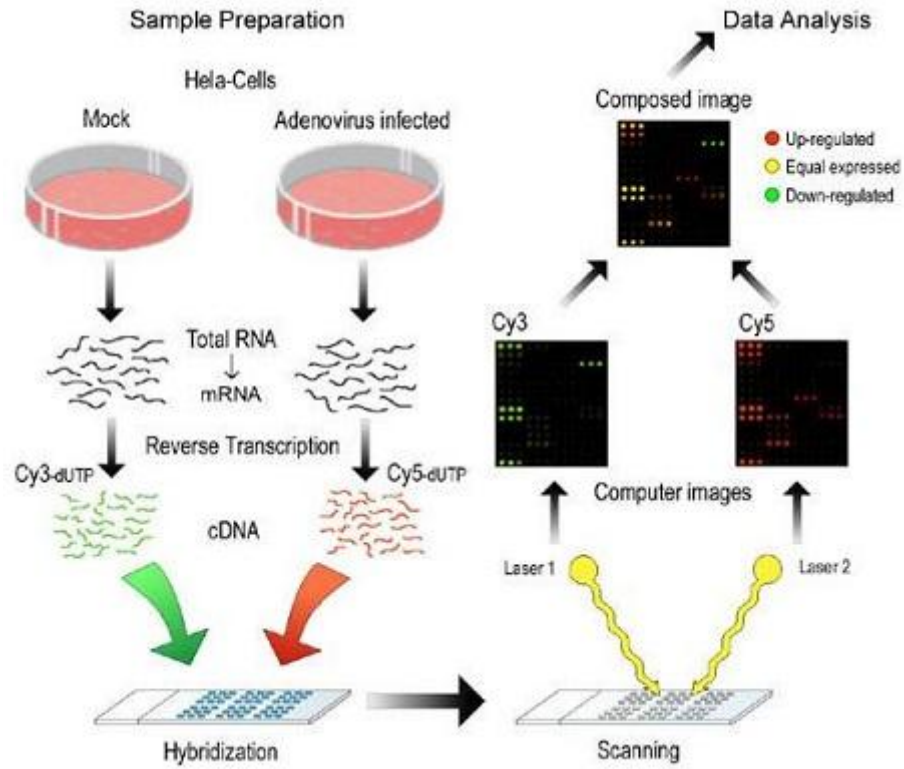

## #136 Bioinformatics

Bioinformatics is the **collecting**, **processing** and **analysis** of biological information and data using computer software.



Bioinformatics build databases which hold **gene sequences** and sequences of **complete genomes**. These sequences can be matched --> calculate **degrees of similarity** (close similarities indicate recent common ancestry)

- human genes may be found in other organisms and are used to model for investigating the way in which such genes have their **effects**
- e.g.: Plasmodium genome: used to find new methods to control parasites

---> reading the gene sequences provides information to develop vaccines for malaria

**Advantages** of using human proteins produced from recombinant DNA

### 1. Insulin

- **reliable** supply available for increasing demand
- is **not dependent** on factors e.g.: meat trade
- **acts faster** than animal insulin or **slower** over a long period of time

### 2. Factor VIII - genetically modified hamster cells produce factor VIII

- Factor VIII is extracted and purified before being used to treat patients with haemophilia
- **avoids the risk of infection** e.g.: HIV from donated blood

### 3. adenosine deaminase (ADA) - used to treat SCID (severe combined immunodeficiency disease)

- produced from genetically modified larvae of cabbage looper moth caterpillar  
- administered to patients when:

- waiting for gene therapy
- gene therapy is not possible

### #137 Genetic screening

Genetic screening: **analysis** of a person's DNA to check for the **presence** of a particular **allele**  
 \* available for adults, fetus, embryo,...



- **BRCA1 and BRCA2**: faulty alleles that lead to breast and ovarian **cancer** in females and breast cancer in males ---> elective vasectomy

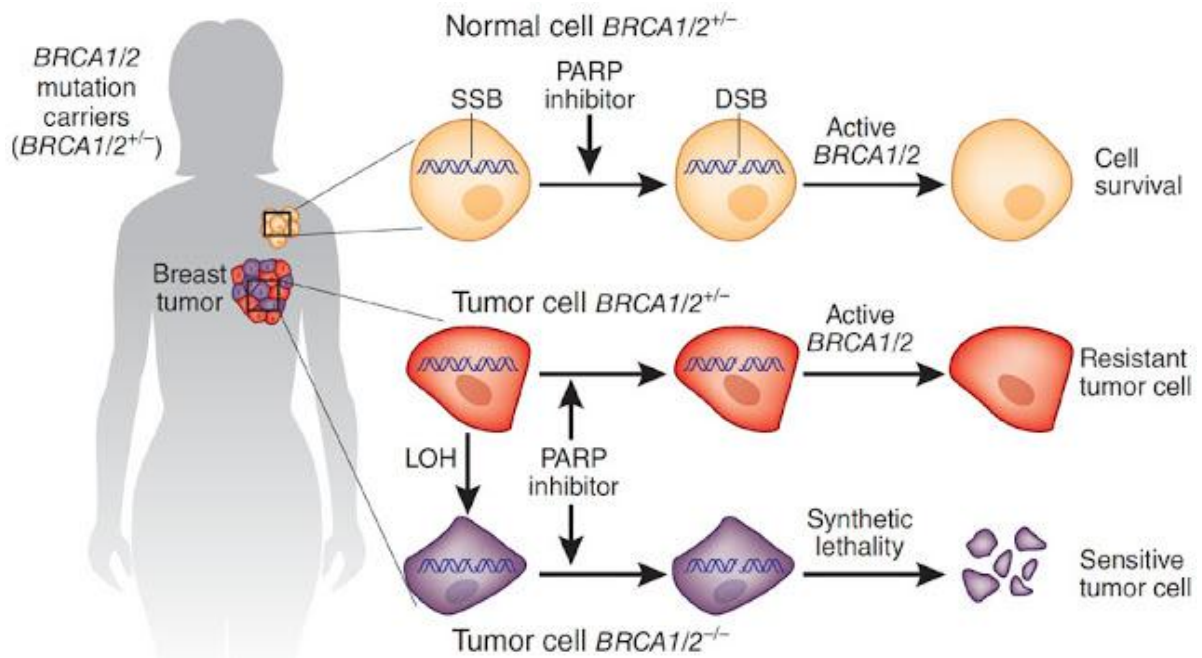

- **pre-implantation genetic diagnosis (PGD)**:

- carry out the IVF procedure (sperm and egg in a dish)
- when it reaches the 8-cell stage, remove one cell and analyse the DNA for **disease alleles**

- disease allele absent: embryo chosen for **implantation**

- disease allele present: embryo is **discarded**

---> avoid pregnancies with haemophilia, sickle cell anaemia, Huntington's disease, cystic fibrosis,...



- provides information about the increased **risks** of people having genetic conditions
- people **prepare** for the late onset of genetic conditions like Huntington's disease
- identify whether embryos from IVF will **develop genetic conditions**
- identify a fetus that needs **early treatment**
- helps provide **early diagnosis**

### Ethics of genetic screening

- fetus screening for genetic disease:
  - **amniocentesis**: look for chromosomal mutations
  - **chorionic villus sampling** (although there is an increased risk for miscarriage with this)
- **sex preselection**: terminates pregnancy if the embryo is of the wrong sex (used PGD to select)
- **therapeutic abortions**: terminating pregnancies for medical reasons



## #138 Gene therapy

Gene therapy: treatment of a genetic disorder by **altering** a person's **genotype** (insert functional alleles of genes into cells)



### Common vectors:

- **virus**: retrovirus, lentivirus, HIV, adeno-associated virus (AAV)
- **liposomes** - small spheres of phospholipids
- **naked DNA**

- retrovirus: inserts genes randomly into host's genome. If the gene is inserted into another gene or regulatory sequence of a gene, it could **activate a nearby gene** and cause cancer

- lentivirus: inserts genes randomly into host's genome, but this virus can be **modified to inactivate** replication e.g.: HIV

- adeno-associated virus (AAV): **does not insert** genes into host genome --> gene is not passed to daughter cells when a cell divides --> the virus can be used successfully with long-lived cells

### Structure of a retrovirus

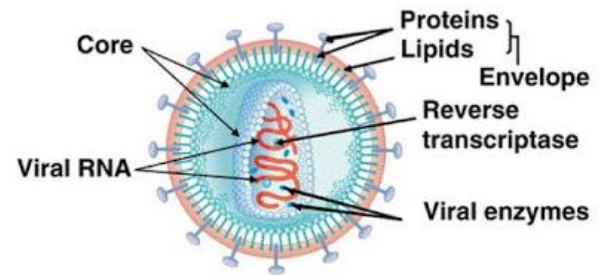

courtesy www.andrew.cmu.edu

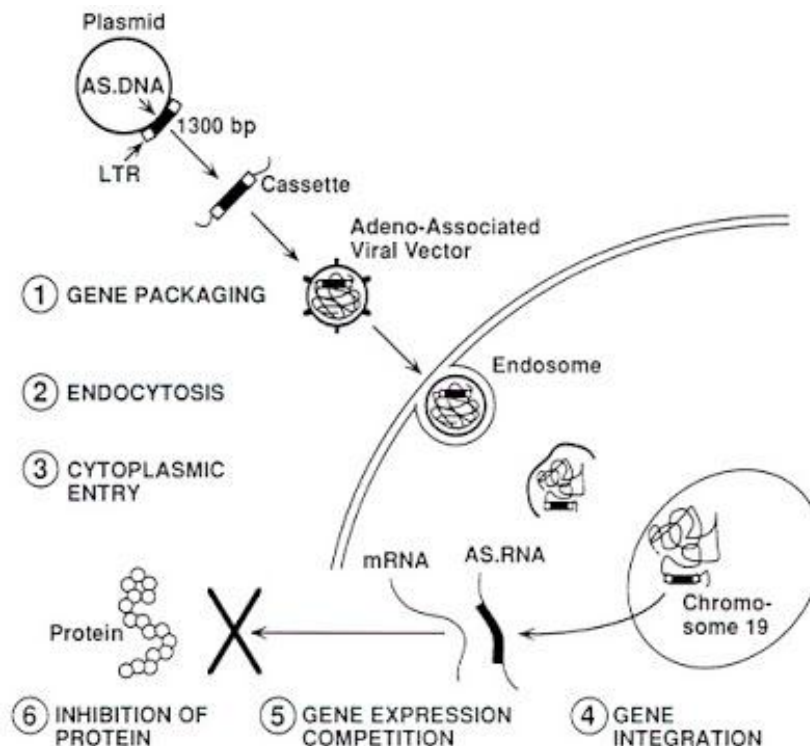

## Severe combined immunodeficiency (SCID)

- a crippled immune system
- sufferers may die at infancy due to normal infections
- inability to make **adenosine deaminase** (ADA)

--> T-lymphocytes of sufferers are removed and normal alleles of the ADA gene are introduced into them using a virus vector. This is not a permanent cure.



They call him bubble boy.

**Cystic fibrosis:** genetic disorder where abnormally **thick mucus** is produced in the lungs and other body parts. It is caused by a **recessive mutated** allele of the gene for a functional transporter protein for chloride ions.

- deletion mutation of 3 bases (AAA) in **CFTR gene**
- role of CFTR: transport chloride ions across epithelial cell membranes of the pancreas alveoli in the lungs,... --> water follows via osmosis across membranes as water potential decreased due to the entry of chloride ions --> membranes remain moist and runny
- sufferers of cystic fibrosis: CFTR non-functional --> water is retained inside cell --> results in dry membranes and sticky mucus

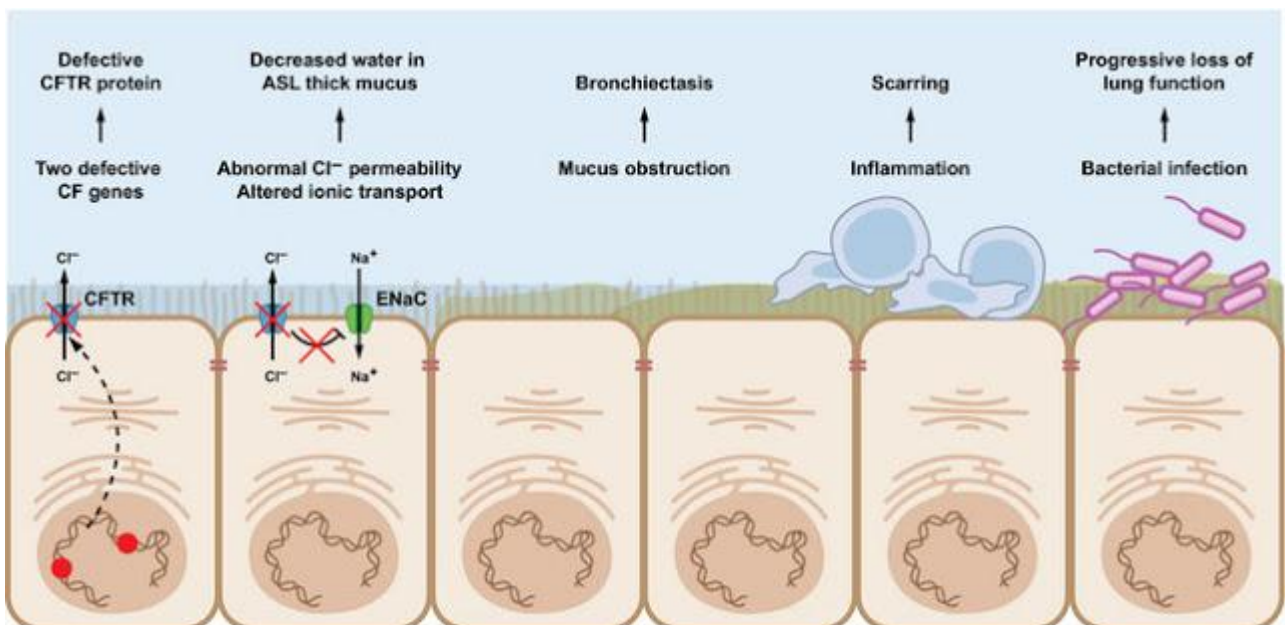

**Symptoms:**

- thick mucus accumulates in **lungs** --> breathing difficulties and higher risks of infections
- thick mucus blocks **pancreatic duct** and therefore blocks off oral enzymes that help digestion
- male infertility: thick mucus blocks **sperm ducts**

**Somatic and germ cell therapy**

- somatic cells = body cells
- germ cells = cells involved in sexual reproduction (alleles in the germ line are passed on through generations and generations)

**Applications**

- electrophoresis of DNA is used in genetic profiling (fingerprinting) in **forensic science**
- PCR is also used in forensic science to solve crimes: used to **amplify DNA** from small tissue samples

## #139 Genetically modified organisms

Genetic engineering is **improving** the **quality** (nutrition) and **yield** of crop plants and livestock --> therefore is solving the demand for food in the world



### 1. Golden Rice

- genetically modified rice produces large quantities of  **$\beta$ -carotene** in **endosperm** --> human cells convert  $\beta$ -carotene to Vitamin A
- Golden Rice has same yield, pest resistance and eating qualities as the original varieties
- normally:



- deficiency of Vitamin A can lead to blindness and death (due to a weak immune system)
- Vitamin-A is fat soluble: found in oily-fish, dairy, liver,...
- Pro-vitamin A is present in the aleurone layer, not in the endosperm in rice

-genes for carotene production is taken from: and inserted into rice

- **daffodils**
- common soil bacterium *Pantoea ananatis*

\*ethical implications?

Some organisations condemn Golden Rice: It is the **wrong way to solve poverty**. Solving political, cultural and economic issues will help lower poverty, as people will be given a more varied diet

From question 9a past paper of Winter 2014, paper 43

- 7 promoters added ;
- 8 plasmids put into *Agrobacterium tumefaciens* ;
- 9 *Agrobacterium tumefaciens* mixed with rice embryos ;
- 10 (some embryos) take up bacteria and vitamin A gene ; **A** gene gun
- 11 grow into adult plants ;
- 12 produce seeds with, vitamin A/carotene ;
- 13 in endosperm ;
- 14 AVP ; e.g. *ref. to Golden Rice™*

9 (a) Describe how the vitamin A content of rice can be enhanced by genetic modification.

- 1 vitamin A found in aleurone layer of rice (seeds) ; [8]
- 2 white rice does not contain, aleurone layer/vitamin A/carotenoids/ $\beta$  carotene ;
- 3 genes coding for vitamin A production extracted ;
- 4 from, bacteria/*Erwinia uredovora*/*Pantoea ananatis* ;
- 5 (and) daffodils/maize ;
- 6 inserted into plasmids/plasmid used as a vector ;

[http://papers.gceguide.com/A%20Levels/Biology%20\(9700\)/9700\\_w14\\_qp\\_43.pdf](http://papers.gceguide.com/A%20Levels/Biology%20(9700)/9700_w14_qp_43.pdf)

[http://papers.gceguide.com/A%20Levels/Biology%20\(9700\)/9700\\_w14\\_ms\\_43.pdf](http://papers.gceguide.com/A%20Levels/Biology%20(9700)/9700_w14_ms_43.pdf)

## 2. GM Atlantic salmon

Injected into a fertilised egg of an Atlantic salmon:

- **growth-hormone regulating** gene from a Pacific Chinook salmon
- **promoter** from another species of fish, an ocean pout

The salmon are able to grow all year, instead of just in spring and summer. They reach market size in 18 months as opposed to 3 years of an unmodified fish.

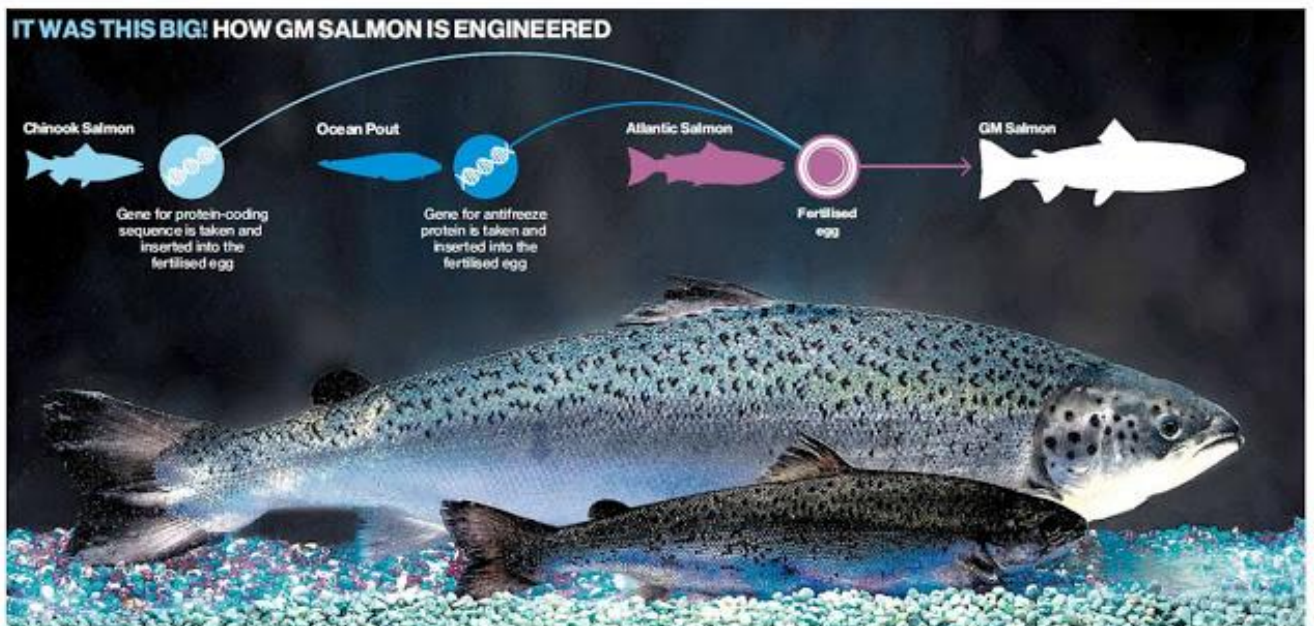

How GM salmon is engineered

## #140 Herbicide and insect resistant crops

Genetic technology can provide benefits in, for example, agriculture and medicine, but has the associated risk of the **escape of the gene** concerned into organisms other than the intended host.

### Herbicide resistant crops

Fields of crops are sprayed with herbicide to kill weeds that compete for space, light, water, and ions to **increase crop yield**.



### Oil seed rape

- a source of vegetable oil and biodiesel fuel
- modified oil seed rape is resistant to the herbicide **glyphosphate** (inhibits the synthesis of 3 amino acids: phenylamine, tyrosine, tryptophan)

- glyphosphate is absorbed through leaves and is transported to growing tips

- the gene transferred into crop plants come from a strain of the **bacterium** Agrobacterium



### Tobacco

- resistant to herbicides: sulfonylurea and dinitroaniline
- genes taken from other **plant species**

### Effects on the environment:

- the GMed plants become **agricultural weeds**
- pollen will transfer the gene to wild relatives, producing hybrid offspring that are **invasive weeds**
- **herbicide-resistant weeds** will evolve because so much of the same herbicide is used

### Insect-resistant crops

To protect crop plants against insect pests to **increase crop yield**

**Cotton** - protected against boll weevil

**Bt maize** - protected against corn borers



- Bt toxing is - lethal to insects that eat it
  - harmless to other animals
- gene for Bt toxin is taken from the **bacterium** *Agrobacterium tumefaciens*
- genetically modified crop plants with Bt toxin gene **produce their own insecticides**
- Bt resistance in corn borers: **recessive allele**. Adult corn borers in refuges (non GM maize) supply the dominant allele to counteract the resistance when they mate with borers from the fields

#### Effect on environment:

- **evolution of resistance** by insect pests
- **damaging effects** on other insect species
- **transfer** of added **gene** to other plant species

### #141 Social implications of GMO

There are social implications related to using genetically modified organisms in food production.



- modified crop plants become agricultural weeds and invade crop habitats
- introduced gene(s) may be transferred by pollen:
  - to **wild relatives** --> more invasive hybrid offspring
  - to **unmodified plants** on farms with organic certification
- modified plants can be **toxic** and **produce allergies** --> fatal to humans and animals that eat it
- **herbicides** will leave **toxic residues** on crops
- genetically modified seeds are **as expensive** as herbicides --> no advantage
- growers need to **buy new seeds** every season
- loss of traditional varieties

## #142 Summary of Genetic technology

1 Gene technology involves altering the genes in an organism, which is then said to be genetically modified.

2 The usual way of genetically modifying bacteria is to insert a plasmid containing the desired gene into them.



3 The steps involved in the production of bacteria capable of synthesising human insulin are:

- identifying the human insulin gene;
- isolating mRNA and making cDNA using reverse transcriptase;
- cloning the DNA using DNA polymerase;
- inserting the DNA into a plasmid vector using restriction enzymes and DNA ligase;
- inserting the plasmid vector into the host bacterium;
- identifying the genetically modified bacteria;
- cloning the bacteria; and harvesting the human insulin.

4 The main advantage of treating diabetics with human insulin produced by gene technology is that it is chemically identical to the insulin that they would have produced had they not been diabetic. It also avoids any ethical issues that may arise from the use of insulin derived from an animal.

5 A promoter must be inserted along with the gene, because bacteria will not express a gene unless a suitable promoter is present.

6 The bacteria that have taken up the gene can be identified using resistance to antibiotics or the presence of a fluorescing protein as markers.

7 Gene technology can provide benefits in, for example, agriculture, medicine and industry, but has the associated risk of the escape of the gene concerned into organisms other than the intended host. The risk is seen to be particularly high for genetically modified crops that are released into the environment to grow.

8 The social implications of gene technology are the beneficial or otherwise effects of the technology on human societies.

9 Ethics are sets of standards by which a particular group of people agree to regulate their behaviour, distinguishing an acceptable from an unacceptable activity. Each group must decide, first, whether research into gene technology is acceptable, and then whether or not it is acceptable to adopt the successful technologies.

10 Electrophoresis is a technique that can be used to separate lengths of DNA (or RNA or proteins) of different sizes by applying an electric current to them. Small fragments move faster and therefore further than large ones, and can be made visible using radioactive labels or fluorescent compounds. Electrophoresis is used in genetic profiling (genetic fingerprinting) and in DNA sequencing.



11 Cystic fibrosis is a genetic disease caused by a recessive allele of the gene that codes for the production of a chloride transporter protein called CFTR. People with two copies of the recessive allele produces thick, sticky mucus in their lungs, pancreas and reproductive organs.

12 Several attempts have been made to insert normal alleles of the CFTR gene into people with cystic fibrosis, a process called gene therapy. So far, there has been only limited success, because it is difficult to get the alleles into the cells. Even when this is successful, it needs to be repeated at frequent intervals because the cells have a very short natural lifespan.

13 Genetic screening involves testing people to find out if they carry any faulty alleles for genes that can cause disease. Genetic counsellors may help people who find that they have a disease-causing allele, or that their unborn child has, to make a decision about how to act on this information.

### 1. End-of-chapter questions

1 Different enzymes are used in the various steps involved in the production of bacteria capable of synthesising a human protein. Which step is catalysed by a restriction enzyme?

- A cloning DNA
- B cutting open a plasmid vector
- C producing cDNA from mRNA
- D reforming the DNA double helix

2 What describes a promoter?

- A a length of DNA that controls the expression of a gene
- B a piece of RNA that binds to DNA to switch off a gene
- C a polypeptide that binds to DNA to switch on a gene
- D a triplet code of three DNA nucleotides that codes for 'stop'

3 Which statement correctly describes the electrophoresis of DNA fragments?

- A Larger fragments of DNA move more rapidly to the anode than smaller fragments.
- B Positively charged fragments of DNA move to the anode.
- C Small negatively charged fragments of DNA move rapidly to the cathode.
- D Smaller fragments of DNA move more rapidly than larger fragments.

4 The table shows enzymes that are used in gene technology. Copy and complete the table to show the role of each enzyme.

Enzyme	Role
DNA ligase	
DNA polymerase	
restriction enzymes	
reverse transcriptase	

**5** Rearrange the statements below to produce a flow diagram showing the steps involved in producing bacteria capable of synthesising a human protein such as human growth hormone (hGH).

1. Insert the plasmid into a host bacterium.
2. Isolate mRNA for hGH.
3. Insert the DNA into a plasmid and use ligase to seal the 'nicks' in the sugar-phosphate chains.
4. Use DNA polymerase to clone the DNA.
5. Clone the modified bacteria and harvest hGH.
6. Use reverse transcriptase to produce cDNA.
7. Use a restriction enzyme to cut a plasmid vector.

**6 a** Genetic fingerprinting reveals the differences in variable number tandem repeats (VNTRs) in the DNA of different individuals. Explain what is meant by a VNTR. **[3]**

**b** Examine the figure, which shows diagrammatic DNA profiles of a mother, her child and a possible father of the child. Decide, giving your reasons, whether the possible father is the actual father of the child. **[3]**

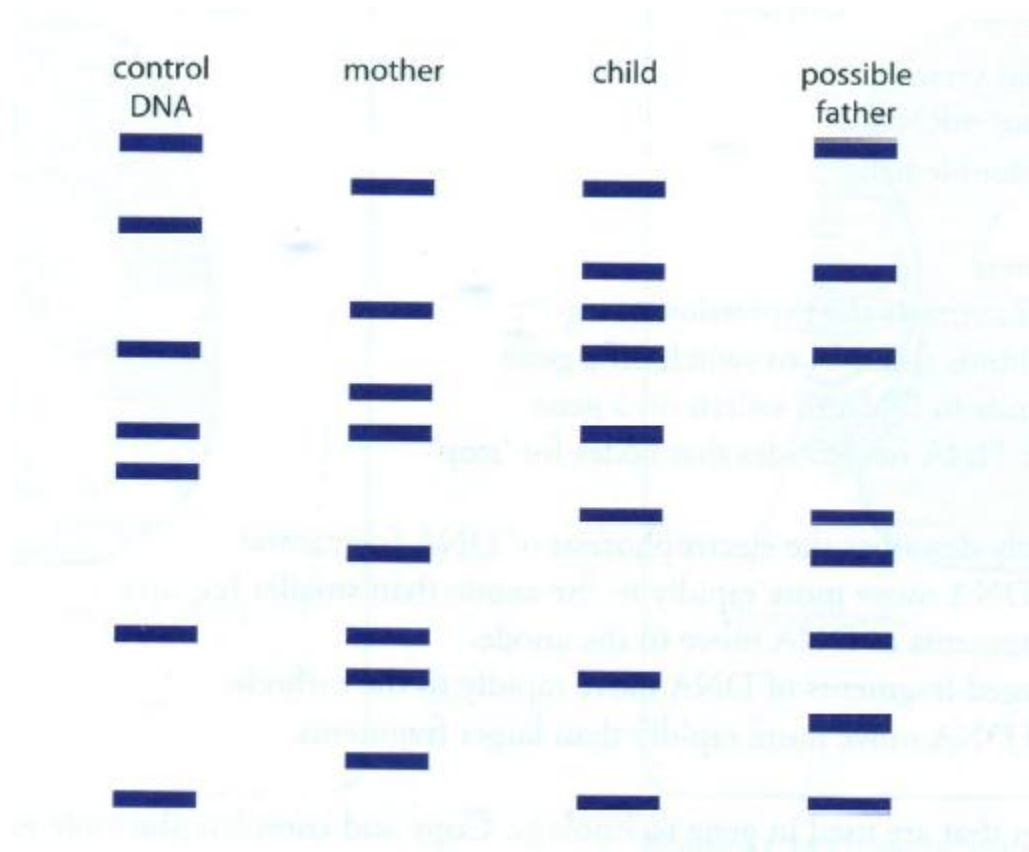

[Total: 6]

7 a Copy and complete the table to explain the roles of primers and dideoxynucleotides in DNA sequencing.

Molecule	Description	Role
primer	A short length of DNA with complementary coding to the start of the gene.	
DNA nucleotides	Each consists of deoxyribose sugar, a nitrogenous base and a phosphate group.	
dideoxynucleotide	i A doubly deoxygenated nucleotide. ii Each is tagged with a fluorescent dye, with different colours for A, C, G and T.	

3]

b Explain what is meant by:

- i gene therapy [1]
- ii genetic screening [1]
- iii genetic counselling. [1]

c Explain why it is easier to devise a gene therapy for a condition caused by a recessive allele than for one caused by a

dominant allele. [5]

[Total: 11]

**8 a** Draw a genetic diagram to show how two heterozygous parents may produce a child with cystic fibrosis. Use the symbols **A/a** in your diagram. [3]

**b** State the probability of one of the children of these parents suffering from cystic fibrosis. [1][Total: 4]

The figure shows the CFTR (cystic fibrosis transmembrane conductance regulator) protein in a cell surface membrane.

**a i** Describe the normal function of the CFTR protein. [2]

**ii** Use the letter E to indicate the external face of the membrane

State how you identified this face. [1]

**b** Cystic fibrosis is caused by a recessive allele of the CFTR gene.

**i** Explain the meaning of the term recessive allele. [2]

**ii** Explain how cystic fibrosis affects the function of the lungs. [3]

**c** As cystic fibrosis is caused by a recessive allele of a single gene, it is a good candidate for gene therapy. Trials were undertaken in the 1990s, attempting to deliver the normal allele of the CFTR gene into cells of the respiratory tract, using viruses or liposomes as vectors. Explain how viruses deliver the allele into cells. [2]

**d** In some people with cystic fibrosis, the allele has a single-base mutation which produces a 'nonsense' (stop) codon within the gene.

**i** Explain how this mutation would prevent normal CFTR protein being produced. [2]

**ii** A new type of drug, PTC124, enables translation to continue through the nonsense codon. Trials in mice homozygous for a CFTR allele containing the nonsense codon have found that animals treated with PTC124 produce normal CFTR protein in their cells. The drug is taken orally and is readily taken up into cells all over the body.

Using your knowledge of the progress towards successful gene therapy for cystic fibrosis, suggest why

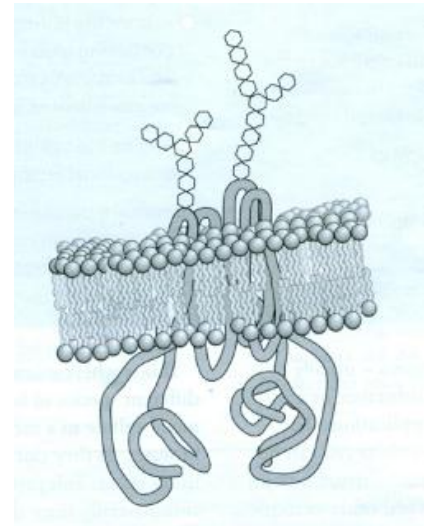

PTC124 could be a simpler and more reliable treatment for the disease. [3]

[Total: 15]

[Cambridge International AS and A Level Biology 9700/04, Question 2, October/November 2008]

## 2. End-of-chapter answers

1 B 2 A 3 D

4

Feature	Role
DNA ligase	joining gaps in sugar–phosphate chains of DNA
DNA polymerase	replicates DNA
restriction enzymes	cut DNA at specific sites
reverse transcriptase	make cDNA from mRNA

5 2, 6, 4, 7, 3, 1, 8, 5

**6 a VNTR:** a short length of highly repetitive DNA; number of repeats and hence lengths of repeats differ markedly in different individuals; inherited: half VNTRs from father, half from mother; only identical twins have the same VNTRs; [max. 3]

**b** four bands in child's profile match four of the bands in the mother's; the other four bands match four bands in the father's profile; the possible father is the actual father; [3] [Total: 6]

7 a

Molecule	Description	Role
primer	a short length of DNA with complementary coding to the start of the gene	binds to start of gene so that replication can continue from the primer
DNA nucleotides	each consists of deoxyribose sugar, a nitrogenous base and a phosphate group	needed for DNA replication, each binds to its complementary base
dideoxynucleotide	<b>i</b> a doubly deoxygenated nucleotide <b>ii</b> each is tagged with a fluorescent dye, with different colours for A, C, G and T	(i) stops the replication wherever one happens by chance to be added to the growing chain (ii) identifies the end of each fragment and allows process to be automated, the tag colour is recorded by a computer

[3]

**b i gene therapy:** treatment of a genetic disorder by altering the patient's genotype; [1]

**ii genetic screening:** determination of a person's genotype using karyotype analysis for chromosome mutations and probes for identifying particular alleles; [1]

**iii genetic counselling:** a service that seeks to explain the nature of genetic disorders and probability of their transmission; [1]

**c** when a genetic disorder is caused by a recessive allele, the 'normal' allele is dominant;

adding a dominant allele allows some correct product to be made; the individual effectively becomes heterozygous;

the recessive allele may code for defective product or no product;

production of some correct product may cure the disorder;

adding a recessive allele cannot block a faulty dominant allele; **[max. 5] [Total: 11]**

**8 a**

Gametes	A	a
A	AA normal	Aa carrier
a	Aa carrier	aa cystic fibrosis

correct gametes; correct genotypes; correct phenotypes; **[3]**

**b** 1 in 4/0.25/25%; **[1] [Total: 4]**

**9 a i** chloride channel; chloride moves out of cell by active transport; **[2]**

**ii** upper face because of presence of carbohydrate chains; **[1]**

**b i** allele: variant form of a gene; recessive: only affects phenotype when dominant allele is not present; **[2]**

**ii** thick, sticky mucus produced; mucus accumulates; reduced gas exchange; more infections; **[max. 3]**

**c** normal dominant CFTR allele added to viral DNA;

virus inserts DNA into cell; **[2]**

**d i** translation stopped at 'stop' codon; protein chain not completed; **[2]**

**ii** comparisons include: drug easily taken up by cells, whereas therapy is poorly taken up;

drug taken orally, whereas therapy must be inhaled into lungs;

no vector needed for drug, whereas virus vector for therapy may cause side-effects; **[3] [Total: 15]**